



[RDL](#)

[Document](#)

[Download](#)

[Homepage](#) [Information](#) [Instructions](#)

---

## \*FM 3-101

**Headquarters  
Department of the Army  
Washington, DC  
19 November 1993**

# FM 3-101

# CHEMICAL STAFFS AND UNITS

[MEMORANDUM](#), SUBJECT: Request to Change  
Chemical Proponent Field Manual Distribution Restriction  
Statements, 6 October 2000, with 12 October 2000 e-mail  
endorsement.

## ***Table of Contents***

---

**[PREFACE](#)**

**[INTRODUCTION](#)**

**CHAPTER 1 - CHEMICAL UNIT AND STAFF ORGANIZATIONS**

**CHAPTER 2 - CHEMICAL UNIT EMPLOYMENT CONCEPTS**

**CHAPTER 3 - CHEMICAL UNIT PLANNING**

**CHAPTER 4 - BATTLE COMMAND**

**CHAPTER 5 - CHEMICAL STAFF'S & UNIT'S ROLES IN FORCE PROJECTION**

**CHAPTER 6 - OPERATIONS OTHER THAN WAR**

**CHAPTER 7 - OFFENSIVE OPERATIONS**

**CHAPTER 8 - DEFENSIVE OPERATIONS**

**CHAPTER 9 - REAR OPERATIONS**

**CHAPTER 10 - SUSTAINMENT OPERATIONS**

**APPENDIX A - CHEMICAL UNIT ORGANIZATIONS**

**APPENDIX B - CHEMICAL BRIGADE/BATTALION STAFF OPERATIONS**

**APPENDIX C - NBC STAFF DUTIES AND RESPONSIBILITIES**

**APPENDIX D - THE MILITARY DECISION MAKING PROCESS (MDMP)**

**APPENDIX E - NBC INTELLIGENCE PREPARATION OF THE BATTLEFIELD**

## [APPENDIX F - ORDERS AND PLANS](#)

## [GLOSSARY](#)

## [REFERENCES](#)

## [AUTHORIZATION LETTER](#)

---

**DISTRIBUTION RESTRICTION: Approved for public release; distribution is unlimited.**

\* This publication supersedes FM 3-101, 22 April 1987.



[RDL](#) [Table of](#) [Document](#) [Download](#)

[Homepage](#) [Contents](#) [Information](#) [Instructions](#)

---

-----Original Message-----

From: Washington, Lawrence [mailto:washingl@monroe.army.mil]

Sent: Thursday, October 12, 2000 9:23 AM

To: Hauser, Ed

Identifying information added

[Chief, Publications Section

US Army Training Support Center

ATTN: ATIC-TMSD-T

(757) 878-4669 DSN 927-4669

[hausere@atsc.army.mil](mailto:hausere@atsc.army.mil)]

Cc: Chalkley, Randall; Williams, Richard P; Wales, Scott; Wallace, Steve, LTC; Warner, Mark COL; 'kempc@wood.army.mil'; Watkins, Dave, LTC  
Subject: FW: Chemical Proponent Field Manual Restricted Distro Statements

Ed

The attachment contains the Chemical Schools request for change to the restriction statements in selected FMs and TCs. The Chemical School is the proponent for these publications and have the authority to make the appropriate changes based on their analysis.

Lawrence Washington  
Joint and Army Doctrine  
757-727-3454/DSN 680-3454

---



**DEPARTMENT OF THE ARMY**  
**US ARMY CHEMICAL SCHOOL**  
**FORT LEONARD WOOD, MISSOURI 65473-8926**

REPLY TO  
ATTENTION OF

ATSN-CM-DD (25-30)

6 October 2000

MEMORANDUM FOR: Commander, US Army Training and Doctrine Command, ATTN: Deputy Chief of Staff for Doctrine (ATDO-A), Fort Monroe, VA 23651-5000

SUBJECT: Request to Change Chemical Proponent Field Manual Distribution Restriction Statements

1. Reference. Army Regulation 25-30, The Army Publication and Printing Program, July 99.
2. Request approval to change the distribution restriction for the manuals identified in Table 1 ([Enclosure 1](#)) from Statement B (US Government agencies only) to Statement A (Approved for public release).
3. As proponent for these manuals, the U.S. Army Chemical School (USACMLS) has carefully considered the provisions of AR 25-30, Section 2-14, paragraph c in preparing this request. Our belief is that although the referenced regulation proscribes that manuals containing information on "chemical warfare" should not be approved for public release, it is our interpretation that this provision was intended to deal with aspects of offensive chemical warfare, an aspect no longer a part of any US Army doctrine.
4. The USACMLS believes that changing the distribution restriction for these manuals will increase NBC readiness for Army forces and will contribute to U.S. counterproliferation efforts. By changing the distribution restriction, Army personnel will have ready, unimpeded access to these critical documents through such means as the Reimer Digital Library and the USACMLS web page. It will allow more open and productive dialogue during the development of these manuals. We also believe that the open distribution of this doctrine under the provisions of Statement A will permit potential adversaries to perceive the U.S.'s robust capabilities to operate in an NBC environment which will deter the adversary's use of NBC weapons and thus directly contribute to U.S. policy for counterproliferation.
5. In accordance with AR 25-30, request the manuals in Table 2 (Enclosure 1) that are restricted distribution statement B (US Government agencies only) be changed to restricted distribution statement C (US Government agency's and their contractors) to protect technical and operational information. It is our belief that these manuals still reveal limitations on U.S. chemical and biological defenses that should not be available for public release, however we do acknowledge that these documents should be made available to U.S. Government contractors who are assisting in developing NBC defense capabilities.

6. The USACMLS points of contact for this project are LTC Flanagan and CPT Kemp, DSN 676-7363/7364, commercial (573) 596-0131 ext 37363/37364, fax (573)563-8063, e-mail: [flanagac@wood.army.mil](mailto:flanagac@wood.army.mil) and [kempc@wood.army.mil](mailto:kempc@wood.army.mil).

*Original signed*

Encl PATRICIA L. NILO  
COL, CM  
Commandant

---

Enclosure 1. Manual List

**Table 1. Manuals for Public Release; Distribution is Unlimited**

<b>Manual</b>	<b>New Number</b>	<b>Title</b>
FM 3-3	FM 3-11.3	Biological and Chemical Contamination Avoidance
FM 3-3-1	To be rescinded	Nuclear Contamination Avoidance
FM 3-4	FM 3-11.4	NBC Protection
FM 3-4-1	FM 3-11.34	MTTP for NBC Defense of Fixed Sites, Ports, and Airfields
FM 3-5	FM 3-11.5	NBC Decontamination
FM 3-6	FM 3-11.6	Field Behavior of NBC Agents
FM 3-7	FM 3-11.7	NBC Handbook
FM 3-11	FM 3-11.11	Flame, Riot Control Agents, and Herbicide Operations

FM 3-14	FM 3-11.14	Vulnerability Analysis
FM 3-19	FM 3-11.19	NBC Reconnaissance
FM 3-50	FM 3-11.50	Smoke Operations
FM 3-100	FM 3-11	Chemical Operations, Principles and Fundamentals
FM 3-101	FM 3-11.100	Chemical Staffs and Units
FM 3-101-1	FM 3-11.101	Smoke Squad/Platoon Operations
TC 3-8	TC 3-11.8	Chemical Training
TC 3-10	TC 3-11.10	Commander's Tactical NBC Handbook

**Table 2. Manuals for Distribution Authorized to US Government Agencies and Their Contactors**

<b>Manual</b>	<b>New Number</b>	<b>Title</b>
FM 3-9	FM 3-11.9	Potential Military Chemical/Biological Agents and Compounds
FM 3-101-4	FM 3-11.112	Biological Detection Platoon TTP
FM 3-101-6	FM 3-11.86	Biological Defense Company and Corps Staff TTP



[RDL](#) [Table of Contents](#) [Document](#) [Download](#)

[Homepage](#) [Contents](#) [Information](#) [Instructions](#)

---

## PREFACE

Success on the battlefield demands a thorough understanding of enemy capabilities, tactics, and intent. It also requires leadership and decisive action. It is impossible to predict when or where nuclear, biological, and chemical (NBC) weapons may be used on future battlefields, however, we must accept the fact that many of our potential enemies have an NBC capability and intend to use NBC weapons.

When confronted with a NBC environment, unit leaders face major decisions. They must be able to define decontamination, smoke, and NBC reconnaissance requirements and request the support required to support the mission. This also includes providing direction for use of these assets. The chemical infrastructure provides experts at all levels of command to develop plans and advise commanders on the hazards associated with operating in a NBC environment. These experts also advise commanders on the employment of chemical assets to enhance the supported unit's survivability and combat power. Also, commanders have combat support units for detection, identification, and decontamination of NBC contamination. Smoke unit assets also are available to enhance the supported unit's survivability and combat power.

This field manual prescribes the doctrine for chemical staff sections and unit employment. It prescribes the fundamental principles for chemical staff functions, command and control of chemical units, and chemical unit employment. These principles are authoritative but require judgment in their application. For detailed procedures for chemical unit operations and NBC defense measures, see the following manuals: FM 3-3, FM 3-3-1, FM 3-4, FM 3-5, FM (J) 3-6, FM 3-13, FM 3-19, FM 3-50, and FM 3-100.

FM 3-101 is intended for chemical staff members and units plus battalion commanders and staff personnel. It is the foundation for service school instruction on chemical unit organization and operation.

Unless otherwise stated, whenever the masculine gender is used, both men and women are included.

This publication was prepared by the U.S. Army Chemical School; the proponent is TRADOC. Submit changes for improving this publication on a DA Form 2028 (Recommended Changes to Publications and Blank Forms) and forward it to:

Commandant  
U.S. Army Chemical School  
ATTN: ATZN-CM-FNB  
Fort McClellan, AL 36205-5020



[RDL](#)[Table of](#)[Document](#)[Download](#)[Homepage](#)[Contents](#)[Information](#)[Instructions](#)

## INTRODUCTION

Chemical staffs and units provide necessary support to units. The chemical staffs provide expertise on NBC defense, employment of chemical units, and smoke and flame operations. Chemical units provide equipment decontamination support, generate large-area smoke screens, and detect and identify NBC agents.

The employment and task organization of chemical units will be dictated by mission, enemy, terrain, troops, and time available (METT-T). Each mission and situation must be analyzed to determine the optimum scheme of support. There are no 'cookie cutter' approaches to developing the scheme of support and the command and support relationships of the supporting chemical units. Chapter 2 discusses general concepts for the employment of chemical units on the battlefield. Chapter 3 provides information on chemical unit planning. Chapter 4 talks about the various command and support relationships and how command and control is exercised over chemical units. These three chapters provide the basis for the employment and command and control of chemical units on the battlefield. To fully understand the principles of employing chemical units on the battlefield, the reader must read and understand each of these chapters in order.

The role and functions of the chemical staff are discussed throughout the manual. Chapter 1 discusses the organization of the various chemical staffs in the Army. Appendix D provides a detailed explanation of the duties and responsibilities of the chemical staff officers and NCOs. The various chemical organizations are discussed in Chapter 1 with more detail on their structure and equipment authorizations in Appendix A.

How chemical units are employed during operations across the range of military operations is discussed in Chapters 5, 6, 7, and 8. Chemical staff considerations are also discussed in detail in these chapters.

Chemical staffs and units could be the difference in winning or losing on the battlefield. This is accomplished by combining current NBC doctrine, defense equipment and skills with technical expertise. Through proper employment, chemical staffs and units will allow commanders to make timely decisions, maximize their combat power, and minimize the degradative effects of NBC contamination.

The commander must rely on his chemical staff for information on—

- The enemy's NBC weapon capabilities and intent for use.
- Ways to minimize the effects of NBC contamination.
- Available chemical unit assets, support capabilities they possess, and proper employment.

Additionally, this manual provides commanders at all levels information concerning how chemical units are commanded, controlled, employed, and sustained on the battlefield.



[RDL](#) [Table of](#) [Document](#) [Download](#)

[Homepage](#) [Contents](#) [Information](#) [Instructions](#)

---

## CHAPTER ONE

# CHEMICAL UNIT AND STAFF ORGANIZATIONS

This chapter describes the organization and functioning of chemical units (brigade to team) and chemical staffs (theater army to battalion). The primary focus of this manual is warfighting, however chemical units and battle staffs may be employed in operations other than war ([chapter 6](#))

## CHEMICAL UNITS

The mission of chemical units is to provide decon, NBC reconnaissance, large-area smoke, and staff support to commanders to enhance their warfighting capabilities or support contingency requirements. Most chemical units are 100 percent mobile. Basis of allocation is determined on the number and type of units being supported and METT-T. [Appendix A](#) provides details of specific unit organization.

## CHEMICAL BRIGADE

The chemical brigade normally supports a corps and consists of a brigade headquarters and headquarters company (HHC) and two to six chemical battalions. The brigade HHC consists of the brigade headquarters, containing the commander's immediate staff (S1, S2, S3, S4, and communications) and the headquarters company, which provides administrative and logistical support to the headquarters.

The chemical brigade commander, with the advice of his staff and the corps chemical section, evaluates and determines the chemical unit support requirements for the corps. The brigade commander advises the corps commander concerning the employment of chemical assets. The brigade staff develops the scheme of support based on the NBC situation and METT-T.

The brigade HHC is 50 percent mobile and provides its own organizational maintenance and mess support and establishes and operates internal and external radio and wire communications nets. The chemical brigade headquarters normally receives logistical support from a corps support group (CSG) designated in the corps operations order or plan (OPORD/OPLAN). The corps support command (COSCOM) provides points of contact for all classes of supply, maintenance, and field services.

## **CHEMICAL BATTALION**

The chemical battalion consists of a battalion headquarters and headquarters detachment (HHD) and two to five chemical companies. The battalion headquarters contains the battalion commander's principal staff (S1, S2/3, S4) and the headquarters detachment, which provides administrative and logistical support to the headquarters.

There are two types of chemical battalion headquarters. One is designed to operate as part of a chemical brigade. The other, the chemical battalion (enhanced) (theater army), is designed to be assigned to a theater army area command (TAACOM), and to be the senior chemical headquarters in that command.

The roles, functions, and responsibilities of the chemical battalion are directly affected by the command or support relationship established with the supported unit (see [chapter 4](#), Battle Command). When a chemical battalion is attached or under the operational control of a division, the division chemical officer may relinquish operational control of the division's assigned chemical company to the chemical battalion. This establishes a single point of contact for chemical unit support.

The HHD is 50 percent mobile and provides its own organizational maintenance and mess support and establishes and operates internal and external radio and wire communications nets. The chemical battalion (enhanced)(theater army) will normally receive support from an area support group (ASG). The ASG provides points of contact for all classes of supply, maintenance, and field services.

## **CHEMICAL COMPANIES**

### **Chemical Decontamination Company**

The chemical decon company provides equipment decon support to units. The company consists of a company headquarters, a maintenance section, and five decon platoons. The company is 100 percent mobile. Each decon platoon is organized with a platoon headquarters and three decon squads. The decon squads are equipped with the M12A1 power-driven decon apparatus (PDDA).

The company may provide decon support to units in a corps' rear area, the communications zone (COMMZ), or a division's area of operations (AO). The company may also provide specialized decon support such as aircraft or terrain decon. [FM 3-5](#), *NBC Decontamination*, provides detailed information concerning decon operations.

### **Motorized Smoke Generator Company**

The motorized smoke generator company provides large-area smoke support for tactical operations. The company consists of a company headquarters, a maintenance section, two smoke platoons, and a support platoon. The company is 100 percent mobile. Each smoke platoon is organized with a platoon headquarters, and three smoke squads. The smoke squads are equipped with the motorized smoke system. The support platoon may operate in a centralized or decentralized mode. When the company is organized to conduct company-level smoke operations, the support platoon operates as a platoon under the control of the support platoon leader. In decentralized operations, smoke platoons operate independently with support squads task-organized to each platoon under control of the smoke platoon leader.

The motorized smoke company is normally assigned to a chemical battalion, but may operate in direct support to a division. Motorized smoke units are less survivable than mechanized smoke units. This must be considered when determining how far forward motorized smoke units will operate.

The smallest deployable element of the company is a platoon. A motorized smoke platoon can create a smoke haze from 1,100 to 2,800 meters in width. [FM 3-50](#), *Smoke Operations* provides more detailed information concerning smoke operations.

### **Mechanized Smoke Generator Company**

The mechanized smoke company provides large-area smoke support for tactical operations in the forward combat area. The company consists of a company headquarters and two smoke platoons. The company is 100 percent mobile. Each platoon consists of a platoon headquarters, two smoke squads, and a support squad. The smoke squads are equipped with M1059 mechanized smoke vehicles. The M1059 allows them to provide more responsive smoke support to armored and mechanized infantry units.

The smallest deployable element of the mechanized company is a platoon. One platoon can create a smoke haze from 600 to 1,500 meters in width. Survivability of the fuel support platoon/ squads must be taken into consideration during planning. [FM 3-50](#), *Smoke Operations* provides detailed information concerning smoke operations.

### **Smoke/Decontamination Company**

The smoke/decon chemical company (corps/theater army) provides large area smoke and equipment decon support to divisions, units in the corps rear areas, or COMMZ. The company consists of a company headquarters and four smoke/decon platoons. The company is 100 percent mobile. Each platoon consists of a platoon headquarters, two smoke/decon squads, and a fuel/water support squad. The smoke/decon squads are equipped with M17 lightweight decon systems (LDS) and motorized smoke system. Each support squad can haul 2,400 gallons of water and 1,100 gallons of fog oil.

Each platoon can provide equipment decon and large area smoke generation support, however, the platoons cannot perform these missions simultaneously. Platoons cannot immediately switch from one mission to the other and must plan changes to mission configuration in detail.

A platoon can provide smoke haze from 550 to 1,400 meters in width. When the platoon is configured for decon support it can establish two operational decon sites or one thorough decon site.

### **NBC Reconnaissance Company**

The NBC reconnaissance company provides NBC reconnaissance support through the area of operations to locate, identify, mark, report NBC contamination, and identify bypass routes around contaminated areas. The company has three platoons, each with four recon squads. The company is 100 percent mobile. Each squad contains two recon teams.

The NBC reconnaissance company is normally assigned as a separate company of the chemical brigade, but may be attached to a chemical battalion. The company's platoons can conduct NBC reconnaissance, surveys, surveillance, sampling, and limited conventional reconnaissance missions throughout the corps area of operations. Recon squads may also locate potential decon sites. [FM 3-19](#), *NBC Reconnaissance*, provides detailed information concerning NBC reconnaissance operations.

## **Chemical Company (Smoke/Decontamination/Reconnaissance)**

This company provides equipment decon, NBC reconnaissance, large-area smoke, and chemical staff support to armored cavalry regiments (ACR). The company consists of a chemical staff section, a company headquarters, one NBC recon platoon, and one smoke/decon platoon. The company is 100 percent mobile.

The company headquarters has a headquarters section and a maintenance section. The NBC reconnaissance platoon is organized with a platoon headquarters and three reconnaissance squads, each with two recon teams. The smoke/decon platoon is organized with a platoon headquarters, two smoke/decon squads, and a support squad. The smoke/decon platoon is equipped with M1059 mechanized smoke vehicles and M17 LDS. The M1059 is in the smoke/decon squads, and the M17 LDS is in the support squad.

The smoke/decon platoon performs missions similar to the platoons of the smoke/decon company with the same considerations for planning. During offensive operations or operations forward in the covering force area or main battle area, thorough decon operations will probably not be conducted; however, assets may be required to augment operational decon operations. Recon assets, operating forward, locate uncontaminated avenues of approach and contaminated areas that need to be reported to and avoided by follow-on forces.

## **Heavy Division Chemical Company**

The heavy division chemical company provides equipment decon, NBC reconnaissance, large-area smoke, and chemical staff support to armored and mechanized infantry (heavy) divisions. The company is organized

with a division chemical section, an NBC center, a company headquarters, four decon platoons, a mechanized smoke platoon, and an NBC reconnaissance platoon. The company is 100 percent mobile.

The division chemical officer has operational control (OPCON) of the company and advises the division commander on NBC defense procedures and on the employment of chemical unit assets. The specific responsibilities and functions of the division chemical section are discussed later in this chapter.

The company headquarters contains a headquarters section and a maintenance section. Each decon platoon is organized with a platoon headquarters and three decon squads. The smoke platoon is comprised of a platoon headquarters, two smoke squads, and a support squad. The reconnaissance platoon is organized with a platoon headquarters and three reconnaissance squads, each with two recon teams.

The company must be organized to employ its platoons to permit rapid response to changing situations based on the tactical scheme of maneuver and METT-T.

The decon platoons may conduct thorough decon operations in the brigade and division rear area or they may support operational decon efforts forward of the brigade rear boundary. Decon platoons may be required to operate away from the company headquarters for extended periods of time. It is essential that communications, administration, and logistics be planned in detail to maximize support.

The mechanized smoke platoon supports maneuver forces in the forward combat area. The platoon is equipped with M1059 mechanized smoke vehicles and can provide a smoke haze 600 - 1,200 meters in width. If the division is being supported by a mechanized smoke company, the divisional smoke platoon may be placed under the control of the smoke company.

The NBC recon platoon primarily supports efforts for contamination avoidance within the division. The platoon conducts NBC reconnaissance, surveys, surveillance, sampling, and limited conventional reconnaissance missions. The platoon functions are similar to those of platoons in the NBC reconnaissance company.

## **Chemical Company (Airborne/Air Assault)**

The chemical company (airborne/air assault) provides equipment decon, large-area smoke, and chemical staff support to the airborne and air assault divisions. The company is organized with a division chemical section, an NBC center, a company headquarters, and three smoke/decon platoons. The company is 100 percent mobile.

The division chemical officer has operational control (OPCON) of the company and advises the division commander on NBC defense procedures and on the employment of chemical unit assets. The specific responsibilities and functions of the division chemical section are discussed later in this chapter.

The company headquarters contains a headquarters section and a maintenance section. The smoke/decon platoons contain a platoon headquarters, two smoke/decon squads, and a support squad.

Each platoon can provide equipment decon and large-area smoke generation support; however, the platoons cannot perform these missions simultaneously. Platoons cannot immediately switch from one mission to the other and must plan changes to mission configuration in detail.

A platoon can provide smoke haze from 550 to 1,400 meters in width. When the platoon is configured for decon support it can establish two operational decon sites or one detailed equipment decon (DED) station.

## **GARRISON CONTROL OF DIVISION CHEMICAL COMPANIES**

While the division chemical company is a separate divisional company, divisions may chose to attach the company to a subordinate command. Such attachments provide the company additional administrative and logistical resources and support while in garrison. Positioning of the company is the prerogative of the division commander. In deciding where to place the company, the commander should consider that the chemical company is a combat support organization and attachment to a combat support organization would greatly facilitate garrison planning and preparation for battlefield operations. The division engineer, field artillery, aviation, and air defense battalion/brigades operate on similar concepts, albeit on different scales, and share many like pieces of equipment. An administrative/logistical relationship that exists both in garrison and the field is preferred over one that is only shared in garrison. Wherever the chemical company is attached in garrison, the division chemical officer must remain involved in the



training, readiness, and employment of the company as well as the assignment and professional development of company officers and NCOs. As the senior Chemical Corps representative in the division, the division chemical officer brings the experience and knowledge that no other officer has in chemical unit operations.

## **CHEMICAL SERVICE ORGANIZATIONS**

Chemical service organizations provide NBC reconnaissance, decon, and staff support to units where these capabilities do not exist or are inadequate. These units are normally assigned or attached to separate brigades, corps, theater army area commands, and theater army units to provide NBC support across a wide range of capabilities. The chemical service organizations are 100 percent mobile using organic vehicles.

Chemical service organizations depend on the supported unit for administrative and logistical support. All of these units are 100-percent air mobile.

### **Chemical Team FA (Decontamination)**

The FA team provides equipment decon support for installations located behind the division rear boundary or to separate brigades. The team is organized with a headquarters section and three decon squads. The squads can operate one detailed equipment decon station collectively or three operational decon sites separately.

### **Chemical Team JA (NBC Element)**

The JA team provides NBC staff support to augment separate brigades, corps, theater defense brigades, theater armies, and unified commands. It is organized to provide staffing for one 12-hour shift. Responsibilities and functions will normally include operating the NBC warning and reporting system (NBCWRS) and monitoring the status of the command's NBC defense procedures and chemical assets. However, the team may also be responsible for coordinating specific actions dependent on the level of command.

### **Chemical Team JB (NBC Element)**

The mission of the JB team is identical with that of the JA team. The

JB team is organized to provide two 12-hour shifts. The basis of allocation is one per area support group, TAACOM, and selected separate brigades.

### **Chemical Team LA (Reconnaissance)**

The mission of the LA team is to provide NBC reconnaissance support to separate brigades and theater defense brigades. It collects, examines, and identifies NBC contamination, but has limited capability to evaluate data.

### **Chemical Team LB (Reconnaissance)(Special Forces)**

The mission of the LB team is to provide NBC reconnaissance support to Special Forces (SF) units. This support will be in the form of technical expertise about NBC systems and employment tactics, techniques, and procedures. Each of these airborne qualified special chemical reconnaissance teams is assigned to an SF Group.

The special chemical reconnaissance team is employed in one of three modes--unilaterally in a permissive environment; as an augmentation for a Special Forces Operational Detachment-Alpha (SFODA), or as trainers for SFODAs deploying into denied areas. The special chemical reconnaissance team receives additional chemical reconnaissance and SF-related training and is familiar with SF-unique procedures. The team is uniquely suited for rapid world-wide deployment. See [FM 3-18](#), *Special Forces NBC Reconnaissance (LB) Team*.

## **CHEMICAL STAFFS**

Chemical staffs focus on assisting and advising the commander. The chemical staff contributes timely decision making and supervises the execution of decisions. Chemical staff sections at corps, division, and separate combat brigades/armored cavalry regiments are organized as part of the commander's special staff. These sections are not an integral part of a coordinating staff section; however, areas of common interest and habitual association exist. In these areas of mutual interest, the chemical section receives guidance, direction, and coordination of actions from the coordinating staff. All chemical staffs must frequently work together to monitor, improve, and sustain NBC training, unit readiness and standing operating procedures (SOPs).

Chemical staffs also plan and coordinate the employment of supporting chemical units.

## **THEATER ARMY**

The theater army is normally the Army service component in a unified command. The theater army has both operational and support responsibilities. Its exact tasks are assigned by the theater commander-in-chief (CINC) and may have exclusively operational missions, solely logistical missions, or a combination of both. The chemical staff is a special staff section with no fixed organizational structure.

## **CORPS**

The corps headquarters is supported by a chemical staff section, augmented by a JA Team NBC element (NBCE) (see [Figure 1-1](#)). [Appendix C](#) presents the duties and responsibilities of chemical personnel in the corps chemical staff section. The corps headquarters has the following positions--

- The corps chemical Corps chemical staff officer (COL 74A00).
- Assistant corps chemical officer (LTC 74A00).
- Three chemical staff officers (MAJ 74B00).
- NBC officer (CPT 74B00).
- Senior NBC staff NCO (SGM 54250).
- NBC staff NCO (SFC 54B40).
- Three computer-plotters (SSG 54B30).
- Clerk typist (SPC 71L10).
- Two chemical operations specialists (SPC 54B10).

The corps chemical staff section is normally augmented by a JA Team NBCE that establishes the NBC center (NBCC). The JA Team is comprised of--

- NBC element director (CPT 74A00).
- Operations sergeant. (SFC 54B40).
- Two computer-plotters (SSG 54B30).
- Clerk typist (SPC 71L10).

Primarily, the corps chemical section advises the corps commander and staff concerning NBC matters. In garrison, the chemical staff provides technical assistance to subordinate chemical staffs and units. The chemical staff works closely with the coordinating staff on issues such as:

- Assistant chief of staff, G1 (personnel)--chemical casualties, status of chemical personnel, chemical personnel assignments.
- Assistant chief of staff, G2 (intelligence)--NBC intelligence, enemy NBC capabilities/vulnerabilities, current and projected weather, intent to use NBC weapons.
- Assistant chief of staff, G3 (operations)--NBC defense training, NBC vulnerability, effects on corps operations, employment of chemical units, smoke employment.
- Assistant chief of staff, G4 (logistics)--chemical defense equipment and supplies, maintenance of chemical equipment, transportation of chemical assets.
- Assistant chief of staff, G5 (civil affairs)--host nation decon, recon, and smoke support, locally available industrial decon equipment and suitable equipment for decon operations, training and equipping local nationals for NBC defense.

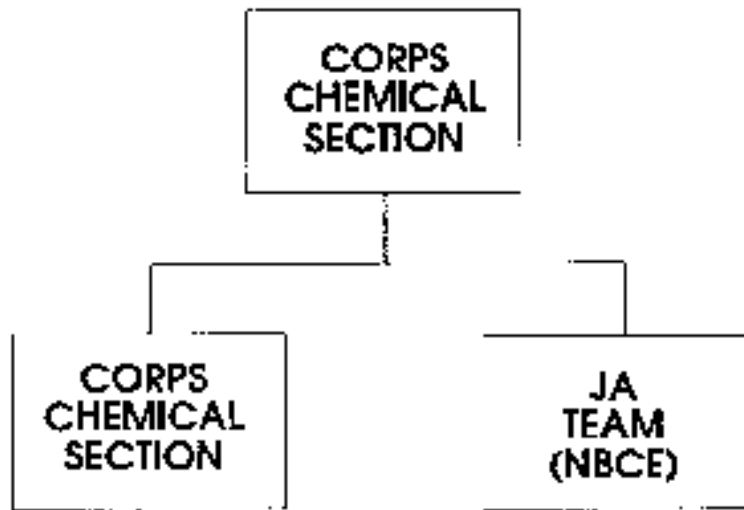

Figure 1-1. Organization of the corps chemical section.

### Field Operations

During field operations, the corps operates three command posts--tactical, (TAC CP) concentrates on the conduct of the corps close operations. The TAC CP main, and rear. The tactical CP consists of one integrated multi-functional cell. The main CP concentrates on the deep battle and plans all future operations. Additionally, the main CP synchronizes the entire corps battle and provides continuity. The main CP has six integrated, multidisciplined cells--headquarters, current operations, plans, CSS, intelligence, and fire support. The cells may be massed at one location or dispersed into four locations. If the main CP is dispersed, the cells are grouped into headquarters/current operations, intelligence, plans/CSS, and fire support. The rear CP conducts rear operations and is normally collocated near the COSCOM CP. The rear CP has three cells--headquarters, operations, and CSS.

The corps chemical staff is split between the TAC and main CPs to provide NBC staff support. Rear CP chemical staff support is provided by organic chemical personnel assigned to the rear tactical operations center (RTOC). [Table 1-1](#) shows the distribution of the corps chemical staff in the CPs.

Table 1-1. Organization of the corps chemical staff for combat.

Duty Position	Command Post/Cell	Shift
Corps chemical staff officer	Main/Current Operations	A/B
Assistant corps chemical officer	Main/Current Operations	A
Chemical staff officer	TAC CP	A
Chemical staff officer	Main/Plans	A
Chemical staff officer	Main/Current Operations	A
NBC officer	Main/Current Operations	B
Senior NBC staff NCO	Main/Current Operations	A
NBC staff NCO	TAC CP	B
Computer-plotter	Main/Current Operations	A
Computer-plotter	Main/Current Operations	B
Computer-plotter	Main/Plans	B
Clerk typist	Main/Current Operations	A
Chemical operations specialist	Main/Current Operations	A
Chemical operations specialist	Main/Current Operations	B
NBC element director	Main/Current Operations	B
Operations sergeant	Main/Current Operations	B
Computer-plotters	Main/Current Operations	B
Computer-plotters	Main/Current Operations	B
Clerk typist	Main/Current Operations	B
Chemical officer (CPT 74A00)*	Rear/Operations	
NBC NCO (SSG 54B30)*	Rear/Operations	

\* Assigned to the RTOC

## Tactical Command Post

The TAC CP is positioned well forward and normally near the division main CP of the main effort division. The primary function of the TAC CP is to control the close operation. The entire CP is organized into one integrated cell controlled by the G3. The primary chemical staff functions of the TAC CP are--

- Assess the status and capability of friendly units to operate in an NBC environment.
- Coordinate chemical support (decon, recon, and smoke) for close operations.
- Provide information on the close operation to the NBCC at the corps main CP.
- Maintain status of supporting chemical assets.
- Maintain liaison with chemical brigade headquarters.
- Process reports of NBC attacks and advise on their impact to the current close operation.

## **Main Command Post**

The primary function of the main CP is to synchronize the overall corps operations, conduct deep operations, and plan future operations. The corps chemical staff officer and much of the corps chemical section staff operate from the main CP. While most of the chemical staff operates the NBC center (NBCC) in the current operations cell, there are members of the chemical staff working in other cells in the main CP.

**Current Operations Cell.** The NBCC is located within the current operations cell. The primary functions of the NBCC are--

- Advising commander and staff on NBC defense matters.
- Monitoring subordinate chemical unit status.
- Operating the NBCWRS for the corps.
- Conducting vulnerability analysis of friendly forces.
- Assisting the G2 in identifying NBC-related intelligence requirements.

- Assisting the G2 in interpreting NBC-related intelligence.

The NBCC's routine operations include calculating, collating, and processing NBCWRS information. The NBCC collects all reported data and evaluates, plots, and places it in appropriate NBC report formats. The NBCC evaluates NBC data received from subordinate units; it plots this data on NBC situation maps or overlays. These maps and/or overlays show the actual areas affected by the contamination at a selected time for a given area of interest. The maps or overlays also show predicted downwind hazard areas. NBCC personnel recompute and adjust the prediction several times daily based on changes, the decay rate, additional contamination, and/or the tactical situation.

The NBCC provides information on enemy NBC activities. NBCC personnel prepare an overlay showing the locations, times, number, and extent of enemy NBC attacks. This overlay provides higher commands data on number of strikes reported and nuclear yields employed. It also gives a brief assessment of the significance of these strikes. The NBCC uses the NBC reports described in [FM 3-3](#) and [FM 3-3-1](#) to distribute and exchange NBC hazard information. It also ensures that the information is provided to the chemical section.

It evaluates the impact of NBC contamination on tactical operations. The evaluation may include information on the degree of contamination at selected points or areas, effects of contamination on tactical units, and protection required by troops operating in designated contaminated areas. The NBCC must be prepared to recommend the length of time troops can safely operate in radiologically contaminated areas. In coordination with the surgeons's staff, it also must be prepared to make recommendations about the psychological aspects of prolonged operations in an NBC environment in MOPP gear.

Once the effects of contamination on tactical operations has been assessed, the NBCC recommends the type and quantity of supplies and equipment required to support decon operations. It balances these recommendations with information received from the COSCOM chemical staff section & G4 on available NBC supplies & equipment.

The NBCC also predicts the casualty-producing effects of enemy nuclear bursts on friendly forces. The NBCC prepares fallout predictions from collected NBC intelligence. It distributes these as prescribed in the SOP or as directed by the G2.



The NBCC receives, processes, and plots radiological monitoring reports from subordinate units. When radiological monitoring information concerning the corps' area of interest is inadequate, the NBCC, in cooperation with appropriate TOC elements, recommends locations for conducting surveys. The NBCC may coordinate and control a corps-level radiological survey if transportation, communications, and personnel assets are available.

If a radiological survey is controlled directly by the corps headquarters, the NBCC acts as the control party. The NBCC briefs the survey parties and designates the areas to be surveyed. Briefing includes the type, the amount, the frequency, and the means of reporting. For detailed procedures pertaining to radiological monitoring and surveys, see [FM 3-3-1](#).

**Plans/CSS Cell.** The function of the plans cell is to plan future operations and continuously develop feasible options for future execution. The CSS cell provides CSS representation in the main CP to the plans cell to ensure support and integration of CSS into plans. Two members of the chemical staff operate in the plans/CSS cell to ensure chemical support and integration of NBC defense into future plans. They prepare the NBC estimate and integrate NBC defense and smoke operations into future operations. They work closely with the corps chemical officer, corps chemical staff officer, and chemical brigade S3. The chemical plans personnel prepare the NBC and smoke annexes.

## Rear Command Post

The rear CP conducts rear area operations. The primary function of this CP is to perform terrain management, plan and control rear security operations, sustain the corps fight, and plan and control corps administrative movements. The rear CP is comprised of three cells-- headquarters, operations, and CSS. The rear CP is augmented by a reserve component augmentation TOE (LTOE 52403 L000), an rear tactical operations center (RTOC). The RTOC has its own chemical staff.

The chemical staff is located in the operations cell. Its primary functions are--

- Assisting in terrain management by maintaining a detailed and current list of all known contaminated areas in the corps area.

- Assisting subordinate chemical units in coordinating CSS support.
- Coordinating chemical support for units in the rear area.
- Monitoring the status of corps chemical units.
- Assisting in the synchronization of NBC support in the corps rear.
- Exchanging information with the NBCC.
- Coordinating host nation NBC support with the G5 in the CSS cell.
- Receiving and processing NBC reports from rear area units.
- Act as the corps NBCC when the main CP is moving or has been destroyed.

## **CORPS SUPPORT COMMAND**

The COSCOM has a chemical staff of eight personnel. The staff functions as part of the security, operations, training, and intelligence (SOTI) section with the primary mission of providing NBC staff support. The COSCOM chemical staff section must work closely with the RTOC, the chemical brigade headquarters, and the corps chemical staff.

The COSCOM chemical staff section serves as an intermediate NBC warning and reporting center. It collects data from COSCOM units and passes this information to the corps NBCC. In turn, the corps NBCC evaluates and processes the data. The NBCC then sends the data back to the COSCOM chemical staff section (and RAOC) for distribution to subordinate COSCOM units.

The COSCOM chemical staff assists in planning for the pre-positioning of NBC defense equipment and supplies to support corps decon and smoke operations. In conjunction with this, the staff assesses the operational readiness of NBC defense equipment throughout the COSCOM. The COSCOM chemical staff section makes recommendations to the SOTI officer and the COSCOM commander on contamination avoidance and individual and collective protection.

If a corps chemical company is attached to the COSCOM, the COSCOM chemical officer may have OPCON of it. At a minimum the COSCOM chemical

staff section would have the responsibility of advising the SOTI officer on how supporting chemical units should be employed to support rear operations.

Chemical staffing elsewhere in the COSCOM is limited. The corps support group headquarters has a chemical corps captain and a chemical operations NCO (MSG) for the same purposes.

## **DIVISION**

For divisions with organic chemical companies, the division chemical staff section is assigned to the chemical company. For divisions without an organic chemical company (light infantry), the division chemical staff is assigned to the division headquarters. In either case, the functions are identical. The division chemical staff is organized in two sections, the division chemical section and the NBC center (see [Figure 1-2](#)).

[Appendix C](#) presents the duties and responsibilities of chemical personnel in the division chemical staff section. The division chemical staff section has the following positions--

### Division chemical section--

- Division chemical officer (LTC 74B00).
- Tactical chemical operations officer (MAJ 741300).
- NBC operations NCO (SGM 54Z50).
- NBC staff NCO (SFC 54B40).
- Clerk typist (SPC 71L10).

### NBC Center--

- Chemical officer (CPT 74B00).
- NBC officer (CPT 74B00).

- Chemical operations NCO (MSG 54B50).
- NBC staff NCO (SFC 54B40).
- Operations sergeant (SFC 54B40).
- Computer-plotter (SSG 54B30).
- NBC NCO (SSG 54B30).
- Clerk typist (SPC 71 L10).

The division chemical staff operates similar to the corps chemical staff. The main distinction between the division and corps chemical staff is the scope of the operations. While corps staff focuses on the operational level of war, the division staff is concerned with the tactical level of war.

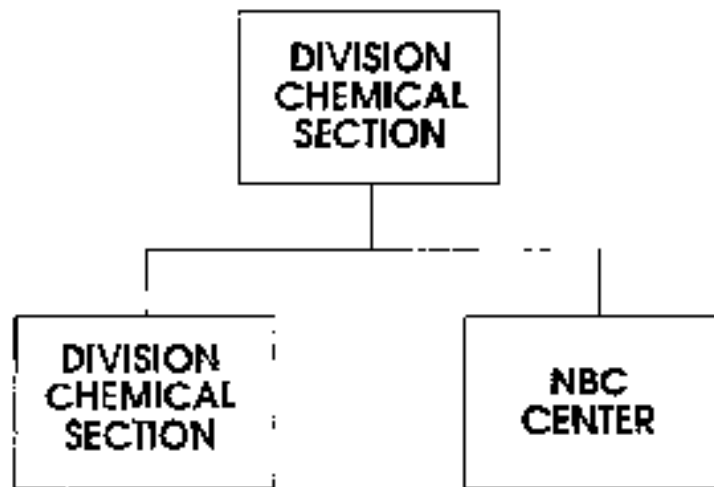

Figure 1-2. Organization of the division chemical staff section.

The division establishes main, tactical, and rear CPs. Additionally, the division may establish an alternate CP. The division chemical staff will position chemical personnel in the main and tactical CPs. The alternate CP may be augmented by personnel from the division chemical staff. The division artillery (DIVARTY) headquarters, which contains a small chemical staff, is normally designated as the alternate CP. An NBC NCO (SFC) from either the division chemical section or NBCC may be

sent to the alternate CP for liaison purposes. The rear CP is normally collocated with the division support command (DISCOM) CP. The DISCOM chemical staff provides chemical staff support to the rear CP as necessary. If the rear CP does not collocate with the DISCOM, personnel from the division chemical staff may need to be sent to the rear CP.

The division chemical staff is split between the TAC and main CPs to provide NBC staff support. NBC staff support is provided to the rear CP by chemical personnel assigned to the DISCOM. [Table 1-2](#) shows the distribution of the division chemical staff in the CPs.

**Table 1-2. Organization of the division chemical staff for combat.**

Duty Position	Command Post/Cell	Shift
Division chemical staff officer	Main/NBCC	A/B
Tactical chemical operations officer	TAC/M/CM	A/B
Senior NBC operations NCO	Main/NBCC	A
NBC staff NCO	TAC/M/CM	A
Clerk typist	Main/NBCC	A
Chemical officer	Main/NBCC	A
NBC officer	Main/NBCC	B
Chemical operations NCO	Main/NBCC	B
NBC staff NCO	Main/NBCC	A
Operations NCO	Main/NBCC	B
Computer-plotter	Main/NBCC	A
NBC NCO	TAC/M/CM	B
Clerk typist	Main/NBCC	B

**TAC CP.** The TAC CP contains only those elements and information that directly contribute to the conduct of the current close operation. The TAC CP is comprised of four elements--G-2, G-3, G-3 mobility /countermobility (M/CM), and fire support element (FSE). The chemical staff works in the G-3 M/CM element ([Figure 1-3](#)). The chemical staff coordinates and integrates chemical operations in support of the close

operation.

The primary functions of the TAC CP chemical staff--

- Advise the division commander and G3 on the impact of enemy NBC attacks and friendly operations in an NBC environment.
- Coordinate chemical support (decon, recon, and smoke) for close operations.
- Maintain the status of contaminated areas in the division area.
- Maintain status of supporting chemical assets.
- Maintain liaison with subordinate/supporting chemical unit headquarters.
- Provide information on the close operation to the NBCC at the division main CP.

The TAC CP chemical section does not normally establish priorities or allocate resources for chemical support, but may be required by the situation to do so.

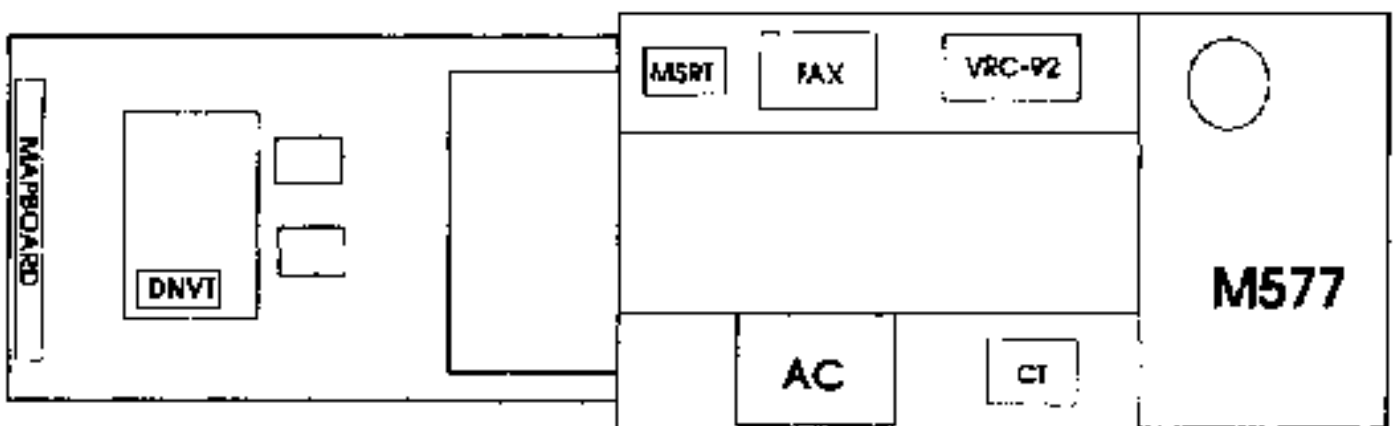

Figure 1-3. Heavy division G3 M/CM M577 for the TAC CP.

**Main CP.** The main CP has three functional cells--command, G3, and G2. The division chemical staff constitutes the NBCC in the G3 cell ([Figure 1-4](#)). The primary functions of the main CP is to--

- Recommend allocation of resources to the deep, close, and rear operations.
- Establish priorities for deep, close, and rear operations.
- Plan future operations.
- Coordinate, integrate, synchronize available assets to support current and future operations.

The primary functions of the NBCC are to--

- Coordinate, integrate, and synchronize the employment of all organic and supporting chemical units to support the division fight.
- Recommend allocation chemical resources and establish priorities for chemical support to support the division's deep, close, and rear operations.
- Operate the division's NBCWRS.

At the division level chemical personnel normally work with the G2 and G3 cells. The NBCC maintains close coordination and liaison with these cells. Additionally, the division chemical officer provides assistance to the planning cell to prepare the NBC estimates and the NBC support plans and annexes.

The NBCC maintains the status of all subordinate/supporting chemical units as well as critical NBC logistic items. The NBCC also maintains close liaison with supporting and subordinate chemical units.

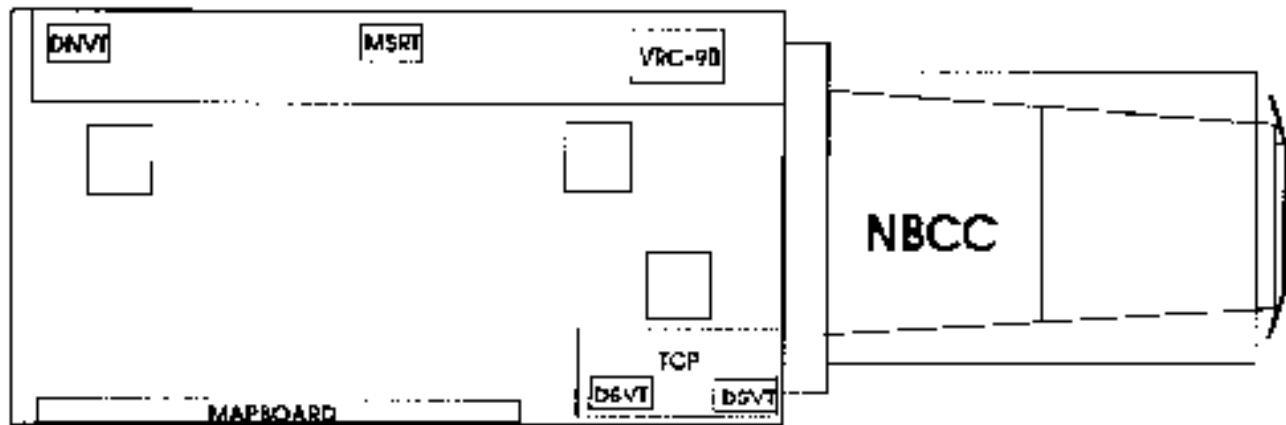

Figure 1-4. Heavy division NBCC vehicle.

## BRIGADE

The brigade chemical section advises the brigade commander on all NBC matters. The section coordinates with the other staff sections as necessary. The section also operates an NBC sub-collection center (NBSCC). The NBSCC collects, consolidates, and distributes all NBC reports from subordinate, adjacent, and higher organizations. The organization of the brigade chemical section varies with the type of brigade. Normally, the brigade chemical section operates out of the main CP. The brigade chemical officer is a member of both the current operations and plans sections. They work in close coordination with the intelligence and fire support sections. The brigade's army airspace command and control (A<sup>2</sup>C<sup>2</sup>) section requires information concerning chemical hazard areas and planned and current smoke operations. The brigade chemical staff also will coordinate and assist the operations support section on NBC logistics matters.

During garrison operations, the chemical staff section provides training to subordinate chemical personnel and advises the brigade commander on NBC training requirements. The section also conducts training visits and evaluations.

The chemical staff section is responsible for developing the NBC support plan for the brigade. The NBC support plan may be included in the basic OPLAN/OPORD or as an annex to the OPLAN/OPORD. The brigade chemical section prepares the NBC support plan in conjunction with the basic plan/order. Formats for an NBC support plan are included in [Appendix F](#). The role of the chemical staff officer in the planning process is described in detail in [Appendix D](#).



## Separate Combat Brigades

The separate brigade's chemical section is staffed with more personnel than a divisional brigade. The duties and responsibilities are very similar to those of the division chemical staff section. [Figure 1-5](#) shows an organizational diagram of the separate brigade chemical section.

## Armored Cavalry Regiments

The chemical section in the armored cavalry regiments is part of the regiment's chemical company. The section is staffed with more personnel than a maneuver brigade and functions like a division chemical section.

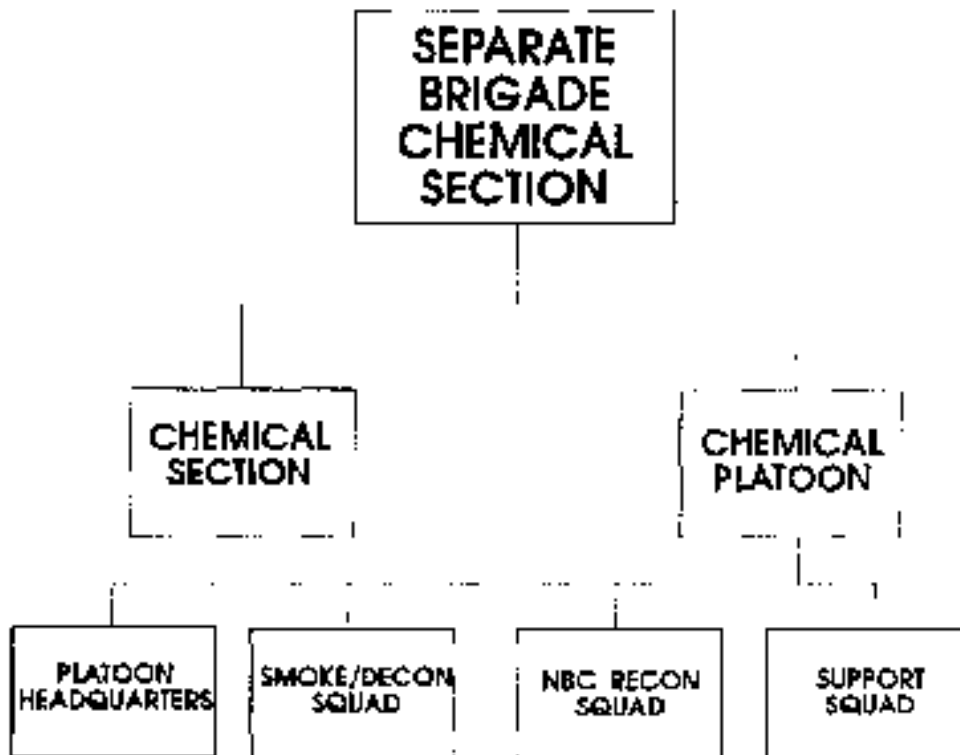

Figure 1-5. Organization of the separate brigade chemical section.

## **BATTALION**

The battalion chemical personnel functioning similar manner to the chemical personnel of the brigade section. The only real difference is their scope. The battalion chemical officer functions as the battalion commander's primary advisor on NBC matters and as an assistant S3.

Battalion chemical personnel also include the battalion chemical NCO (SSG) and decon specialist (SPC).

The battalion chemical officer participates in the planning effort and prepares a chemical support plan. The chemical support plan is typically included in the basic OPLAN/OPORD.

In garrison, the battalion chemical personnel assist in training and conduct inspections of subordinate units to ensure all NBC defense equipment and supplies are being maintained.

[RDL](#)[Table of](#)[Document](#)[Download](#)[Homepage](#) [Contents](#) [Information](#) [Instructions](#)

---

## CHAPTER TWO

# CHEMICAL UNIT EMPLOYMENT CONCEPTS

Chemical units are employed to enhance combat power. Combat power is the ability to fight and is achieved by combining maneuver, firepower, protection, and leadership. Through proper employment, chemical units are significant combat multipliers. Chemical units increase combat capabilities on the battlefield by reducing the effects of NBC weapons and making enemy target acquisition less effective. Chemical units are used at brigade/regiment, division, corps, and echelons above corps. Chemical units provide decon, large area smoke, NBC reconnaissance, and staff support.

## UNIT OPERATIONS

NBC operations on the battlefield will create tremendous challenges. Unit NBC defense training, chemical staff planning, and proper and effective use of chemical units and staff personnel will greatly reduce the effects of NBC weapons.

## GENERAL PRINCIPLES

### Task-organize chemical units to requirements

Mission requirements drive size and composition of chemical units. A mix of different units (smoke, decon, and NBC recon) is often necessary to achieve the proper balance of capabilities. This mix can change as the operation progresses.

### Give priority to the main effort

There are never enough chemical units to handle all tasks. Chemical

units are spread evenly across the battlefield, but are concentrated with the main effort to ensure success. This requires accepting risk elsewhere.

### **Integrate chemical units with maneuver and fire**

The scheme of maneuver governs the chemical support plan. Smoke and NBC recon elements enhance the effectiveness of fire and maneuver. Chemical units will operate well forward in the combat zone and will require the protection offered by fire and maneuver.

### **Ensure current chemical support operations promote future force operations**

Chemical units and staffs must anticipate future missions and reposition their units, if necessary, while accomplishing the current mission. The positioning of decon sites should not interfere with future operations.

### **Do not hold smoke and NBC recon units in reserve**

Chemical units, especially smoke and NBC recon, do not remain with forces that are not in the fight. They remain out of action only long enough to refit after a major action.

### **Build a logistically sustainable force**

Resources are always limited. Chemical units cannot sustain themselves and require support from other organizations. Chemical unit sustainment and the supporting logistics structure must be planned in detail. Logistic limitations may restrict the size of the supporting chemical unit.

### **Maintain effective battle command**

Effective plans use all available chemical unit headquarters, align them with maneuver boundaries, and hand off operations smoothly between them.

### **Use all local resources**

Chemical units, particularly decon units, need to use local resources. Host nation support should always be considered and used when available. Use of host nation chemical support in the rear areas can release more chemical units forward to the combat zone.

## **COMMAND AND CONTROL HEADQUARTERS**

Chemical unit control headquarters (chemical brigade HHC and chemical battalion HHD) are employed to provide command, control, and coordination for subordinate chemical units. These organizations also provide certain logistical support and facilitate the coordination of logistical support for their subordinate units. This allows the supported unit's chemical staff to concentrate on NBC defense planning and execution rather than logistical support for supporting chemical units.

The chemical brigade HHC can control up to six chemical battalions and is normally allocated to a corps. In contingency operations it is possible that the chemical brigade HHC could be allocated to the theater army (Army component commander) commander to control all chemical assets in the theater.

The chemical battalion HHD can control up to five chemical companies and detachments. Chemical battalion HHDs are allocated to a corps based on the number of chemical companies assigned. As seen in Operation Desert Shield/Storm, it is possible that the chemical battalion HHD will be the senior chemical command and control element in a corps.

Having a chemical battalion HHD instead of a chemical brigade HHC in support of a corps means --

- The corps chemical staff assumes a greater role in planning and coordinating chemical unit operations, to include the coordination of logistical support to the chemical units.
- Chemical battalion HHD communications assets are not as robust as the chemical brigade's. This limits the responsiveness and flexibility of supporting chemical units.

## **SMOKE UNITS**

## Smoke Operations

The mission of smoke units is to generate large-area smoke screens. These smoke screens decrease friendly force vulnerability and/or degrade threat force's command, control, communication, and intelligence capabilities from the forward to the rear areas of the battlefield. Smoke is used on the battlefield to--

- Obscure.
  
- Screen.
  
- Protect.
  
- Mark.

Smoke support provided by smoke generator units should be integrated with other available smoke-producing assets. Such assets include artillery- and mortar-delivered smoke projectiles, smoke pots, and vehicle self-protection smoke systems. These assets should be integrated with the preceding employment concepts to achieve the most effective smoke support.

For further information concerning smoke operations, see [FM 3-50](#), *Smoke Operations*.

## Smoke Unit Employment

Both motorized and mechanized smoke generator units can produce either fixed-area or mobile smoke screens as required. Mechanized smoke units are best employed supporting maneuver forces, while motorized smoke units normally support units not engaged in close combat. Motorized smoke units in support of motorized and light units do operate well forward. However, these are not strict rules. Smoke units will be employed wherever needed to support a maneuver force. This does not mean they will operate across the FLOT on their own. Smoke units should never be kept in reserve. Units unable to use their supporting smoke units for whatever reasons should return control of the smoke unit to their higher headquarters.

Before beginning the planning process, the smoke unit leader needs the following items of information from the supported unit--

- Commanders intent.
- Location and size of the area to be screened.
- The time smoke coverage is required.
- Duration of smoke coverage.
- Visibility desired within the screen.
- Operational activities of the supported unit.

Using this information, the smoke unit leader issues a warning order to his unit. He initiates a recon of the operational area in as much detail as time and the situation permits. Depending on coordination required, the entire planning process can take a few minutes or a few hours.

The objective or selected area or areas to be concealed are located during the recon. This is necessary to determine weather and terrain information. Based on this information and the supported unit's visibility requirements, the spacing between smoke generator systems and minimum distance from these systems to the area to be concealed can be calculated. This calculated distance is a guide only. Actual locations of individual smoke generator systems are determined by using METT-T.

All smoke generator units depend on the wind to carry the smoke over the area to be concealed. Alternate positions for smoke generator systems must be planned to provide the required coverage for any wind direction. Obviously, it is not possible to use these alternate positions for every operation because of untrafficable terrain, enemy troop locations, and other factors. In such cases, plans must include the use of other smoke sources, such as smoke pots or artillery- or mortar-delivered smoke projectiles.

During fixed-area screening operations, units use primary and alternate smoke positions. [Figure 2-1](#) illustrates how a motorized smoke platoon plans coverage of a brigade support area (BSA). The smoke platoon

occupies the primary smoke line. The alternate smoke lines provide overall coverage in the event that wind shifts.

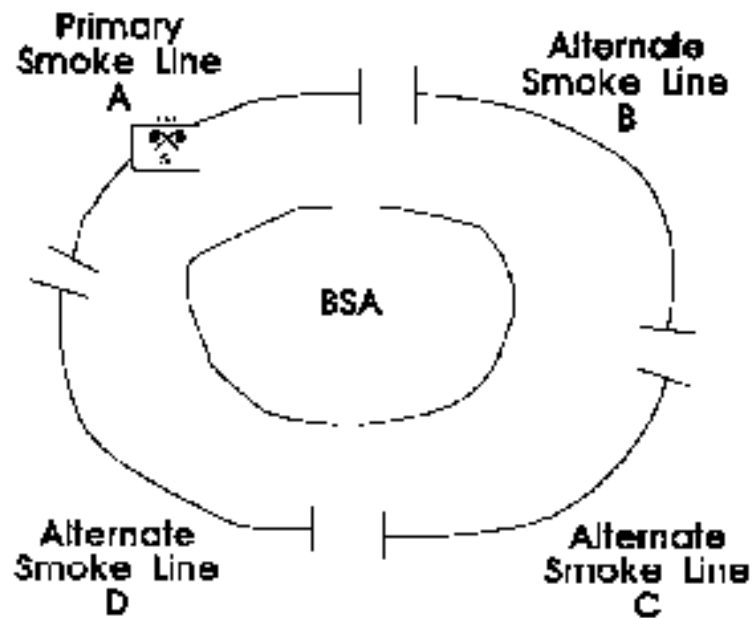

Figure 2-1. Smoke platoon placement to cover a brigade support area.

Mobile smoke operations use primary and alternate positions for each smoke source. [Figure 2-2](#) illustrates how a corps mechanized smoke company plans coverage of a brigade task force assaulting an enemy strongpoint. In this case, because of the threat, alternate positions cannot be planned to ensure coverage of the required areas for any wind direction.



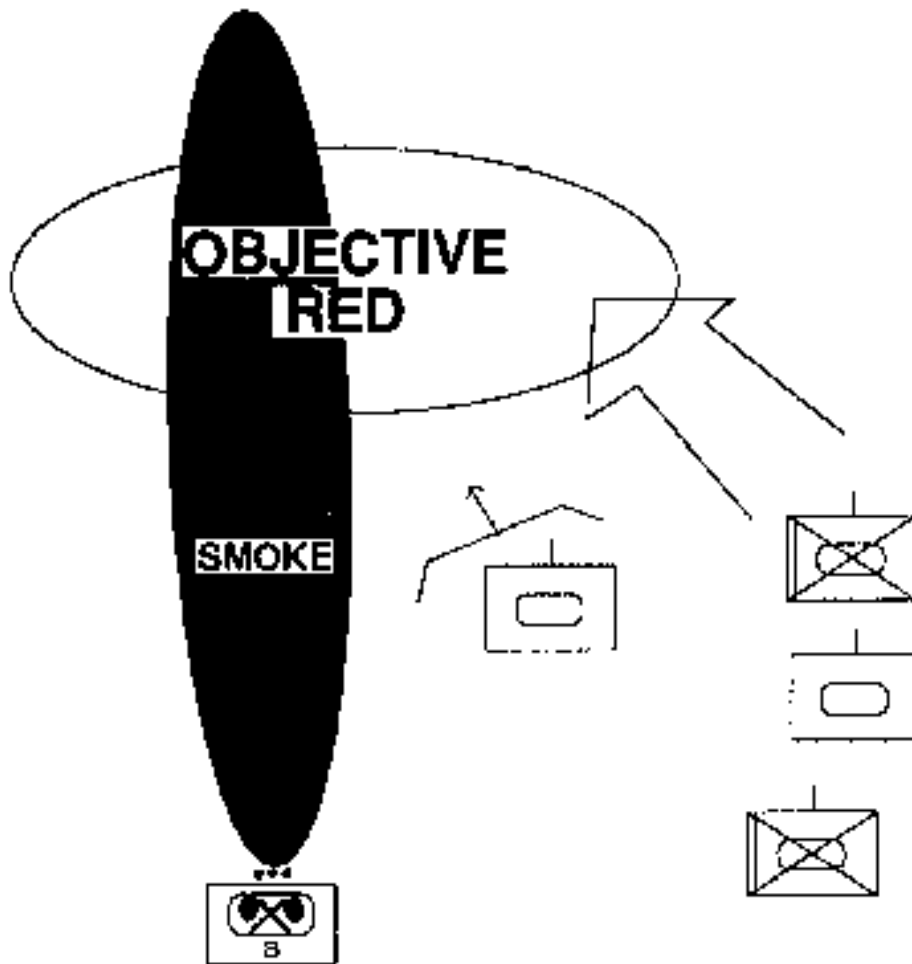

Figure 2-2. Mechanized smoke company in support of an armored battalion/task force.

## DECON UNITS

### Decon Operations

There are three types of decon: immediate, operational, and thorough. Decon units provide operational & thorough decon support. Decon operations are planned and executed following these principles. Decontaminate--

- As soon as possible.
- Only what is necessary.
- As far forward as possible.
- By priority.

**Operational Decon.** The objective of operational decon is to remove just enough of the contamination to allow soldiers to sustain operations. Operational decon should begin at the earliest opportunity. Rapid decon reduces the potential for delayed injuries and casualties, thus enhancing unit effectiveness. Operational decon uses two decon techniques--MOPP-gear exchange and vehicle washdown. It requires support from the battalion-level power-driven decon equipment (PDDE) crew or from a decon squad or platoon.

An unsupported vehicle washdown occurs when the contaminated unit uses its organic equipment to conduct the washdown. A supported vehicle washdown is when the assets from a decon unit are used. A decon unit may support operational decon operations when--

- The contaminated unit's decon equipment and resources are unable to process their contaminated vehicles in a timely manner.
- If the mission of the maneuver unit is critical and limited by time, the operational supported concept will speed the decon process.
- The contaminated unit does not have the equipment or their equipment is not serviceable.

**Thorough Decon.** Thorough decon is the process of reducing the contamination hazard to a negligible risk. Thorough decon uses two techniques - detailed troop decon (DTD) and detailed equipment decon (DED). DTD is the process of decontaminating individual soldiers. DED is the process of removing or neutralizing contamination on the interior and exterior surfaces of unit equipment. A contaminated unit undergoing DED and DTD can allow MOPP reductions for extended periods. Thorough decon operations are conducted by decon units with support from the contaminated unit. The contaminated unit will set-up and run the DTD line with guidance (if needed) from the supporting decon unit.

Decon units can conduct thorough decon operations under three different situations: after combat operations, during reconstitution, and during a passage of lines. These three situations present different considerations for command and control, management of supplies, resources and planning of decon operations,

**Thorough decon after combat operations.** A mission capable unit (for

example, a field artillery battery) has been contaminated. The battery is needed for an upcoming high priority mission. However, the contamination does not allow the unit to perform at 100 percent of its capability because of MOPP degradation.

The decision is made to support the contaminated unit with thorough decon to restore its combat power by lowering the contamination to a negligible risk. The decision to support this battery with thorough decon operations, in this situation, probably will be made at division level. The exact setup of the thorough decon site is dependent on METT-T (the friendly and enemy tactical situations, the number of contaminated vehicles and personnel, the number of decon platoons available, and the time available to conduct the decon).

**Thorough decon during reconstitution.** Reconstitution consists of reorganization, assessment and regeneration. Thorough decon operations are conducted during the reorganization and/or regeneration process. Operations that support regeneration of combat power may involve support to units that are contaminated. The contaminated units may not be capable of providing unit personnel to the detailed equipment decon line because of combat losses. To minimize the transfer or spread of contamination, thorough decon will occur before the sustainment activities (that is, manning, supplying, maintaining).

Additional personnel will be provided as needed to man decon lines and operate vehicles to accomplish thorough decon. This decon process will occur forward from the designated assembly area before the contaminated unit goes through the large scale replacement of personnel, equipment, and supplies. Corps- and division-level decon units can provide decon support during reconstitution operations.

**Thorough decon during a passage of lines.** A unit conducting a rearward passage of lines under enemy pressure has encountered contamination during its movement. The principles "decon as far forward as possible" and "decontaminate as soon as possible" apply in this case. The division (or higher) makes the decision to execute operational decon forward to limit the spread of contamination and unit degradation. The operational decon site is established near the end of the passage lane and out of enemy direct fire. See [figure 2-3](#).

Once operational decon operation is completed, the contaminated unit can proceed without spreading contamination. Prior to arrival at the tactical assembly area, the contaminated unit will conduct thorough

decon.

For further information concerning decon operations, see [FM 3-5](#), *NBC Decontamination*.

## Decon Unit Employment

Decon units are employed based on METT-T. By determining the threats capability and ability to employ ground contaminating chemical agents, a threat assessment is made. Depending on the threat assessment, decon units are allocated and positioned. There are two techniques for employing decon units: centralized and decentralized. Under centralized operations, decon units are controlled at the highest levels. Units needing decon support request the support from the controlling headquarters. The controlling headquarters analyzes the request for support. Once the decision is made to provide decon support, a decon unit is given the task of providing the requested support. Under decentralized operations, decon units are positioned around the battlefield based on METT-T. Control of the decon units is passed to subordinate units.

Centralized operations are best used when--

- The NBC threat is vague or unknown.
- There are insufficient decon assets to support each major subordinate command with dedicated assets.
- The controlling commander wants to retain maximum flexibility at his level.

Decentralized operations are best used when--

- There is a well-defined NBC threat.
- The controlling commanders want their subordinates to have maximum flexibility in employing decon assets.
- Time and space prevent the higher headquarters from providing responsive decon support.

- Communications between higher and subordinate units may not allow responsive decon support.

All echelons must conduct some planning and preparation for conducting decon operations. Most decon planning is conducted at the levels that have control of decon units. Decon planning is conducted as part of the overall planning process. The commander should provide guidance on decon to the chemical staff early in the planning process. The commander's guidance should indicate under what circumstances operational or thorough decon operations will be conducted and their priorities for decon support.

For example, "if the maneuver forces become contaminated during the attack, they'll continue to fight dirty until after the objective is secured. We then conduct thorough decon as necessary while preparing for the next operation. Artillery units contaminated during the battle may require operational decon support so that they can sustain operations. Priority of decon support is to artillery, CSS, C2, and maneuver units". From the commander's general guidance concerning decon, the chemical staff officer and the chemical unit commander can begin to develop the decon plan.

The chemical staff will select possible decon sites throughout their area of operations. The selection of the decon sites is based upon the type of decon operation (operational or thorough), terrain, the scheme of maneuver, the threat, the road network, and the availability of water. After the decon sites are selected, link-up points are chosen to support each decon site. It is possible that one decon site may have more than one associated link-up point. The selection of the link-up points requires careful consideration. The decon link-up points must be easily recognizable to all parties.

Since the total decon capability of any unit is limited, the commander must establish a priority of decon support. The priority of support can change from phase to phase during an operation. The chemical staff develops the priority of support by determining the decon technique to be used (operational or thorough), the threat (what units are likely to become contaminated and when), and the likelihood the unit can accomplish decon. To give priority of support to the lead force during the assault phase may not be the best choice since elements of the task force that become contaminated will most likely not stop to accomplish decon until after the assault is completed. The commander should establish a priority of work that specifies the order vehicles are

decontaminated. A priority of work may look like this: Engineer equipment, M1, M2, FIST-V. The priority of work also may vary from phase to phase of the operation.

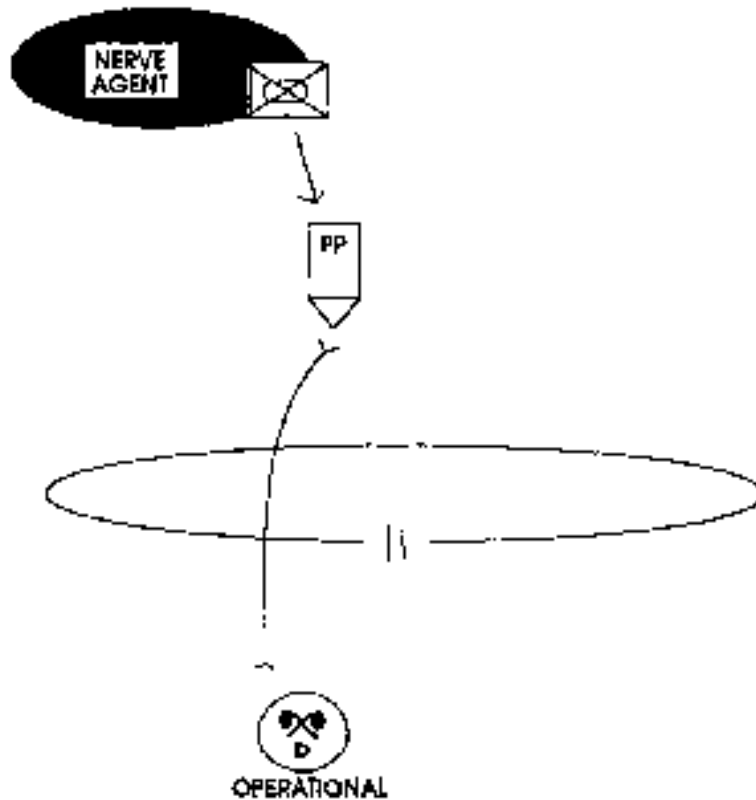

Figure 2-3. Decon operations in support of a passage of lines.

A limiting factor that must be considered when planning any decon operations is the availability of water. [FM 3-5](#) states that 550-gallons of water per vehicle is used during a thorough decon. This is a good planning factor, but it also must be recognized that the amount of water required will vary by type of vehicle. A HWMMV will require less water than an M 1 tank, and a 5,000-gallon fuel tanker will require a lot more water than 550-gallons. The chemical unit/staff must develop a water resupply plan. In a water-rich environment, such as Europe, it is as easy as identifying water sources where the decon platoon can obtain water.

In a water-scarce environment, such as the Middle East, the chemical unit/staff must coordinate a water resupply plan with the G4/S4. A water resupply plan can be as simple as selecting a series of link-up points along the MSR where the decon platoon can link-up with bulk water trucks from a support unit. More complex water resupply plans include linking up with bulk water trucks, caching water throughout the area of operations, coordinating for the movement of water bladders by

aircraft to the decon sites, and the identification of water sources in the unit's area of operation. At times, when the need for decon water is critical, reprioritization of potable water from such sources as laundries and baths may become necessary in order to temporarily meet needs.

The positioning of the decon platoon on the battlefield is an integral part of the decon plan. The initial position of the decon platoon is based on the unit's mission, what unit has the priority of support, and the persistent chemical threat. The chemical staff also must consider the range of the enemy's indirect fire systems and the time the decon platoon requires to move and set up. One technique is the use of phase lines or decision points to trigger the movement of the decon platoon to subsequent decon sites.

The decon plan can be issued in several different formats. One technique for distributing the brigade decon plan is to use an execution matrix that lists the decon site(s), link-up point(s), decon technique, priority of support, and work by phase or event. Decon sites and link-up points must be included on the combat service support graphics.

Deconfliction of proposed decon sites is critical at all levels. Decon sites should support the scheme of maneuver and not interfere with future operations. Subordinate units should clear their proposed decon sites with their higher headquarters to avoid duplication and ensure that the locations do not interfere with future operations.

The decon unit leader should conduct a recon of the proposed decon sites. Since the chemical staff is selecting decon sites by map reconnaissance, the proposed sites may not be suitable. If the proposed sites cannot support decon operations, the decon unit leader should attempt to find another site close to original site. The decon unit leader should never change the location of the decon site without coordination with the supported unit's chemical staff. Link-up points should only be changed as a last resort.

The decon unit leader should attend all the supported unit's rehearsals whenever possible. At a minimum the decon unit leader must have the supported unit's operations and combat service support graphics posted on its map.

The actual decon operation begins once a unit has become contaminated.

The contaminated unit's leaders must assess their situation and accurately report their status to their headquarters. While the unit may not be able to conduct decon during the battle, the decon unit can reposition and begin preparation to process the contaminated unit.

The request for decon support must contain several essential elements of information to assist the chemical staff and the decon unit leader in coordinating the decon operation. These essential elements of information are--

- Designation of the contaminated unit.
- Location of the contaminated unit.
- Time unit became contaminated.
- Earliest possible time the unit can move/begin decon.
- Type of contamination.
- Number of contaminated vehicles by type.
- Number of personnel and casualties contaminated.
- Special requirements (recovery assets, unit decon team, for example.).

Upon learning of a unit being contaminated, the controlling headquarter's chemical staff must begin coordinating the decon operation. The decon unit is given a warning order. Subsequent warning orders provide more detailed information to the decon unit. After receiving the request for decon support, the controlling unit's chemical staff will issue an order to the decon unit. One technique is to have a message format in the SOP that contains all the information necessary to the decon unit to coordinate and execute the mission ([Figure 2-4](#)).

The controlling unit's chemical staff must decide if the decon unit is correctly positioned to support the contaminated unit. This is determined by the locations of the contaminated unit and the decon unit and the impact of moving the contaminated unit to the decon site. If the decon unit is not in position to support the contaminated unit, it



must move as quickly as possible to a decon site that will support the operation. The chemical staff must coordinate the movement of the contaminated unit to the link-up point and the decon site. Depending on the size and type of unit contaminated, the chemical staff may issue a warning order to any elements involved in the water resupply plan.

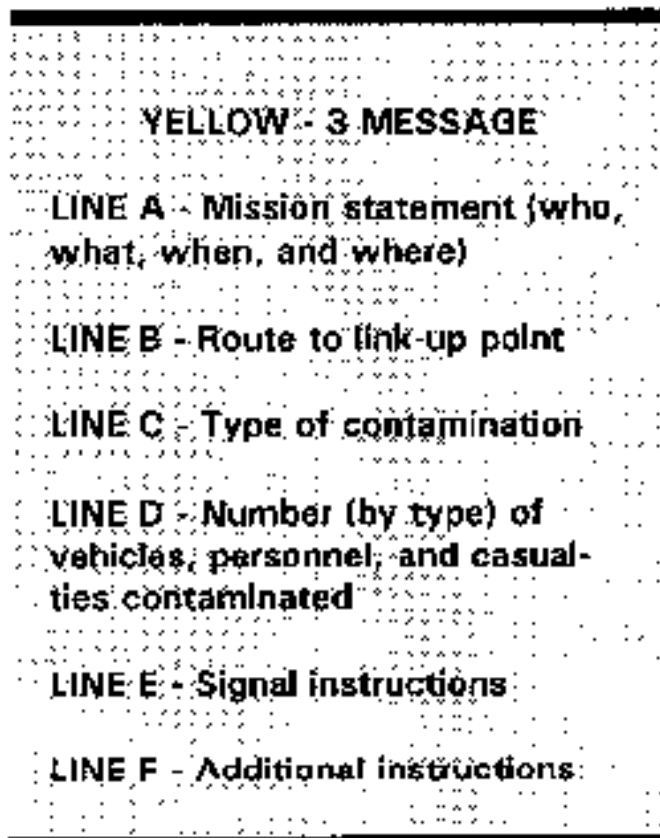

Figure 2-4. Preformatted decon unit mission order.

Once the decon unit is in position and set up, the decon unit's representative moves to the link-up point. The most difficult part of the decon operation is the link-up between the contaminated unit and the decon element. All elements supporting the decon (medical, recovery, logistical, and so forth.) should not be directed to the link-up point unless they are contaminated. Supporting assets must coordinate with the decon unit to be met and led into the decon site. The contaminated unit's higher headquarters must dispatch a command and control cell to the decon site to supervise the decon operation. Movement of units (decon and contaminated) must be coordinated with the G3/S3, engineers, and subordinate headquarters when units will cross boundaries.

After link-up is achieved and all support assets are in position, the actual decon operation can commence. The decon unit's leader, in

conjunction with the supported unit's command and control cell supervise the decon operation. The controlling unit's chemical staff must assert staff supervision during all phases of the decon operation.

## **NBC RECONNAISSANCE UNITS**

### **NBC Reconnaissance Operations**

NBC recon operations support the NBC principle of contamination avoidance. NBC recon provides commanders with freedom of maneuver and minimizes the degradation from operating under NBC conditions. NBC recon operations include search, survey, surveillance, and sampling missions.

NBC recon is a mission undertaken to obtain militarily significant information about the NBC condition of routes, areas, and zones. This information confirms or denies the presence of NBC attacks or hazards with detection and identification equipment. Visual observation or the collection of samples in the specified location or region can also provide this information. NBC surveys are missions conducted to collect detailed information of NBC contamination hazards. The survey determines the type of contamination, the degree (extent/intensity), and the boundaries. NBC surveillance is the systematic observation of an area to provide early warning. Sampling operations provide physical evidence of NBC attacks and technical intelligence concerning the enemy's NBC weapons systems.

### **NBC Reconnaissance Unit Employment**

During offensive operations, NBC recon units will operate throughout the framework of the battlefield. In the forward combat area, NBC recon elements are integrated into the overall recon and surveillance effort. NBC recon units are generally employed to either--

- Confirm or deny contaminated areas.
- Confirm the area is clear of contamination.

Whatever the method of employing NBC recon units, efforts must be focused by the IPB and the supported commander's priority intelligence requirements (PIR) and intelligence requirements (IR).

The capabilities and limitations of the NBC recon systems must be considered when developing the plan. NBC recon platoons can be employed at platoon, section, squad, or team levels. When employed at the team level, it will be paired with an overwatch partner. Both M93 NBCRS (Fox) and M113-equipped units can be used to support maneuver forces. HMMWV-equipped units are best employed at the squad and platoon levels. Because HMMWV-equipped units are less survivable, they are best employed with similar light and motorized maneuver forces or in rear areas. The Fox can rapidly detect and identify chemical contamination. M113-and HMMWV-equipped units do not have the ability to rapidly detect and identify contamination.

**Confirm or deny contaminated areas.** When the NBC IPB identifies possible contaminated areas in the area of operations, NBC recon can be employed to confirm or deny the presence of contamination. Templated contaminated areas that could affect the scheme of maneuver are designated as Named Areas of Interest (NAI). These NAIs are included in the Reconnaissance and Surveillance (R&S) Plan. Supporting NBC recon elements are tasked in the R&S Plan to observe selected NAIs. The NBC recon can observe the designated NAIs through physical recon or by observation. If the NBC recon element conducts a physical recon of the NAI, the supporting unit may have to provide security. Detailed coordination with other recon assets is required to prevent duplication and fratricide.

**Confirm the area is clear of contamination.** NBC recon elements are integrated into the combat formation. They move behind or with the lead maneuver force. If the formation encounters contamination, the NBC recon can deploy to find clear by-pass routes around the contaminated area. The lead maneuver force provides security as the NBC recon elements attempt to find a by-pass route. Once the by-pass route is located, the NBC recon is integrated back into the formation in case there are additional contaminated areas.

In the rear areas NBC recon units are employed to allow the supported commander to retain the freedom of maneuver. NBC recon efforts are again focused by the IPB and the R&S plan. NBC recon elements can be positioned throughout the rear conducting NBC surveillance missions. Main supply routes (MSRs) and other vital routes can be monitored for contamination by periodically patrolling the routes.

During defensive operations, NBC recon elements can be assigned NBC

surveillance missions behind the main defensive positions to observe designated NAIs for NBC activity. Once NBC activity is observed, the NBC recon element can be employed to confirm or deny the presence of chemical agents. If contamination is found, the elements can find clear by-pass routes and mark the contaminated area. This gives commanders the freedom to maneuver behind their main defensive area. NBC recon elements may support to counterattack forces to rapidly find by-pass routes if contamination is encountered.

In the corps and TA rear area NBC recon units will conduct NBC recon operations along MSR and at critical points. They also respond to reports of NBC attacks to determine the type and extent of contamination. Additionally, NBC recon units may be assigned NBC surveillance missions to observe designated areas for NBC attacks. Areas to be occupied by logistics and C2 facilities can be checked for NBC hazards.

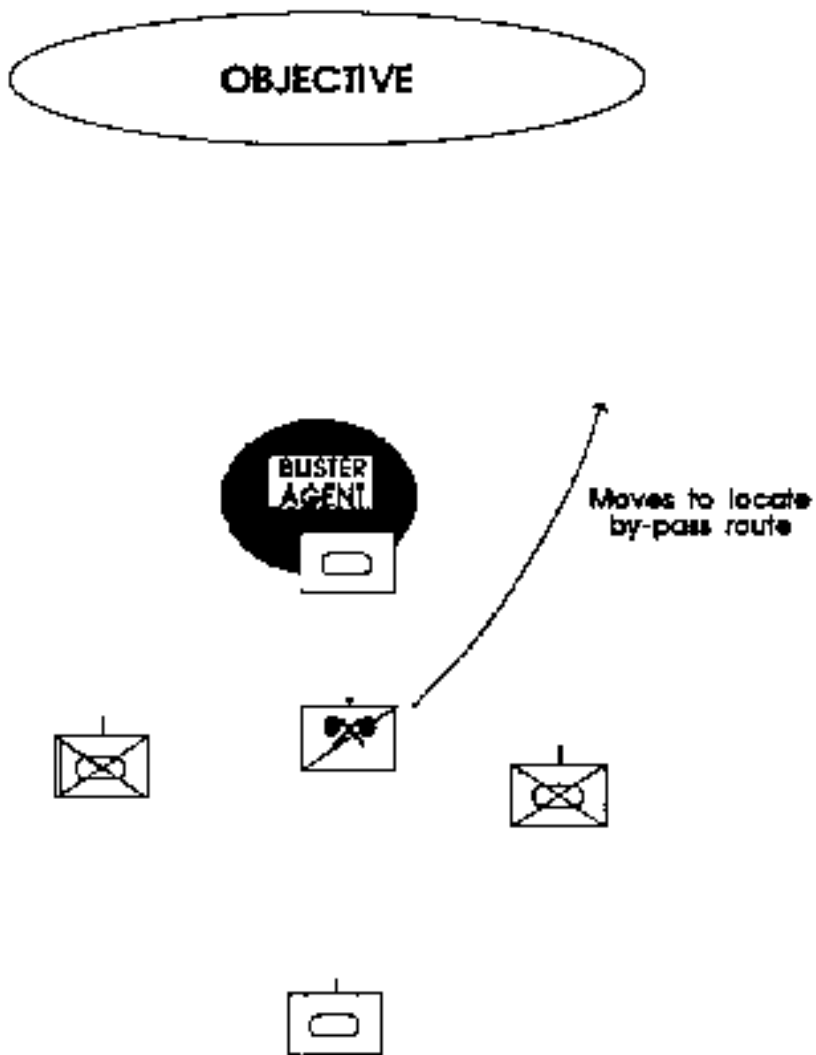

Figure 2-5. NBC recon squad supporting a task force.

NBC recon units can perform conventional recon missions. After NBC warfare has been initiated, the employment of NBC recon units in conventional recon roles must be approved by corps/division commanders.

## **REAR AREA COMBAT OPERATIONS**

Chemical units may be reorganized to function as a reaction force to defeat up to level II and delay level III rear area threats (see [Figure 2-6](#) for rear area threat levels). Additionally, chemical units can assist in area damage control (ADC). The decision to reorganize chemical units must be carefully weighed against the current NBC threat. The reorganization decision is made by the parent organization.

Response forces are the initial force to respond to a threat within their area of operations. This force destroys the enemy within their capability. If the attack is by an enemy force beyond the capability of the response force, the response force will--

- Delay and disrupt the enemy force.
- Request additional support from the rear area operations center (RAOC).
- Attempt to learn the size and intent of the enemy force.

Once reorganized, chemical units will come under the control of a RAOC. The RAOC will position the response force on the battlefield to provide security and react to enemy rear threats. [FM 90-14](#), *Rear Battle* provides an in-depth discussion of rear battle operations.

Area damage control are those actions taken before, during, and after hostile action or natural disasters to reduce the probability of damage and to minimize its effects. Chemical units can respond to the affected area and provide immediate assessment of the damage. Decon units can provide limited fire-fighting services. NBC recon units can determine the type and extent of hazards if NBC weapons were used or commercial chemicals involved. Decon units can establish decon sites as necessary. The RAOC for the affected area will establish command and control over units providing ADC support.

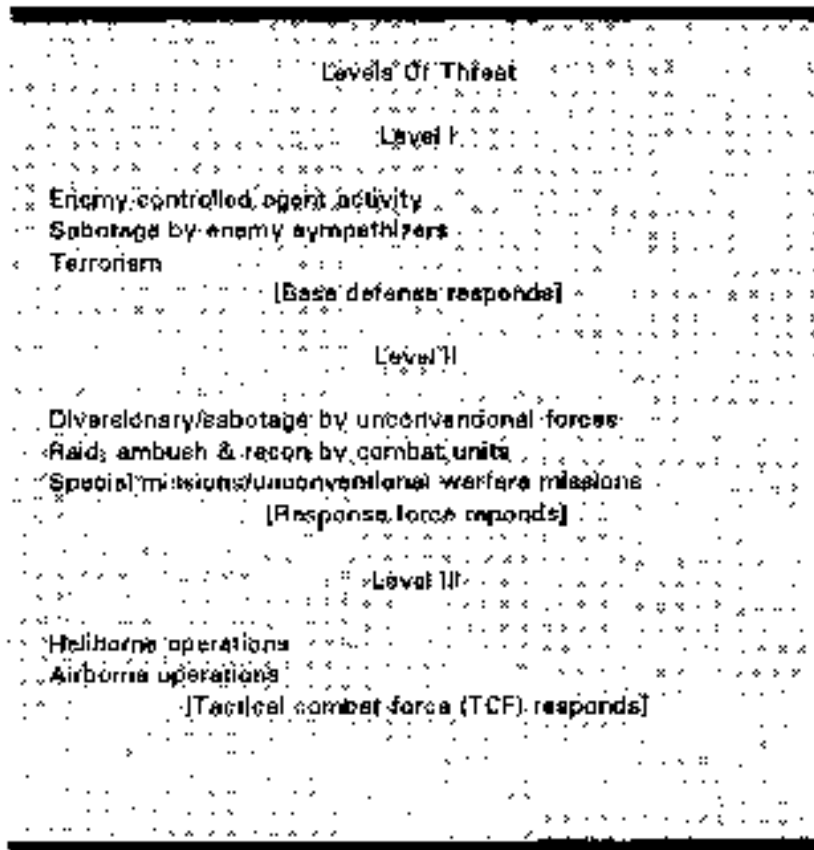

Figure 2-6. Rear area threat levels

[RDL](#)[Table of](#)[Document](#)[Download](#)[Homepage](#) [Contents](#) [Information](#) [Instructions](#)

---

## CHAPTER THREE

# CHEMICAL UNIT PLANNING

Planning for the employment of chemical units is a continuous process by both the supported and supporting unit. Planners take the commander's intent and guidance and develop the plans. Both current and future actions should be considered.

## COMPONENTS

### MISSIONS

Examine the mission. Plans should cover ways to enhance the survivability and mobility of friendly forces and assist in the regeneration of combat power. Plans should include both the forward combat area and the rear areas.

### AVAILABLE RESOURCES

Plans should include--

- Organic chemical assets.
- Resources available from higher headquarters.
- Materials and equipment available from the host nation.

### COORDINATION

Chemical unit planning must be coordinated with all staff elements, especially the operations (G3/S3) and logistics (G4/S4) sections. Understanding the enemy NBC threat is critical and requires close coordination with the intelligence (G2/S2) section. Maneuver must not

be restricted by friendly smoke operations. The employment of NBC recon elements should not duplicate the effort of conventional recon assets. Decontamination operations are resource intensive and require a large amount of coordination with the logistics staff sections. Careful deployment and coordination with adjacent and supported units and fire support elements will enhance chemical unit survivability. Friendly units must know the location and intent of all chemical units to avoid fratricide ("friendly fire"). Chemical unit operations must be logistically supportable.

## **SIMPLICITY**

Planners should exclude unnecessary elements and reduce essential elements to the simplest form. They must eliminate all possibilities for misunderstanding.

## **ORGANIZATIONAL RELATIONSHIPS**

Clearly define command and support relationships and fix responsibilities.

## **CONTINUITY**

Designate an alternate headquarters to assume responsibility if the primary headquarters is out of action.

## **VERSATILITY**

Chemical units must be able to react to unexpected situations. To weight the offense or defense, commanders must be prepared to shift chemical unit's from sector to sector and provide chemical unit support throughout the depth of the battlefield.

## **EFFECTIVE CONTROL**

Chemical units will operate away from their parent units. Electronic and NBC warfare, along with the sheer size of the battlefield, will make communications difficult. The plan must establish a command and control system and provide specific measures to adopt in the absence of direct communications links or control. The commander's intent must



provide the understanding necessary to continue actions in the absence of other guidance.

## **DECENTRALIZED EXECUTION**

Delegate authority, yet keep necessary control. Within available time, planners must develop the recommended chemical unit task organization, establish priorities, determine specific task and area responsibilities, and coordinate as necessary. Before implementation, chemical unit plans are coordinated with the force staff and approved by the force commander.

## **TASK ORGANIZATION**

---

### **CHAPTER 4 CONTAINS A DETAILED EXPLANATION OF COMMAND AND SUPPORT RELATIONSHIPS**

---

The various command and support relationships provide a wide range of options for task organizations. To select the best relationship, commanders and staff planners must study the situation and its requirements. The selected task organization must provide the most responsive, effective chemical support to facilitate future operations. When maximum control is needed, attachment and operational control are the best. Attachment and OPCON are best when situations are uncertain, communications are unreliable, logistical support is required from the supported unit, or a need exists to task organize at subordinate levels.

On the other hand, when the senior commander needs flexibility in changing priorities or shifting assets, general and direct support relationships are appropriate. They are also appropriate for short-term, area, or rear area support.

In addition to the command or support relationship selected, there are several other significant considerations in allocating chemical resources. The apportionment of chemical assets will be based on the mission, the enemy, the terrain, and the chemical units, equipment, materials, and time available. Because resources are limited, chemical

assets will often concentrate in vital areas rather than be distributed throughout the force. This should be worked out by the chemical staff and commander, based upon decisions and guidance of the force commander.

Plans are made for smoke and NBC recon support to the reserve upon its commitment. These plans should be made early enough for proper preparation. Although smoke and NBC recon units are not normally held in reserve, commanders must consider the survivability of the reserve forces when allocating chemical assets.

Chemical unit support of the forward maneuver forces must be balanced with support of rear area operations. Understanding enemy capabilities and intent of NBC weapons use will be critical in determining the balance of support to forward maneuver units and to rear areas.

Habitual relationships should be considered when allocating chemical units. This means that it is beneficial to have the same chemical unit support a given unit. By creating habitual relationships, mutual confidence and respect are developed between the chemical unit and the supported unit. This habitual relationship starts with peacetime training to build confidence, develop mutual understanding and respect, ease problems of coordination, and strengthen cohesiveness on the battlefield.

## **PRIORITIES AND TASKINGS**

Commanders at all levels must clearly specify priorities and taskings for chemical unit support. Plans must consider the entire spectrum of chemical unit support. This includes NBC recon, large-area smoke generation, decontamination, and chemical staff support. Commanders also must consider the resources needed to move the materials necessary for smoke and decontamination operations. The responsibilities of each chemical unit must be clearly established.

## **COORDINATION OF SUPPORT**

Chemical officers, commanders and staff officers, at all levels are responsible for coordinating chemical unit support. Request for support from subordinate units are consolidated and implemented in a timely manner. If insufficient chemical support is available at their level, requests for support are forwarded to the next higher

headquarters.

## **CHEMICAL UNIT ESTIMATE**

The chemical unit estimate is an orderly step of the planning process in command and staff actions. It is a realistic appraisal of the effort required to support an operation. It serves as the basis for chemical unit task organization.

With the commander's mission analysis and planning guidance, the chemical officer identifies the advantages and disadvantages of each course of action. A recommendation is developed from the best course of action. The chemical officers base their estimate on mission, enemy, terrain and weather, troops, and time available (METT-T).

## **MISSION**

The chemical officer must consider the commander's mission analysis and guidance. He must determine any stated and implied missions in the chemical area. He must consider the type of units supported, their equipment, and their status.

## **ENEMY**

The chemical officer analyzes the enemy, his likely courses of action, and NBC capabilities. He must know the enemy's capability to attack, defend, delay, or reinforce, and the type, range, and amount of NBC weapons available to them. An understanding of the enemy's target acquisition systems will determine the type and amount of smoke support needed. Understanding where and when the enemy may employ NBC weapons will allow the planner to focus the effort and allocation of NBC recon assets. Additionally, decontamination needs can be determined by knowing what units could become contaminated.

## **TERRAIN AND WEATHER**

Terrain analysis will indicate how the enemy may employ NBC weapons. Of greatest concern are avenues of approach, existing obstacles such as gaps, difficult terrain (such as wooded, mountainous, or urban areas), and defiles. The effect of the terrain on smoke operations must be considered. The effects of weather on NBC and smoke operations

must be considered. Additionally, the mobility of chemical units under adverse weather conditions needs to be addressed. Weather also controls the duration of chemical hazards.

## **TROOPS AVAILABLE**

The chemical officer considers the type and number of available chemical units. The status and capabilities of each chemical unit is also considered as well as the availability of resources such as decontaminants and fog oil.

## **TIME AVAILABLE**

Time is a major factor in determining the amount of chemical support available. The time required to move chemical units around the battlefield must be considered when developing a plan. The time required by various chemical units to perform selected missions also must be considered. A decontamination platoon can only decontaminate a finite amount equipment in a given period. This is also true for an NBC recon unit. A recon platoon can only reconnoiter a given area of terrain in a given time. The chemical officer must keep these factors in mind throughout the estimating process.

## **DEVELOPING THE ESTIMATE**

The chemical unit estimate allows the chemical unit commander to quickly, thoroughly, and logically conduct his analysis.

### **Mission**

The chemical officer restates the mission from the commander's mission analysis. All assigned specific and implied tasks are considered.

### **Situation and Courses of Action**

The chemical officer determines all facts or logical assumptions that influence the situation and choice of a course of action. From the METT-T analysis, he includes the terrain and weather characteristics and the enemy and friendly situations.

The chemical officer lists the tactical courses of action from the commander's guidance. He may include additional courses of action, if appropriate. He determines the chemical unit support required to support each course of action. He considers contamination avoidance, protection, decon, and large-area smoke support requirements. The corps estimate focuses on the requirements of the chemical battalions, the division estimate for chemical companies, and the brigade for chemical platoons. At this point the estimate is unconstrained by resources. This technique allows the chemical officer to consider all needs and advise the commander of the support requirement for each level. It also enables the chemical officer to respond quickly to changes in time and resources. He then compares estimated resources to available resources. If significant shortfalls exist, he evaluates the requirements by priority and revise the estimate until the planned requirement matches resources available.

### **Analysis of Courses of Action**

The chemical officer in conjunction with the remainder of the staff wargames each course of action and determines the probable outcome. Enemy opposition is also considered during the wargaming process. The advantages and disadvantages of each course of action is determined.

### **Comparison of Courses of Action**

The chemical officer compares the advantages and disadvantages of each course of action. He decides which course of action will be most successful for the mission. This can be accomplished through the use of a decision matrix.

### **Recommendation**

In his recommendation, the chemical officer addresses the allocation of chemical units: task organization, command and support relationships, and priority of support. Before presenting the estimate to the commander, the chemical officer coordinates with key staff members. The chemical officer then provides the commander a complete recommendation telling who, what, when, where, why, and how. The estimate may be written or oral. The chemical officer may give an oral briefing separately or as part of the G3/S3 estimate.

## COMMANDER'S DECISION

Having heard the chemical officer and other staff estimates, the force commander announces his decision. With his chemical officer's advice, the commander specifies his concept for the commander's decision. The staff then prepares the orders.

## CHEMICAL UNIT COMBAT ORDERS

Based on the force commander's decision for chemical unit employment, the plans and orders are prepared. The chemical unit either prepares or provides advice for the preparation of the chemical unit portion. When a chemical staff section is present on the force's staff (corps--corps chemical section, division--division chemical section), this staff section normally prepares the chemical portion of plans and orders. This will be accomplished in close coordination with the chemical unit S-3. Combat orders for chemical operations are issued from all headquarters in the name of the commander.

At division and corps levels, operations orders and administrative and logistics orders usually contain separate chemical support annexes. At echelons below division, orders are less formal and, on occasion, may be oral. A chemical support combat order should be--

- Clear. All agencies must understand it thoroughly.
- Complete. Required information and instructions to coordinate and execute the operation.
- Brief. Unnecessary details are avoided. However, clarity and completeness are not sacrificed for brevity.
- Accurate.
- As unrestrictive on subordinate commanders as possible.
- Timely. Chemical support orders must allow subordinate commanders adequate planning and preparation time.

## OPERATIONS ORDERS

Chemical units will prepare orders for their subordinate element. At the chemical brigade and battalion level, these orders are normally written products. At the chemical company level, orders can be either written or oral, depending on the amount of time available. If the company prepares a written order, it is normally of a matrix format (see [Appendix F](#)). Chemical staffs will prepare chemical support annexes or include instructions in the basic orders outlining tasks and responsibilities to supporting chemical units.

## **FRAGMENTARY ORDERS**

Fragmentary orders are issued in lieu of a complete order in fast-paced combat situations. They provide specific instructions to commanders or timely changes to existing orders. Fragmentary orders do not have a specified format. However, the five-paragraph combat order format is normally used. It will include only necessary elements changed from the original order. The fragmentary order may be issued orally. Generally, the fragmentary order--

- Is addressed to each action commander.
- Is provided for information to higher and adjacent units for information, as applicable.
- Refers to a previous order.
- Includes changes in task organization, situation, and mission.
- Clearly provides brief and specific instructions.

Following the commander's approval, the plan or order is published and the chemical unit staff begins action to ensure timely and proper execution- -a key element of the battle command.

[RDL](#)[Table of](#)[Document](#)[Download](#)[Homepage](#) [Contents](#) [Information](#) [Instructions](#)

---

## CHAPTER FOUR

# BATTLE COMMAND

Battle command is the authority exercised by commanders in organizing, directing, and controlling the activities of a military force to accomplish a mission. All commanders exercise this authority with personal leadership and through the staff. Plans, orders, and standing operating procedures implement the commander's decisions. The battlefield operations will challenge ability of chemical commanders and staffs to command and control chemical units. The extended battlefield, with deep operations and rear area operations, demands a command and control system that carries out the commander's intent, adjust quickly to changes, and provides for centralized planning and decentralized execution. The command and support relationship that gives most responsive chemical support to the supported unit must be selected.

Additionally, the battle command system must--

- Keep the commander informed.
- Clearly define functional responsibilities for the staff.
- Assign missions within capabilities of subordinate units.
- Provide continuous coordination among staff elements.
- Provide continuous coordination and exchange information between the commander and staff.
- Protect the commander from nonessential information.
- Operate with such efficiency and speed that the information, decision, action, and follow-up cycle is regularly completed



faster than that of the enemy.

## TASK ORGANIZATION

---

Detailed examples of the task organization process at corps to brigade level are located in [chapters 7](#) and [8](#).

---

Task organization designates the command or support relationship of subordinate units. The basic rule in task organizing is never assign a more authoritative command relationship than received from higher authority. A unit received in attachment may be attached, placed under OPCON, or given a support mission to a subordinate headquarters. A unit under OPCON of a force headquarters, however, may not be attached to a subordinate unit. At corps and division levels, commanders divide the chemical support effort among subordinate elements and rear areas based on METT-T. Considerations which must be addressed are--

- Continuing mission requirements in each area.
- Available time and resources.
- Need for rapid shifting of chemical forces.
- Command and support relationships.
- Availability of logistical support.
- Status of chemical units.

The corps and division chemical officers advise their respective commanders during the decision making process. Forces are allowed and command or support relationships are established based on METT-T. The task organization must allow forward commanders maximum flexibility consistent with the mission and situation.

When distances prevents chemical unit headquarters from exercising effective control and support of subordinate units. Chemical units should be attached or placed under operational control of the division or division's major subordinate commands (MSC). This authority gives

the supported commander full control over the chemical elements. It enables him to further task organize the chemical units for flexible and responsive support to his subordinate echelons. Responsiveness is gained by shortening the tasking channels. A commander with chemical units attached or placed under operational control can quickly assign tasks throughout his area of operations. In other situations, a support relationship may be more appropriate to preserve flexibility of the senior commander in shifting chemical assets. These support relationships do not include command authority and do not permit further task organization.

When a division is supported by a chemical battalion, the division chemical company should be placed under its operational control. This allows the logistical support relationships between the division chemical company and the CSS units of the division to be retained. If the chemical battalion will support the division for a prolonged time, the division chemical company could be attached to the chemical battalion.

The brigade and battalion task force chemical officers in conjunction with the chemical unit commander recommend a command or support relationship to the maneuver commander. When selecting the task organization, the supported brigade and battalion commanders should consider the factors and specific capabilities of the supporting chemical units. A chemical company can control up to six platoons. A chemical battalion can control up to seven companies. Chemical platoons are most effective as a unit, therefore platoons should not be subdivided. Squads separated from the platoon have limited capabilities. Since most chemical support requires a concentrated platoon effort, chemical platoons should normally be considered an integral unit in task organization. NBC reconnaissance units are exceptions and are capable of being task organized down to team level.

If more than two chemical platoons are allocated to support a unit with no organic headquarters, the supporting chemical battalion should consider designating a chemical company headquarters to act as the company team headquarters. The chemical company team is a temporary grouping of chemical platoons under a chemical company headquarters, formed to carry out a specific operation or mission. This provides increased command, control, and communications. Administration and logistical support is provided to the chemical platoons through the team headquarters.

### **EXAMPLE**

To support the breaching of a complex obstacle system, the 1st Brigade, 52d Infantry Division (M) will be supported by two mechanized smoke platoons, a decontamination platoon, a NBC recon squad, and a fuel support squad. The 89th Chemical Battalion is OPCON to the division. To provide a more responsive chemical organization to the 1st Brigade, the chemical battalion commander has decided to designate the 210th Chemical Co (Decon) headquarters as a chemical company team. The chemical platoons designated to support the 1st Brigade are attached to the 210th Chemical Co.

## **RELATIONSHIPS**

Chemical units can operate under two types of relationships - command and support. [Table 4-1](#) summarizes command and support relationships and their inherent responsibilities. Command responsibility and authority are established through command relationships. Support relationships are established to define specific relationships and responsibilities between supporting and supported units. Command responsibilities, responsibility for logistic support, and the authority to reorganize or reassign component elements of a supporting force remains with the higher headquarters or parent organization unless otherwise specified.

### **COMMAND**

Chemical units can operate under four command relationships: organic, assigned, attached, and operational control (OPCON).

#### **Organic**

A unit that forms a part of a unit and is listed in the table of organization. Organic chemical units are found in armored, mechanized, infantry, airborne, and air assault divisions and armored cavalry regiments. They may be attached, under the operational control, or given a direct support mission to subordinate elements in the parent organization. They also may be retained in general support of the

entire parent organization.

## **Assigned**

Assigned units are placed under control of higher headquarters, usually above division level, on a relatively permanent basis. A chemical brigade is generally assigned to corps. The chemical brigade has assigned chemical battalions, companies, and detachments. The chemical brigade is tailored to fit the corps based on the area of operations and the enemy threat.

Assigned units may be attached, placed under operational control, or given a direct support mission to a subordinate element of the parent unit. Assigned units also may be retained in general support of the entire parent command.

## **Attached**

When a unit is attached to another, usually a larger unit, it is mostly for an extended period of time. Except for limitations imposed by the attachment order, the gaining commander exercises command and control over the attached just as over organic and assigned units. All command and logistic responsibilities are his also, except for personnel transfers and promotions. These actions are retained at the parent organization, unless otherwise specified in the attachment order.

### ***Example***

The 44th Chemical Co (Smoke/Decon), 89th Chemical Battalion is attached to the 1st Brigade, 52d Infantry Division (M). The brigade commander can attach, place under operational control, or place in direct support to any of his battalions or task forces, the various chemical platoons of the 44th Chemical Co. He can retain any platoon or all of them in general support of the brigade. Therefore, he can task organize in a variety of ways to best support his concept of the brigade mission. Commander, 89th Chemical Battalion has no command, control, or logistical support responsibility for 44th Chemical Co as long as it is attached to the 1st Brigade, except for personnel matters such as transfer or promotion, unless specifically stated in the attachment order. 44th Chemical Co establishes and maintains

communications with 1st Brigade and is not required to maintain communications with the 89th Chemical Bn. The forward support battalion supporting the 1st Brigade provides logistic support to the company.

Attachment should be considered when time or space preclude the parent headquarters' ability to logistically support the unit or make timely command decisions. Attachment permits the supported commander flexibility in task organizing the chemical elements and tailoring them for responsiveness to maneuver forces. An attached unit or its subordinate elements may be further attached, placed under operational control, or assigned a direct support mission to a subordinate unit. It also may be retained in general support of the entire force.

## Operational Control

With operational control (OPCON), the gaining commander can use the chemical unit as he would his organic units for mission accomplishment. This includes task organizing subordinate forces, assigning tasks, and designating objectives. However, the parent unit retains responsibility for the chemical unit's logistical and administrative support, unless specified in the order. For example, the gaining commander can be ordered to furnish POL support to the unit.

### *Example*

The 44th Chemical Co (Smoke/Decon), 89th Chemical Battalion is under OPCON of 1st Brigade, 52d Infantry Division (M). The brigade commander can place any or all the platoons of the 44th Chemical under OPCON or DS to any of his battalions or task forces. He can retain any platoon or all of them in general support of the brigade. The brigade commander cannot, however, attach the chemical platoons to the battalions, because a commander can never pass on more command authority than received from higher headquarters. The Commander, 89th Chemical Bn is responsible for all administrative and logical support unless otherwise specified. The chemical battalion commander has no operational command authority over the company. The 44th Chemical Co establishes and maintains communications with 1st Brigade and maintains communications with the 89th Chemical Bn.

Chemical units are placed under OPCON of the supported unit to ensure responsiveness to the supported unit's plan when time, distances, or difficult communications require decentralization, and when further task organization by subordinate units may be necessary. This command relationship can place a severe logistical burden on the parent chemical organization. Consequently, this command relationship is normally used with a short operation and when logistical support from the supported unit is not available. A unit placed under OPCON to a headquarters also may be placed under OPCON of a subordinate unit, given direct support missions to a subordinate unit, or retained in general support.

## **SUPPORT**

A support relationship is established when chemical units are placed in direct support (DS) of a force or when the commander elects to retain chemical units in general support (GS) of his command. In both DS and GS relationships, command responsibility is retained by the parent chemical unit. Full logistic responsibility rests with the parent unit unless the supported unit is directed to fulfill certain logistical functions such as ration, POL, or medical support.

### **General Support**

A commander with organic, assigned, attached, or chemical units under OPCON may elect to retain any part of those assets in general support (GS). Chemical units are retained in GS when higher headquarters requires greater flexibility and control. A command receiving chemical units GS from a higher headquarters retains those assets in GS to the command. In this relationship, support is to the force as a whole, rather than to a particular subdivision of the force. The subordinate force commander requests support from the senior force commander, task by task, rather than from the supporting unit. The commander sets the priorities and assigns the tasks of the GS unit. Chemical units in rear areas are typically employed in GS. That support too, is provided to the entire force rather than to a specific unit.

Retaining a chemical unit in GS ensures that the tasking supported commander maintains control of those chemical assets throughout this area of operations. It enables him to redirect priorities as his concept of the operations develops or as the situation changes. Subordinate commanders have little flexibility and no control over GS

chemical units in their areas. Long lines of authority decrease responsive support to units. A GS mission is best for chemical units operating on a task or area assignment.

### ***Example***

The 89th Chemical Bn is given a GS mission in the operations order. One of the assigned Gs tasks is to establish and operate decontamination sites in the 394th CSG area of support. The 51st Maintenance Co is contaminated and requires decontamination support. The maintenance company request decon support from the CSG, who in turn sends the request to the 89th Chemical Bn. The 89th Chemical Bn assigns the mission to the 200th Chemical Co (Decon). The maintenance company is directed to coordinate directly with the 200th Chemical Co. Neither the CSG or the maintenance company have any direct control over the decontamination operation or the chemical units in their areas.

## **Direct Support**

A DS unit provides dedicated support to a specific unit, usually for a single operation or a short time. DS gives the supported unit commander a high degree of control of the tasks performed by the supporting unit without assuming responsibility for its logistics or administration. The supporting unit will take task assignment and priorities from and give priority of support to the supported unit. Command authority, logistics and administration are retained by the parent unit. This relationship precludes further task organization. Tasks and priorities are assigned by the force commander. Chemical units placed in DS of maneuver elements remain under command of the parent unit. They perform chemical tasks requested by the supported force commander.

### ***Example***

The 89th Chemical Battalion is placed in DS of the 52nd Infantry Division (M). The commander of the battalion will task organize the battalion as needed to accomplish the chemical tasks requested by the division commander. If chemical tasks exceed the capabilities of the battalion, the Commander 89th Chemical Bn will request additional chemical support from the 510th Chemical Brigade. The 52nd Division Commander has no command authority over the 89th Chemical Bn, but can specify tasks and priorities to Commander, 89th Chemical Bn. Neither the companies nor any subelement of the 89th Chemical Bn can be suballocated to any subordinate division units in any command or support relationship. The entire battalion must be retained in Gs of the division. The 89th Chemical Bn could also have a task or area assignment in conjunction with the DS mission. 89th Chemical Bn maintains communications with the division and the 510th Chemical Bde. Logistics support contains to come from corps and the 510th Chemical Bde.



Table 4-1. Command and support relationships.

Inherent Responsibilities										
	A chemical element with a relationship to:	Is commanded by:	Maintains liaison and communications with:	May be task organized by:	Can be:	Responds to support requests from:	Has its work primarily accomplished by:	Makes its spare work effort available to:	Forwards requests for additional support through:	Receiver logistic support from:
SUPPORT RELATIONSHIP	Parent support (CS)	Parent unit	Supported and parent units	Parent unit	Deactivated to support a particular unit. May be given task or area assignments.	Supported unit	Supported unit	Parent unit	Parent unit	Parent unit
	General support (GS)	Parent unit	Supported and parent units	Parent unit	Used only to support the parent force as a whole. May be given an area or task assignment.	Parent unit	Parent unit	Parent unit	Parent unit	Parent unit
COMMAND RELATIONSHIP	OPCON	Supported unit	Supported and parent units	Supported unit	Placed OPCON to a unit of chemical or molecular units or made DS to Role's or task forces.	Supported unit	Supported unit	Supported unit	Supported unit	Parent unit
	Attached Assigned	Supported unit commander	Supported units	Support unit commander	Further attached OPCON or DS to Role's or task forces or retained US.	Supported unit	Supported unit	Supported unit	Supported unit	Supported unit

NOTES:  
 1. It is possible that units will receive additional chemical support without a command relationship - the support relationship of DS to the division.  
 2. When attached, the chemical element is provided administrative/logistic support.

## COMMAND AND SUPPORT INTEGRATION

Command and support relationships for chemical units can be combined to meet the needs of the command.

### ***Example***

The 67th Chemical Battalion is attached to 52d Infantry Division (M). The chemical battalion consists of the 77th Chemical Co (Mech Smoke), 41st Chemical Co (Motor Smoke), and the 66th Chemical Co (Decon). The division chemical company, the 44th Chemical Co, is OPCON to the 67th Chemical Bn. The division scheme of maneuver is to defend a portion of their sector with 1st Brigade, conduct a limited objective attack with 2d Brigade, and attack to seize a deep objective with 3d Brigade. The division commander could task organize to place the 66th Chemical Co (Decon) is GS of the division, attach the 77th Chemical Co (Mech Smoke) to the 3d Brigade, place the 41st Chemical Co (Motor Smoke) OPCON to 2d Brigade, and form a chemical company team with the 44th Chemical Co and place it in DS to 1st Brigade.

## **FUNCTIONS**

### **DUTIES AND RESPONSIBILITIES**

To achieve success on the modern battlefield, commanders and chemical officers - both as staff officers and commanders - must create an effective and efficient command and control system for chemical support efforts. Chemical staff officers must clearly understand their responsibilities and relationships with supported commanders and their staff elements. The chemical officer must be continuously aware of significant developments. Chemical unit commanders must ensure that their forces are responsive and supportive of the supported unit commanders intentions. When the chemical officer is both the staff officer and the unit commander, as with the corps, the commander must observe the requirements and tasks of both responsibilities.

### **Supported Commanders**

The supported unit commander, maneuver, combat support, or combat service support, has the responsibility for organization, planning, coordination, and effective use of chemical units in accomplishing their mission. At the battalion level and above, the commander is

normally assisted by a chemical officer or NCO. This assistance does not alter the commander's responsibility to accomplish his mission through the informed use of his staff. The commander's responsibilities does not reduce the chemical officers/NCO task of analysis, evaluating, recommending courses of action, and supervising implementation of the commander's decision. With advice from the chemical staff officer/NCO, the commander assigns missions and priorities to his units and supporting chemical units.

### **Unit Chemical Officer/NCO**

The unit chemical officer/NCO is the principal advisor to the force commander for all chemical matters. He is the staff officer/NCO, responsible for proper chemical support to all elements of the force according to the decisions and priorities in support of the force. of the force commander. He performs staff planning and coordination for all chemical units He is responsible for staff supervision during the execution of chemical support operations.

### **Theater Army Chemical Officer**

The theater army chemical officer is a member of the theater army's special staff. He has no command responsibilities. He integrates NBC defense into the theater army's plan to sustain Army forces and support other services or allied forces. He helps determine requirements for chemical units. Then he takes the necessary actions to identify and prioritized assets to fill those requirements and get them to the tactical commander in a high state of readiness. He may also act as the Army component chemical officer.

### **Corps Chemical Officer**

Provides advice to the corps commander on all matters regarding NBC defense, the employment of chemical units, and the use of smoke, flame, riot control agents, and herbicides. In conjunction with the Fire Support Element, he advises on employing nuclear weapons maintained by the other services and the effects from employing those weapons. He operates the corps NBC warning and reporting system (NBCWRS) and prepares the necessary staff estimates, operational plans and orders to accomplish the corps mission.

When a chemical brigade is assigned to the corps, the corps chemical officer works closely with chemical brigade commander to improve and execute chemical support throughout the corps area of operations. Since the brigade commander's staff is small, the corps chemical staff assists the brigade in coordinating logistical support and planning operational missions.

[Tables 4-2](#) and [4-3](#) show more details on the responsibilities of the chemical brigade commander and the corps chemical officer.

Table 4-2.

<b>Primary Functions of the Corps Chemical Staff</b>	
<b>Principal members:</b>	
	Corps chemical officer
	Brigade commander as required
	Chemical staff officer (plans)
-	Integrates chemical support into plans for future operations
-	Provides NBC defense advice to corps commander and staff
-	Maintains communications with chemical brigade
-	Relays chemical unit information as necessary to other C2 elements
-	Tracks current operations
-	Operates the NBCWRS and processes all reports of NBC attacks
-	Tracks critical sustainment issues

## Chemical Brigade Commander

The chemical brigade commander commands the chemical units assigned to the corps. He issues detailed plans and orders to support the corps' mission. Mission orders from the corps commander are normally passed through the corps chemical officer. This relationship allows the brigade commander to focus his units on their part of the corps battle

plan, while the corps chemical officer provides support in sustaining the brigade and prioritizing its missions. [Table 4-3](#) provides more details.

The corps chemical staff provides the corps commander and the corps staff with advice on NBC defense and smoke employment. The chemical staff also receives and analyzes NBC attack information. The section provides advanced warning of future corps operations through chemical channels to the chemical brigade and subordinate chemical staff sections (division, separate brigades, and ACR).

Table 4-3.

### Primary Functions of the Chemical Brigade Staff

#### Principal members:

Brigade commander  
Deputy commander  
Operations officer  
Intelligence officer  
Personnel officer  
Logistics officer

- Controls all chemical assets assigned, attached, OPCON, DS, or GS
- Plans, synchronizes, coordinates, and monitors chemical unit operations  
coordinates and troubleshoots logistical support for subordinate units
- Plans and synchronizes future logistical support for the brigade and subordinate chemical units
- Relays chemical information as necessary to other command and control elements tracks status of all chemical units in the corps
- Develops order of battle and situation for subordinate units
- Sustains subordinate units integrates chemical units into rear operations solves chemical unit unique maintenance problems
- Provides timely SITREPS to corps chemical section

The corps chemical staff monitors the status of the chemical units

through the chemical brigade staff. The corps chemical staff crosstalks within subordinate chemical staffs to insure all their operational requirements for chemical support are being met.

The brigade staff coordinates for the movement of subordinate chemical units with the corps area, The brigade staff also coordinates the logistical support for the subordinate elements and serves as the logistical interface with the DISCOM/CSG/COSCOMs.

Once the order/plan is issued, the chemical brigade staff and chemical staff section must look at the next mission. The brigade staff must look out approximately 72 hours to anticipate the sustainment needs and task organization of subordinate chemical units.

The corps chemical staff analyzes NBC attack information and recommends changes in support priorities. Information is constantly exchanged between the corps chemical staff and the brigade staff.

## Division Chemical Officer

The division chemical officer is a special staff officer assigned to the division. When the division is supported by a chemical battalion, the battalion commander will not assume the duties of the division chemical officer. Chemical battalions supporting a division are normally for a finite period of time and changes of duties and responsibilities would be more disruptive than beneficial.

The division chemical officer serves as a member of the division staff and prepares the chemical staff estimates, recommends courses of action, prepares plans and orders for chemical support operations, and supervises all chemical support activities for the division commander. The division chemical officer coordinates all chemical support to the division for the commander. He coordinates closely with the supporting chemical unit commander and seeks their advice on the employment of their unit. The division chemical officer has operational control of the division chemical company. He is assisted by the tactical chemical operations officer (TCOO) and a chemical staff section in the division main and tactical command posts.

The relationship between the division chemical officer and the division chemical company is extremely important during both tactical and garrison operations. During tactical operations, the division

chemical officer, in the absence of a chemical battalion commander, exercises and maintains operational control over assigned and supporting chemical units. The division chemical officer provides technical and tactical guidance to the division chemical company commander. During garrison operations, the division chemical officer must continue to exercise influence over the chemical company even though it may be assigned to a subordinate command within the division. If the division chemical company is assigned to a subordinate command, the division chemical officer should--

- Develop a formal memorandum of understanding with the battalion commander to whom the chemical company is assigned.
- Retain tasking authority over the chemical company.
- Retain authority to assign officer and noncommissioned officer leaders to the company in coordination with the subordinate battalion commander.
- Act as the company commander's intermediate rater.
- Plan and execute all external evaluations of the chemical company.
- Participate in all company training briefs with the battalion commander.
- Take and maintain an active interest in all facets of the chemical company, from maintenance to training to quality of life of the soldiers.
- Mentor the company commander and other assigned officers.

## **Brigade and Regimental Chemical Officer**

Brigade and regimental chemical officers advise commanders on chemical matters and are responsible for chemical staff supervision. In brigades and regiments, a chemical officer organic to the staff prepares the chemical estimate and written portion of plans and orders. The brigade or regimental chemical officer provides staff coordination and supervision of chemical support operations, conducts battle tracking during operations, and maintains unit personnel,

equipment, and supply status, He monitors the actions of subordinate chemical officers to ensure synchronization. In the case of armored cavalry regiments and separate combat brigades, the chemical officer is assisted by a small staff located in the main and tactical command posts. In other brigades and like commands, the chemical officer is assisted by a chemical operations NCO.

### **Special Forces Group Chemical Officer**

The special forces group chemical officer advises the group commander on chemical matters and is responsible for chemical staff supervision. He prepares the chemical estimate and written portion of plans and orders. He has operational control of the chemical detachment operating in support of the group. These chemical detachments provide NBC staff and decontamination support. Additionally, NBC reconnaissance support may be provided to the group.

### **Battalion/Task Force Chemical Officer**

When the task organization sets up a command or support relationship between a chemical unit and a battalion or maneuver force, the supporting chemical unit commander or platoon leader does not assume the duties and responsibilities of the organic battalion/task force chemical officer. The battalion/task force would be supported by a chemical unit for only short periods of time and having the platoon leader or unit commander assume the duties and responsibilities of the battalion/task force chemical officer would be unduly disruptive. The battalion/task force chemical officer advises the commander on NBC defense operations and smoke matters, prepares informal estimates, and provides information for plans and orders. He has staff supervision of the execution of chemical support operations. He supervises and monitors NBC defense operations at company level in support of the company NBC NCO. He maintains the status of NBC personnel and equipment within the battalion. He coordinates closely with the brigade chemical officer and chemical unit commanders or platoon leaders and seeks their advice on employing and sustaining their unit.

### **MISSION COORDINATION**

When subordinate elements require decontamination, smoke, or NBC reconnaissance support, they pass their requirements to the next



higher headquarters. These requests for support should contain several critical elements of information. By providing all necessary information in the request for support, the next higher chemical staff can determine the criticality of the support and modify support priorities as needed.

**Table 4-4. Critical information requirements for mission coordination.**

Information	Decon	Smoke	Recon
Mission of supported unit	X	X	X
Location of supported unit	X	X	X
Location of NBC attack	X		X
Type/extent of NBC attack	X		X
Type of support needed	X	X	X
Time support is needed	X	X	X
Location of link up point	X	X	X
Amount/type of contaminated vehicles and personnel	X		

When providing a mission or tasking to a chemical unit, the staff should use mission type orders. Tell the chemical unit what, when, where, and why - not how. Provide sufficient information and guidance to allow the chemical unit to formulate its own plan to execute the mission or tasking. The staff should provide constraints and restraints as necessary. Communications between the supported and supporting units must be established early and maintained throughout the mission or tasking.

## EXECUTION

Effective control is critical to success of chemical support operations. In many cases, the distance between chemical unit headquarters exceeds the capability of the organic communications systems. Thus, plans and orders must establish simple organizational relationships and reliable communications between supported units and supporting chemical units. Procedures must be established to ensure the continuity of operations if communications fail. The supported

commander and the chemical unit must work closely to provide effective command and control. Areas that require particular attention include timely information, flexibility, continuity of operations, operations security, and communications.

The force commander exercises command and control over subordinate forces according to the mission or tasks assigned and within guidance from the next higher commander. The force commander must make all decisions concerning chemical support within his area of responsibility and must adjust chemical support priorities during operations. Commanders of battalions and higher echelons normally have a chemical staff to recommend the best use of available chemical units. The chemical staff should provide timely information on chemical operations, make routine decisions within delegated authority, and perform staff supervision of chemical operations.

The chemical staff must stay abreast of chemical support operations through staff visits and analysis of reports. He is in constant liaison with other staff elements, especially the intelligence (G2/S2), operations (G3/S3), logistics (G4/S4), and civil affairs (G5). He will keep the commander informed of significant developments, provide advice as appropriate, and ensure that chemical support operations remain flexible.

### **Timely Information**

The chemical staff must maintain accurate and timely information on two levels. The primary responsibility is to provide essential information to the commander. The format must be brief, clear and readily integrated into displays maintained by the operations and intelligence sections. Such information will include the location and capabilities of chemical units and equipment to include critical items such as NBC recon vehicles, power driven decontamination equipment, and smoke generators. Precise locations of decontamination sites and contaminated areas are vital.

### **Versatility**

The chemical staff must ensure that versatility is maintained throughout the operation. For example, in an attack a unit may encounter an unanticipated obstacle system. To preserve forward momentum, the commander must be able to concentrate the necessary

smoke support to conceal breaching operations. Or a reserve maneuver unit is hit by an enemy chemical attack and most of the vehicles are contaminate. The commander intends commit the reserve force within 12 hours and wants them in the lowest available MOPP level. He must shift all available decon units to support the reserve force.

The best method for chemical support flexibility is to plan for all possibilities. A task-organized chemical team comprised of smoke, decon, and NBC recon elements would be best placed under the control of each committed forward maneuver element.

## **Continuity of Operations**

Chemical unit operations in support of maneuver forces should be collocated with and controlled from the tactical operations center or tactical command posts of the supported unit. Maneuver battalions and higher echelons operate at least two command and control facilities to provide redundancy if one is destroyed. Additionally, the command posts move their locations frequently. Supporting chemical units must be prepared to operate in a like manner. Chemical units need to make the maximum use of liaison officers.

At the chemical company level, the company commander and his operations officer are responsible for coordinating with the supported unit. The company commander positions himself near the supported unit's main command post. At the chemical battalion level, the battalion commander needs to establish their command post near the supported unit's main command post. The chemical battalion also positions liaison officers in the supported unit's main and tactical command posts. The chemical brigade establishes their command post at the corps main command post. Liaison officers are positioned at the corps main and tactical command post. The brigade commander will position himself on the battlefield where he can best influence chemical support to the corps.

## **Operations Security**

Chemical unit command and control, as well as the conduct of planning and operations, must provide the safeguarding of both classified and unclassified information. Intelligence indicators susceptible to hostile exploitation must be identified and eliminated or controlled to protect military activities and to achieve security of the force.

Sources of information that require protection include communications, informative patterns and signatures - visual, acoustic, electronic, infrared - and stereotyped administrative and tactical procedures. Any source could signal friendly plans and readiness postures to hostile observers.

## **COMMUNICATIONS**

Communications play a critical part in command and control. Considering the battlefield area, distances over which chemical units will operate, and the threat capabilities, leaders must know communications and available communications equipment. The enemy will use all available means to disrupt, exploit, or destroy our ability to communicate.

### **Responsibilities**

Establishing communications is a command responsibility. Each chemical commander is responsible for establishing communications with the lower headquarters and with the unit being supported.

### **Capabilities**

The communications section of chemical brigade and battalion headquarters and each chemical company is organized and equipped to install, operate, and maintain the unit's communications system.

**Mobile subscriber equipment (MSE).** MSE is the area common-user voice communications system in the corps. MSE provides voice and data communications from the corps rear boundary to the maneuver battalion main command posts. All chemical units are equipped with MSE down to company level. MSE provides--

- Secure telephone service.
- Secure facsimile service.
- Secure mobile radiotelephone service.

- Secure data transmission.
- Combat net radio (CNR) network access.

MSE users are responsible for installing, operating, and maintaining their subscriber terminal equipment. Users are responsible for connecting and maintaining the wire lines to the distribution boxes or remote multiplexer combiner (RMC) installed by the supporting signal node. Subscriber terminal equipment includes--

- TA-1035 Digital nonsecure voice terminal (DNVT).
- TSEC/KY-68 Digital secure voice terminal (DSVT).
- AN/UGC-144 Communications terminal (CT).
- AN/UXC-7 Lightweight digital facsimile (LDF).
- AN/VRC-97 Mobile subscriber radiotelephone terminal (MSRT).

The corps and division signal organizations establish a network of line-of-sight multichannel radios and interconnected local and long-distance switching nodes. This provides an area coverage for the division and corps areas. MSE user need only to dial up and communicate with any discretely addressed MSE subscriber.

Mobile Users. When using the MSRT, the user gains access into the network through radio access units (RAU). Each RAU has a planning range of 15 km radius area coverage. As the mobile subscriber moves across the battlefield, affiliation is automatically maintained as he moves from one RAUs area to another. If he is using the MSRT at the time he changes from one RAU to another, the conversation is terminated and he must redial to reestablish the communication.

Static Users. Static terminal users gain access into the network through large extension node switch (LENS) or small extension node switch (SENS). A LENS can support up to 176 subscribers and are normally associated with COSCOM, DISCOM, corps main, or division main CPs. The SENS provides access for either 26 or 41 subscribers depending on it equipment. These are normally established with corps combat CPs (ACR, FA Bale, ADA Bale). The positioning of chemical unit headquarters will be greatly affected by the positioning and

availability of LENS and SENS.

## **Single-Channel Ground and Airborne Radio System (SINGARS).**

SINGARS is the family of VHF-FM radio sets that provides secure voice and data transmission capability. These radios transmit over a broad frequency spectrum using a frequency-hopping technique. SINGARS replaces the VRC-12 series radios on a one-for-one basis.

### **RADIO NETS**

Tactical FM communications are the most frequent means of communicating within chemical battalions and companies. [Figures 4-1](#) and [4-2](#) show typical communication nets for chemical brigades and battalions.

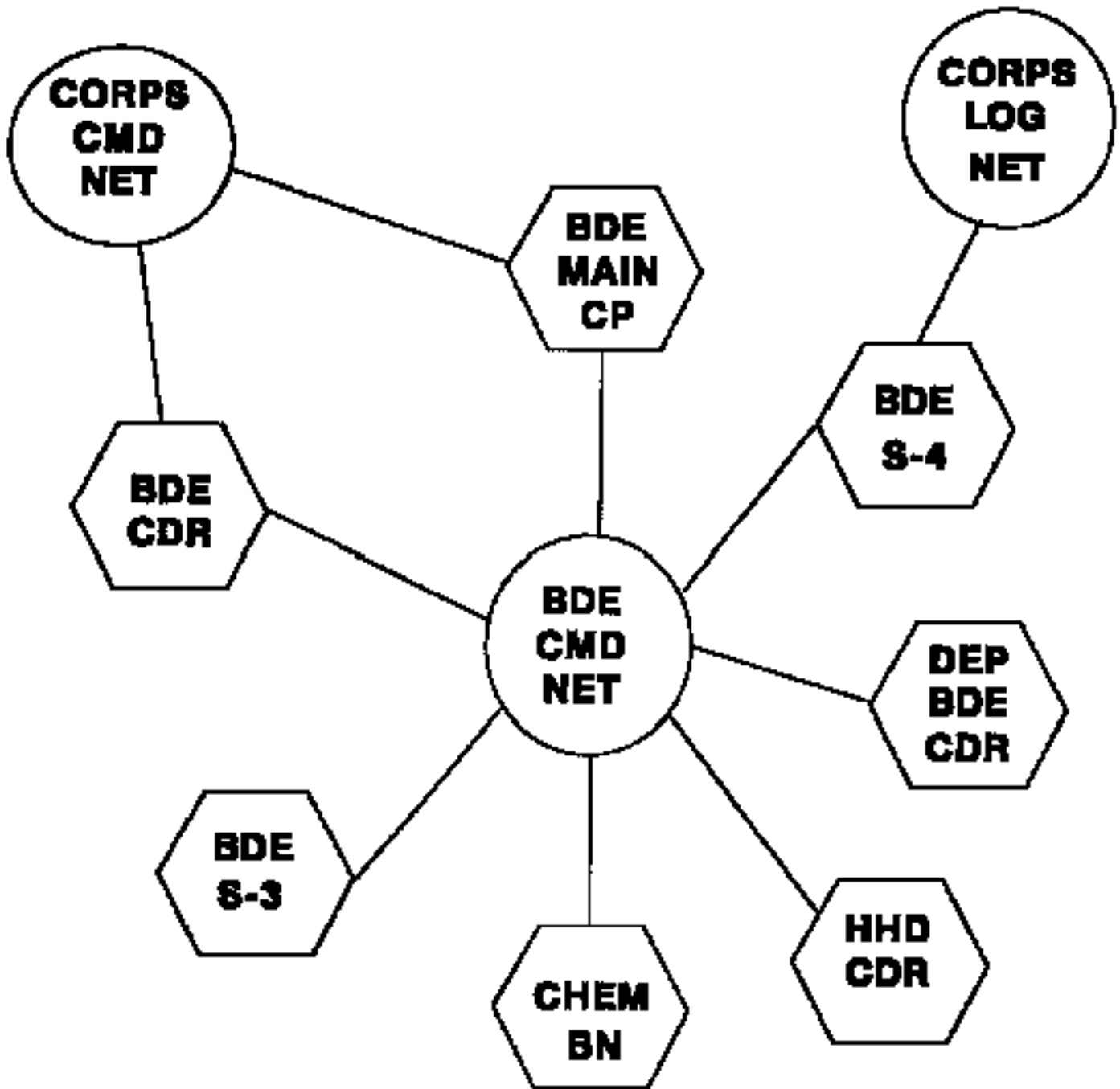
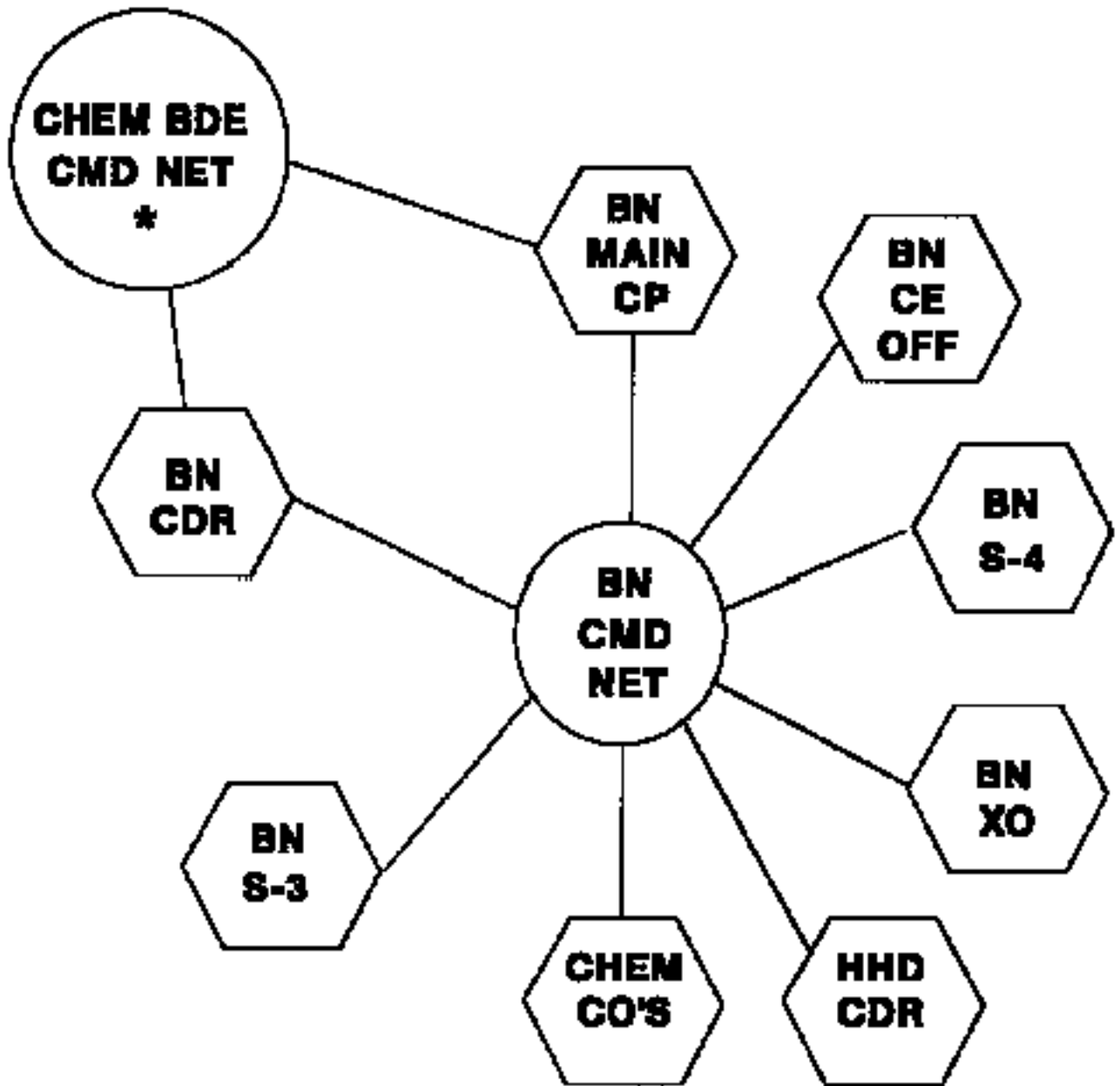

Figure 4-1. Radio net diagram (FM) for a chemical brigade HHD.



**\* or SUPPORTED UNIT CMD NET**

Figure 4-2. Radio net diagram (FM) for a chemical battalion HHD.

## COMMAND POSTS

## CHEMICAL BRIGADE

The chemical brigade tactical operations center (TOC) has three sections: S2/S3, S1/S4, and briefing tent ([Figure 4-3](#)). Modular frame



tents are used for the S2/S3 and S1/S4 sections.

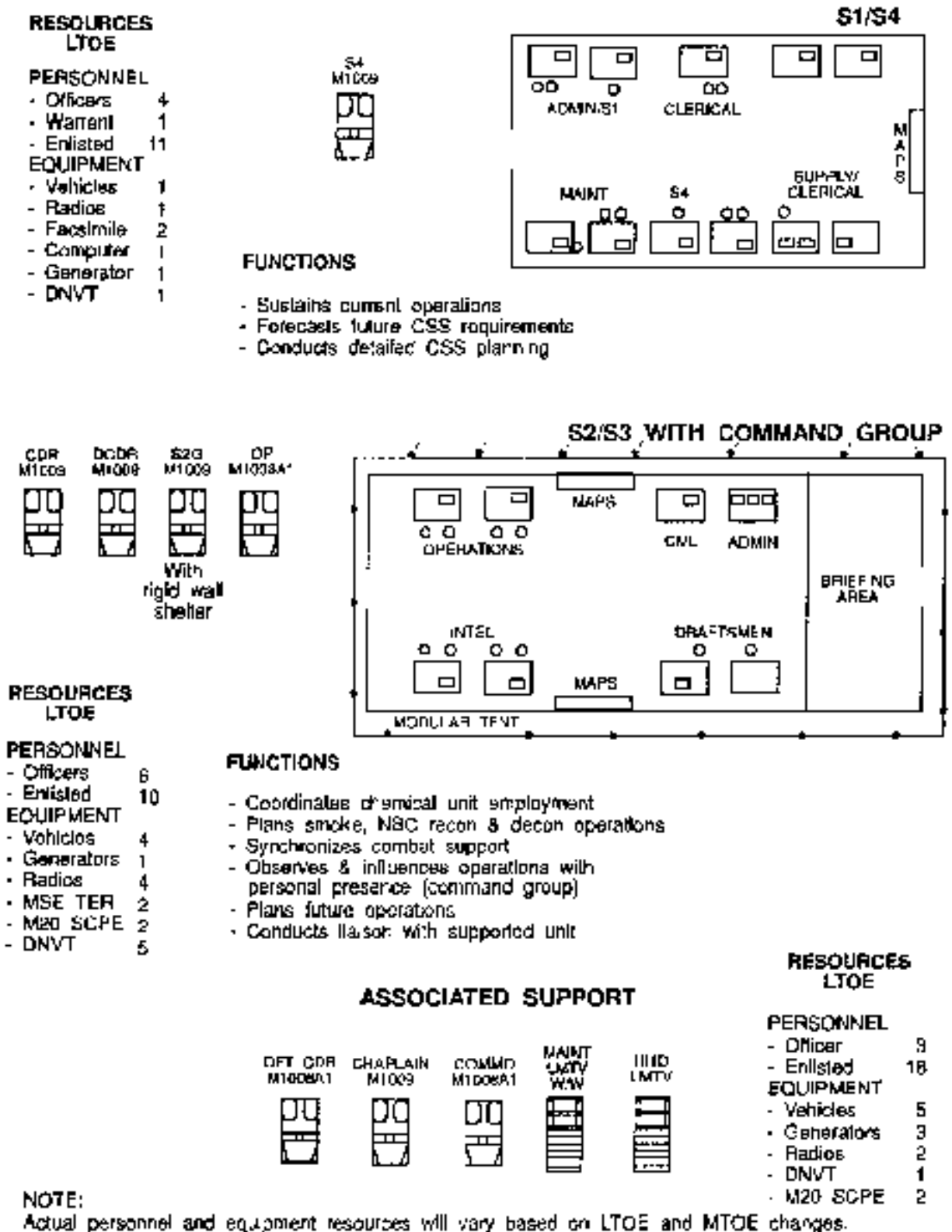
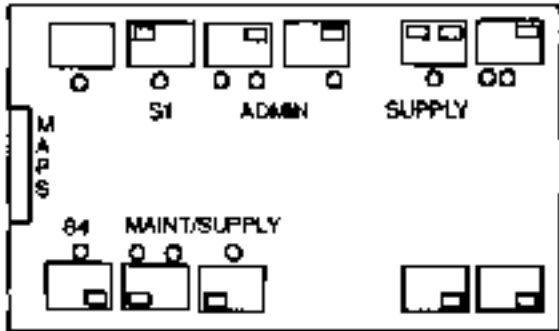

Figure 4-3. Chemical brigade TOC layout.

## CHEMICAL BATTALION

The chemical battalion tactical operations center (TOC) has two sections: S2/S3 and S1/S4 (Figure 4-4). Modular frame tents are used for the S2/S3 and S1/S4 sections.

**S1/S4**



**RESOURCES**

- LTOE**
- PERSONNEL**
- Officers 3
  - Warrant 1
  - Enlisted 11
- EQUIPMENT**
- Vehicles 3
  - Radios 1
  - Facsimile 1

**FUNCTIONS**

- Sustains current operations
- Forecasts future CSS requirements
- Conducts detailed CSS planning

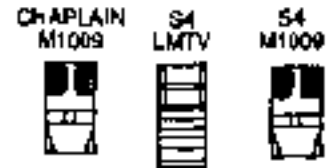

**S2/S3 WITH COMMAND GROUP**

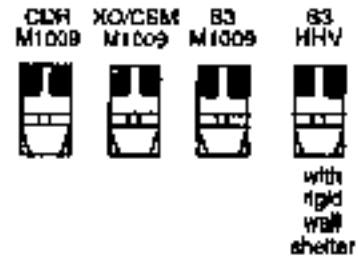
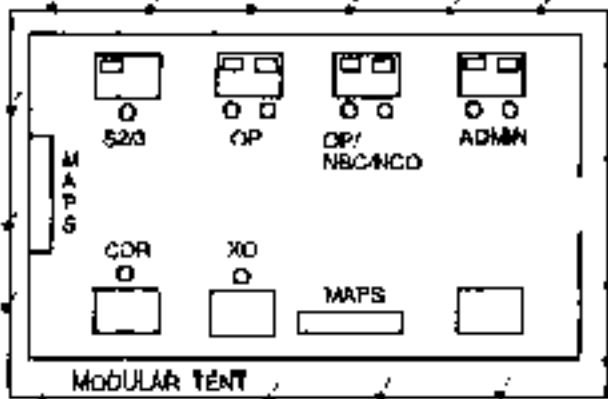

**RESOURCES**

- LTOE**
- PERSONNEL**
- Officers 4
  - Enlisted 8
- EQUIPMENT**
- Vehicles 5
  - Generators 1
  - Radios 4
  - MSE TER 3
  - Collective Protection System 2
  - DNVT 5

**FUNCTIONS**

- Coordinates chemical unit employment
- Plans smoke, NBC recon, & decon operations
- Synchronizes combat support
- Observes & influences operations with personal presence
- Plans future operations
- Conducts liaison with supported unit

**RESOURCES**

- LTOE**
- PERSONNEL**
- Officer 3
  - Enlisted 15
- EQUIPMENT**
- Vehicles 4
  - Generators 3
  - Radios 2
  - Collective Protection System 1

**ASSOCIATED SUPPORT**

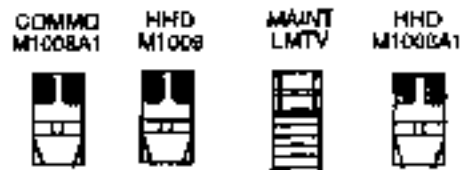

**NOTE:**

Actual personnel and equipment resources will vary based on LTOE and MTOE changes.

Actual personnel and equipment resources will vary based on LTOE and MTOE changes.

Figure 4-4. Chemical battalion TOC layout.

## CHEMICAL COMPANY

Company level organizations do not establish tactical operations centers. Companies establish command posts. Mechanized smoke companies are equipped with M577 armored command post vehicles. Other chemical companies set up their command posts using tents.

Company CPs are the focal point of all tactical and logistical planning and execution in the company. The company commander may operate from this CP if his platoons are widely dispersed and are not directly under his control. If he is in direct control of his subordinate platoon, the commander must select the best location for controlling his elements.

[RDL](#)[Table of](#)[Document](#)[Download](#)[Homepage](#) [Contents](#) [Information](#) [Instructions](#)

---

## CHAPTER FIVE

# CHEMICAL STAFF'S AND UNIT'S ROLES IN FORCE PROJECTION

The ability to project power is a central element of the nation's security strategy and force projection is a key element. Force projection may be deliberate or time sensitive. The Army's response to a regional crisis may be time sensitive and may occur in areas of the world where the Army does not have a significant presence. With the proliferation of weapons of mass destruction, it is likely that regional crises will involve nations that have an offensive NBC capability.

## FORCE PROJECTION ACROSS THE RANGE OF MILITARY OPERATIONS

The Army operates in a strategic environment that can result in military operations under many conditions. These operations are conducted within a range of three states--peacetime, conflict, and war. Force projection will usually begin as a contingency operation--a rapid response to a crisis. Contingency operations may be required for combat or noncombat situations. Contingency operations will be joint and could be combined. Committed forces are tailored and task-organized for rapid deployment, forcible entry if needed, effective employment, and mission accomplishment.

As weapons of mass destruction spread across the globe, it is likely that the US will face them in military operations across the range of military operations. Since NBC weapons will make any operation more difficult, detailed planning is crucial. Chemical units and staffs must be prepared to operate across the range of military operations and will play an increasing role in contingency operations. [Chapter 6](#) discusses operations other than war.

## **PHASES**

Ideally force projection operations are phased. While particular crisis response may not include every phase, there are generally eight phases to a force projection operation--

- Mobilization (if necessary)
- Predeployment activities.
- Deployment.
- Entry operations.
- Operations.
- Postconflict or postcrisis operations.
- Redeployment.
- Demobilization.

## **Mobilization**

In this phase, the active component is augmented by the reserve component. The amount and type of reserve forces mobilized depends on the crisis. A significant portion of the Chemical Corps force structure is maintained in the reserve component.

## **Chemical Units**

Reserve component chemical units may be mobilized as part of the deploying force. Active component chemical units may be assigned the responsibility of assisting mobilized units prepare for deployment. This includes assisting in the organizing of personnel, material, and supplies and certifying the proficiency of individuals and units.

## **Chemical Staff Considerations**

- Determine training requirements.
- Identify equipment and personnel shortages.

## **Predeployment Activities**

During this phase, military forces are selected and a force is tailored for deployment to meet the needs of the crisis. The type of crisis will dictate if chemical staffs and units are involved. Intelligence concerning the threat's capability to employ NBC or the type of commercial chemical hazards in the area of operations is critical to properly tailor the force.

## **Chemical Units**

Selected chemical units are alerted. Units recall and assemble personnel, then upload equipment and prepare for movement to the marshaling area. The amount of time the unit has available may be limited. Thus, premobilization training and preparation is critical. Units must review their load plans and deployment plans to ensure that all mission-essential equipment deploys with the unit. Review mission essential task list (METL) and develop a training program to correct identified deficiencies as time permits.

## **Chemical Staff Considerations**

- Determine possible NBC threat to include nonstandard hazards (commercial chemical and nuclear facilities).
- Identify chemical units needed to support the operation.
- Determine NBC defense training requirements.
- Plan early deployment of chemical command and control elements into the area of operations.
- Determine required CDE/NBC equipment.

## **Deployment**

During this phase of the operation the force actually deploys to the area of operations. During peacetime, deployment will normally be to the host nation directly by air or sea movement. In operations conducted during hostilities operations other than war, or war, occupation and expansion of the lodgement areas may require a forced entry and immediate combat operations. If the threat has the capability of employing NBC weapons, the use of these weapons during this phase may provide him with the greatest payoff against US forces. Combat forces and supporting forces will be sequenced into the area of operations to gain and sustain the initiative while protecting the force.

## **Chemical Units**

A tailored chemical force consisting of smoke/decon and NBC reconnaissance elements should be considered for early deployment if the threat warrants. If the threat has no offensive NBC capability, smoke/decon units could deploy without their decon equipment to minimize transportation requirements.

## **Chemical Staff Considerations**

- Determine host nation capabilities and coordinate for support.
- Monitor deployment of chemical units.
- Monitor deployment of NBC defense equipment.
- Monitor NBC situation and recommend changes to the plan as necessary.

## **Entry Operations**

The requirements for entry operations following deployment will vary with each operation. Whenever possible, unopposed entry is favored. Here deploying units flow through air or sea ports into lodgement areas. Typically entry operations during operations other than war will be unopposed. An opposed entry requires combat to land the deploying forces in the theater. The vulnerability of entry forces to weapons of mass destruction are acute during the initial entry stage. Force protection is critical. Chemical staffs and units will play a

key role in providing force protection.

The objective during this phase is to rapidly build the capability of the force in the area of operations. Proper sequencing of forces into the area will contribute to the stabilization of the situation and allow the commander to conduct decisive operations as early as possible. Combat may or may not occur. In either case the emphasis is on developing the preconditions for executing decisive operations,

Principal tasks during this phase include--establishing a forward operating base, closing the force, expanding the lodgement, linking up with other forces, securing the lodgement by expanding the security area, and striking out to engage enemy forces in offensive operations. If the enemy has NBC weapons, a minimal decon capability needs to be available. Smoke elements provide force protection with large-area smoke.

## **Chemical Units**

Protection of the force is the primary mission. Smoke units can provide large area screens over vital areas or as part of a deception operation. NBC recon units are positioned to react to any report of NBC hazards or attacks. Decon units are prepared to rapidly decontaminate contaminated units or facilities. terrain decon of vital areas, such as ports or air field may be necessary.

## **Chemical Staff Considerations**

- Determine host nation capabilities and coordinate for support.
- Monitor deployment of chemical units,
- Monitor deployment of NBC defense equipment.
- Monitor NBC situation and recommend changes to the plan as necessary.

## **Operations**

During this phase, the commander synchronizes elements of power to successfully conclude the contingency. In operations involving combat,



chemical units and staffs will perform their normal combat support roles. In peacetime engagement, the force completes its mission. If the enemy has an offensive NBC capability, it will likely be used during this phase. [Chapters 7 and 8](#) discuss support during offensive and defensive operations in detail, while [chapter 6](#) discusses operations other than war.

## **Chemical Units**

During this phase chemical units establish themselves in the theater. Early deployed chemical elements will support combat forces with smoke, decon, NBC staff, and NBC recon support as necessary. Decon sites will be identified and prepared. If time permits, conduct training to correct any deficiencies. Chemical units will provide support to the force as required.

## **Chemical Staff Considerations**

- Identify the NBC threat.
- Determine if current chemical force is sufficient.
- Monitor the status of NBC defense equipment in the theater.
- Monitor the status of NBC preparedness in the force.
- Develop training plans to correct NBC defense training deficiencies.
- Develop chemical support plans to support current operations.
- Develop NBC defense plans to protect the force.
- Monitor the NBC situation.
- Monitor the status of chemical units.
- Recommend changes to the plan based on NBC situation.
- Coordinate with host nation for support as necessary.

## Postconflict/Postcrisis Operations

The objective in this phase is to identify post-crisis and post-conflict requirements as early as possible. Units and assets no longer required are redeployed. Depending on the NBC situation, chemical units may be required to remain in the area of operations longer than other forces.

### **Chemical Units**

Chemical units may remain in the area of operations to identify areas of contamination, locate NBC weapon storage sites, provide decon support, or perform other tasks and missions. A command and control element needs to be present until all chemical units have redeployed. Once the units have redeployed, they must quickly prepare for possible future missions.

### **Chemical Staff Considerations**

- Assist the commander in determining post-crisis and post-conflict chemical support requirements.
- Provide technical advice on the handling and disposal of captured NBC munitions.
- Gather NBC technical intelligence.
- Coordinate chemical support requirements and recommend support priorities to the commander.
- Coordinate with host nation for support.
- Monitor the redeployment of chemical units.

### Redeployment

During this stage, units that are no longer required are redeployed. Chemical assets may be required to remain in the area of operations to provide support. Captured NBC weapons and NBC defense equipment must be properly handled and disposed of. Decon units may be required to

perform thorough decon operations to allow for the retrograde of equipment that was contaminated during operations. Peacetime and wartime acceptable exposure levels vary and federal laws must be followed.

## **Demobilization**

Reserve component units are transferred from active status to reserve status. The demobilization of NBC Logistical material and supplies is also part of this operation. During this phase, units must conduct after action reviews and prepare written summaries of their observations. By documenting what went right and what went wrong, lessons learned can be developed.

## **CONSIDERATIONS**

### **DURATION**

The type of crisis will determine the duration of the operation. Chemical units and staffs must be prepared for sustained operations. Supply and maintenance support requirements must be included in the initial planning stages.

### **FORCE TAILORING**

Force tailoring configures forces for the mission. The force must be appropriate and based on METT-T, lift capability, pre-positioned assets, and host nation support. Contingency operations require forces tailored for the specific crisis. The type of force and the NBC threat will dictate the required chemical support. Chemical command and control elements are allocated based on the number and type of subordinate elements. A chemical company headquarters is allocated if two or more chemical platoons deploy. A chemical battalion HHD deploys if there are two or more nondivisional chemical companies in the force. A brigade chemical HHC deploys if there are two or more chemical battalions in the force.

### **TASK ORGANIZATION**

Task organization is the process of forming task forces. The composition is determined by the situation and the available

transportation assets. Chemical company teams may be formed to provide the necessary chemical support with a controlling headquarters.

## **INTELLIGENCE**

Accurate, timely, and detailed intelligence is critical during contingency operations. Chemical staffs must determine the enemy's offensive NBC capability. Additionally, potential commercial NBC hazards should be assessed.

## **LOGISTICS**

NBC defense equipment places a great burden on the logistics system. Chemical staff officers must advise the commander when to initiate MOPP along with a risk assessment. Coordinate logistics support for the chemical units in the area of operations.

## **BATTLE COMMAND**

Chemical command and control elements deploy early during the operation. They can lessen the burden on the chemical staffs.

[RDL](#)[Table of](#)[Document](#)[Download](#)[Homepage](#) [Contents](#) [Information](#) [Instructions](#)

---

## CHAPTER SIX

# OPERATIONS OTHER THAN WAR

## OVERVIEW

Operations other than war include those operations conducted during peacetime and conflict short of war. It is also possible that these type of operations can be conducted during war as an adjunct to the main effort.

### PEACETIME

Contingency operations here normally focus on assisting US, allied, or friendly nation civil authorities to cope with natural or man-made disasters. Typical missions are--

- Humanitarian assistance and disaster relief.
- Arms control/treaty verification.
- Support to domestic civil authorities.

### CONFLICT

Here, contingency operations are usually time-sensitive military operations characterized by rapid power projection of combat forces. These operations include--

- Counterterrorism.
- Security assistance.
- Humanitarian assistance.

- Counter-drug.
- Peacekeeping.
- Strikes and raids.
- Noncombatant evacuation.
- Support to insurgency or counterinsurgency
- Support to domestic civil authority.

## **COUNTER-TERRORISM**

In the past, terrorist groups have attempted to obtain chemical weapons. As the proliferation of NBC weapons spreads, this possibility increases. Chemical staffs and units will support counter-terrorist operations by providing NBC defense training to key individuals. Special forces NBC reconnaissance detachments can conduct special reconnaissance operations to locate terrorist NBC storage sites and/or manufacturing facilities. Chemical units and staffs can provide technical advice and assistance once terrorists have used NBC weapons.

Chemical units and staffs operating in areas where there is a high terrorist threat must take terrorist countermeasures. Soldiers should be trained in common-sense terrorism countermeasures. [FM 100-37](#), *Terrorism Counteraction*, provides guidance on unit countermeasures.

## **SECURITY ASSISTANCE**

During the Gulf War, chemical personnel provided security assistance to friendly and allied nations. This assistance involved training of their military forces in NBC defense techniques. Both chemical staffs and units can provide security assistance support. The Security Assistance Training Program (SATP) has two components - International Military Education and Training Program (IMETP) and foreign military sale program (FMSP) training. The objectives of these programs are--

- Develop skills required to operate and maintain acquired US equipment.

- Develop a foreign country's expertise in effective management of its defense establishment.
- Foster development of a foreign country's professional and technical training capability.
- Promote US military rapport with counterparts in a foreign country.
- Promote a better understanding of the US, its people, political system, institutions, and way of life.
- Increase the awareness of international military personnel on the US commitment to human rights.

IMETP is designed to advance the efficiency, professional performance, and readiness of the recipient armed forces. This training is normally conducted in CONUS, but can occur in other countries. The methods of training vary; formal courses, orientation tours, and on-the-job training are several methods.

FMSP allows eligible foreign governments to purchase defense equipment, services, and training from the US. Training on the maintenance and operation of the equipment is accomplished by two methods--mobile training teams (MTT) or field training services (FTS). MTTs are military personnel on temporary duty to train foreign personnel. The team's size and composition are based on the request submitted by the host nation. The objective of the training is to develop an institutional base with the host nation so that they can then train themselves. FTS is a long-term MTT that can consist of military or civilian employees or contract personnel.

## **HUMANITARIAN ASSISTANCE**

These operations provide emergency assistance to victims of natural or man-made disasters abroad. Chemical staffs and units provide specialized assistance in chemical- or nuclear-related disasters. This can include monitoring and survey, detection and identification of hazards, and decontamination. In disasters not involving chemical or nuclear hazards, chemical units can provide general support. This support includes providing showers, off-the-road water haul, and

limited firefighting capability.

## **COUNTER-DRUG OPERATIONS**

Chemical staff personnel can provide technical expertise to military units involved in counter-drug operations. The manufacturers of illegal drugs use and produce many dangerous chemical compounds. Chemical corps personnel can provide technical advice in the handling and disposal of dangerous chemical materials.

Chemical personnel can provide advice on the destruction of drug labs and related materials using flame field expedients or using defoliants to destroy drug crops.

## **PEACEKEEPING OPERATIONS**

Peacekeeping forces deployed in countries that possess NBC weapons will require support from both chemical staffs and units. Chemical staff officers and NCOs need to be included at all echelons within the military peacekeeping command. A senior chemical staff officer with a broad range of expertise needs to be included on the staff of the military peacekeeping command. This command exerts overall control of the peacekeeping forces and is normally multinational. The military peacekeeping force commander exercises operational control of the subordinate military forces. Under the military peacekeeping command are military area commands. The military area commands usually consist of a single nation's military force and operates in a specific geographical area.

Chemical staffs organic to the military organizations deployed in a peacekeeping role will provide NBC staff support to their organizations. If the military unit does not have a chemical staff, then the organization should be augmented with a JA or JB team. Ad hoc chemical staffs also can be formed. Depending on the situation and the NBC threat involved, chemical units maybe deployed. The organization and type of chemical support package is dependent on METT-T. At a minimum, a chemical company team should be deployed to provide the necessary C<sup>2</sup> and logistical support.

## **ARMS CONTROL/TREATY VERIFICATION**



Arms control focuses on promoting strategic military stability. Chemical staff personnel provide technical assistance on monitoring the proliferation of NBC weapons and technology. Chemical officers occupy staff positions in agencies responsible for nuclear and chemical weapons treaty verification. Chemical units and organizations are involved in the demilitarization of chemical munitions and associated equipment.

## **STRIKES AND RAIDS**

Strikes are attacks by ground, air, and naval forces to damage or destroy high value targets or to demonstrate our capability to do so. These operations involve the swift penetration of hostile territory to secure information, seize an objective, or destroy targets and end with a planned withdrawal. The execution of this type of contingency operation contains many of the missions discussed in [Chapters 7, 8, and 9](#).

## **NONCOMBATANT EVACUATION OPERATIONS**

This type of operation is conducted when the situation in a country requires the evacuation or relocation of US citizens, selected host nation personnel, and third country nationals. The operation may take place in a low threat environment or require combat action. Chemical staff personnel will be involved if the host nation possesses an NBC capability. Additionally, chemical personnel can provide expertise on the employment of riot control agents (RCA).

## **SUPPORT TO INSURGENCY OR COUNTERINSURGENCY**

Insurgencies are organized movements to overthrow a constituted government through the use of subversion and armed conflict. The National Command Authority (NCA) may direct US forces to assist either insurgent movements or host nation governments opposing an insurgency. Chemical staff personnel can provide expertise on the use of RCA, flame weapons and commercial chemical threats. As the proliferation of NBC weapons spreads across the globe, it is possible that forces involved in insurgent/counterinsurgent operations could see the use of chemical weapons. Smoke units could provide smoke screens to obscure friendly activities from hostile forces.

## SUPPORT TO DOMESTIC CIVIL AUTHORITY

Support to US civil authority are those activities carried out by the military in support of Federal and state officials. These activities are limited by the Posse Comitatus Act. Support provided by chemical units can include disaster assistance, civil disturbance control, and hazard materials response. Decontamination units can provide an off-the-road water haul capability, fire fighting support, and decontamination of hazardous spills. Chemical units can provide expertise on the employment of RCA during civil disturbance control operations. See [FM 100-19](#), *Domestic Support Operations* for more detail.



[RDL](#) [Table of](#) [Document](#) [Download](#)

[Homepage](#) [Contents](#) [Information](#) [Instructions](#)

---

## CHAPTER SEVEN

# OFFENSIVE OPERATIONS

The offense is the decisive form of combat. To win battles, friendly forces must move fast, strike hard, and finish rapidly. Under NBC conditions, attacking forces must use NBC defensive principles-- avoidance, protection, and decontamination--to preserve combat power; and use smoke to enhance combat power. The offensive framework consists of--

- A main attack with supporting attacks as required.
- Reserve operations in support of the attack.
- A reconnaissance and security operation forward and to the flanks and rear of main and supporting attacks.
- A continuous deep operation in vital parts of the zone of attack.
- Rear area operations necessary to maintain offensive momentum.

Chemical units are integrated throughout the battlefield. NBC reconnaissance elements detect contamination along routes of advance and monitor lines of communications. Smoke units provide large area screens to conceal the breaching of obstacles and the disposition and intentions of friendly forces. Decontamination units assist in the regeneration of combat power when contamination avoidance was not possible.

## MOVEMENT TO CONTACT

Movement to contact is an operation to gain or reestablish enemy contact. Neither side may clearly have the initiative. Versatility is key when planning and executing a movement to contact. By maintaining

versatility, the commander's freedom of action is retained once enemy contact is made. During a movement to contact, protection of the force has first priority. This is achieved by applying the principles of NBC defense and using obscurants for concealment and deception.

Corps and divisions normally organize into a covering force, advance guard, and a main body. The covering force operates at extended distances from the main body and must be self contained. The advanced guard is the security force provided by the main body. It operates forward of the main body to protect it from surprise attack and protects the main body when committed. The main body is the force task-organized and prepared for immediate action upon enemy contact.

## **CHEMICAL BRIGADE**

The chemical brigade provides NBC reconnaissance and smoke assets to the covering force. Since the covering force will be operating well forward of the corps' main body, these assets should be attached to the unit operating as the covering force. The remainder of the brigade should be task-organized based upon METT-T. The command and support relationships of these task-organized chemical units are determined on the ability of the brigade headquarters to provide command and control and to coordinate CSS support. The brigade headquarters should move with the main body and when stationary, sets up near the corps main CP.

## **CHEMICAL BATTALION**

The organization and positioning of the chemical battalions is based upon METT-T and the ability of the chemical brigade to provide C<sup>2</sup>. If a division is the covering force, a chemical battalion that is NBC reconnaissance and smoke heavy should be attached. The battalion should have CSS support from the COSCOM and provide chemical unit support to the covering force based on METT-T. The chemical battalion CP should be positioned near the division main CP with liaison provided to the division TAC.

Chemical battalions not supporting the covering force are task-organized based on METT-T and are positioned in the main body. Since there is a need for continuous and rapid movement, these battalions should move behind their supported elements. A DS role may be the best to provide the supported unit with rapid and flexible support. A minimal amount of resupply from the COSCOM will be available except for

refueling.

## **CHEMICAL COMPANIES**

The priority of support will be to the lead maneuver units with NBC recon and smoke support. Task organization of the chemical companies will be based upon METT-T with consideration given to the ability of the higher headquarters to provide C<sup>2</sup> and CSS. Decon units should be prepared to conduct operational decon to maintain momentum.

Consider forming chemical company teams to provide more flexible and responsive support. Chemical companies should not be given area support missions, but tasked to support specific units.

## **CHEMICAL STAFF CONSIDERATIONS**

- Focus NBC defense operations to provide the commander flexibility.
- Conduct operational decon as necessary.
- Plan thorough decon after the mission.
- Select decon sites along the axis of advance.
- Identify known or suspected areas of contamination.
- Provide smoke assets to maneuver forces to best support the mission for deliberate smoke.
- Priority of NBC recon and smoke support to lead maneuver forces based on mission and NBC threat.
- Balance vulnerability of the force against the need for mass and agility.

## **HASTY AND DELIBERATE ATTACK**

Attacks may be launched from a movement to contact, from a defensive posture, from behind a friendly defending force or during exploitation or pursuit. There are two basic types: deliberate and hasty. The two are distinguished by the extent of preparation. In either case,

chemical units will be employed to enhance maneuver and firepower of the attacking force. Additionally protection of the force remains a high priority. NBC reconnaissance units should be employed to avoid contaminated areas. Obscurants are used to degrade enemy target acquisition and conceal movement of friendly forces. Decon is conducted as necessary to generate combat power.

Hasty attacks are not planned in detail. This type of attack is usually initiated by a fragmentary order. Forces will deploy, rapidly maneuver, and attack quickly and violently to gain the initiative. Chemical unit support must be responsive and flexible.

## **CHEMICAL BRIGADE**

The chemical brigade provides NBC reconnaissance and smoke assets to support the corps' scheme of maneuver. Priority of support is given to the corps main effort. The command and support relationships of these task-organized chemical units are determined by the ability of the brigade headquarters to provide command and control and to coordinate CSS support. The brigade headquarters establishes its CP near the corps main TOC.

## **CHEMICAL BATTALION**

The composition of the chemical battalion is based on METT-T. A battalion headquarters will command and control three to seven chemical companies. Normally, a chemical battalion will be allocated to support the division designated as the corps main effort. The command and support relationship between the battalion and the division is based on the chemical brigade's ability to provide command and control and the logistic support available from the corps and division. Other chemical battalions will provide support with priority to the supporting attack and the rear area.

## **CHEMICAL COMPANIES**

The division chemical company should be task-organized based upon METT-T. If there is a high threat of chemical attacks, it is likely that each maneuver brigade would be supported by a decon platoon. The smoke platoon would support the brigade conducting the main effort and the NBC recon platoon could operate in three squads of two vehicles, each supporting a maneuver brigade. The remaining decon platoon would

operate in a GS role supporting the units in the division rear. Additionally, this GS decon platoon could reinforce another decon platoon if a significant portion of the force was contaminated.

In the division being supported by a chemical battalion, it is possible to form chemical company teams organized to support specific areas or subordinate commands.

## **CHEMICAL STAFF CONSIDERATIONS**

- Focus NBC defense operations to provide the commander flexibility and facilitate synchronization.
- Conduct operational decon as necessary.
- Plan thorough decon after the mission is completed.
- Select decon sites throughout the zone.
- Operate in the lowest possible MOPP level.
- Identify known or suspected areas of contamination.
- Focus NBC reconnaissance assets to retain freedom of maneuver.
- Use smoke to conceal movement of forces in zone and obstacle breaching.
- Prioritize of NBC recon and smoke support to lead maneuver forces.
- Balance vulnerability of the force against the need for mass and speed.
- Identify possible contaminated areas and possible by-pass routes (for example, by-pass to the north).
- The possibility of enemy NBC attacks increases as the attack progresses.
- Consider the impact of enemy flame weapons.

## **EXPLOITATION AND PURSUIT OPERATIONS**

Exploitation and pursuit operations begin immediately from the attack. Exploitation is the bold continuation of an attack following initial success. Pursuit is the relentless destruction of fleeing enemy forces who no longer have the capability to resist.

Fleeing enemy forces may use chemical weapons more freely than an enemy executing a well-prepared defense. This will necessitate the employment of NBC reconnaissance units. Obscurants are used to increase survivability. Decon operations are conducted as necessary to regenerate combat power.

### **CHEMICAL BRIGADE**

The brigade will provide chemical units, especially smoke and NBC reconnaissance, to the units conducting the exploitation. These supporting chemical units need to be as mobile and self-sustaining as possible. Since the exploitation force will move continually over long distances, the command and support relationship of this chemical force should be attached or OPCON. The brigade CP should be established where it can best provide command and control of its subordinate elements and coordinate future operations with the corps.

### **CHEMICAL BATTALION**

A chemical battalion that is smoke and NBC recon heavy should be allocated to the division conducting the exploitation. The command and support relationship between this battalion and the division is based on the ability of the brigade to provide C<sup>2</sup> and coordinate CSS. The other battalions can operate in support of the other division or have area responsibilities. These battalions should have a mix of smoke, decon, and NBC recon units. Battalions having area responsibilities in the corps rear should be decon heavy.

### **CHEMICAL COMPANIES**

The division chemical company will be task-organized based upon METT-T. If there is a high threat of chemical attacks, it is likely that each maneuver brigade would be supported by a decon platoon. The smoke platoon would support the brigade conducting the main effort and the



NBC recon platoon could operate in three sections of two vehicles, each supporting a maneuver brigade. The remaining decon platoon would operate in a GS role supporting the units in the division rear. Additionally, this GS decon platoon could be pushed forward to reinforce another decon platoon if a significant portion of the force was contaminated.

In the division being supported by a chemical battalion, it is possible to form chemical company teams. These company teams are organized to support specific areas or subordinate commands.

## **CHEMICAL STAFF CONSIDERATIONS**

- Focus NBC defense operations to provide the commander flexibility and speed.
- Ensure NBC support is agile and flexible.
- Conduct operational decon only as necessary.
- Plan thorough decon after the mission.
- Select decon sites along routes of friendly maneuver to increase the survivability of the decon operations.
- Operate in the lowest possible MOPP level.
- Mark and report all identified areas of contamination and control access into those areas.
- Be prepared to encounter enemy stockpiles of NBC weapons.
- Be prepared to encounter the effects of destroying enemy NBC weapons stockpiles, facilities, and commercial chemical/nuclear facilities.
- Consider the increased probability of enemy NBC attacks as he attempts to break contact and regain the initiative.
- Focus NBC recon assets to retain freedom of maneuver.

- Provide smoke assets to lead maneuver forces.
- Priority of NBC recon and smoke support to lead maneuver forces.
- Balance vulnerability of the force against the need for mass and speed.
- Ensure chemical units are able to maintain pace with the supported forces.
- Plan decon sites in coordination with the unit conducting the mission.

## **OTHER OFFENSIVE OPERATIONS**

### **RIVER CROSSING OPERATIONS**

River crossings are conducted as part of a division or corps scheme of maneuver. There are two types of river crossings: deliberate and hasty. The size of the river, as well as the enemy and friendly situation, will dictate the crossing technique. Deliberate river crossings require detailed planning and coordination, a buildup of firepower, and centralized command and control. Hasty river crossings use expedient means and are conducted with minimal planning.

River crossing operations present lucrative targets for enemy NBC weapons. Large-area smoke support is necessary to conceal the actual and deception crossing sites. Decon units are prepared to conduct operational decon operations to ensure the momentum of the crossing is not lost. NBC recon units are employed in a contamination avoidance role on the far side to allow the momentum of the operation to continue. Additionally, NBC recon units are prepared to respond to NBC attacks in the crossing areas.

### **Chemical Brigade**

The brigade will provide chemical units to support the crossing operations. These units will be under the control of the crossing force commander. The crossing force may require a mixture of smoke, NBC recon, and decon elements. If this is a corps level operation, the brigade establishes a liaison element at the crossing force

headquarters. If this is a division level operation, the brigade allocates a command and control element to assist the division crossing force commander in controlling the supporting chemical units. The brigade CP should be established where it can best provide command and control of its subordinate elements and coordinate future operations with the corps.

## **Chemical Battalion**

The chemical battalions are task-organized to support the crossing area and are prepared to support units on the far side. The battalions can support a specific units or given area support missions. The battalion supporting combat units should be smoke heavy. The battalions given area support missions should have a balanced mix of chemical companies (decon, mech smoke, motor smoke, and recon).

## **Chemical Companies**

Use smoke or smoke heavy teams to support the crossing area. These companies position their headquarters so they can best control operations and communicate with the crossing site headquarters or supporting chemical battalion headquarters.

Decon sites are established near the crossing sites, but not to interfere with crossing operations. The decon sites should be located out of enemy artillery range.

Position NBC recon elements to support the crossing sites and the routes to them. NBC recon elements cross with the lead maneuver force find clear routes around contaminated areas on the far side.

Position smoke elements to support the crossing sites and start smoke prior to any engineer work. Use a haze so as not to interfere with the engineer effort. Smoke units should ensure they are positioned to be resupplied as well as to support the mission. Smoke units will consume large quantities of fog oil and POL. Consider propositioning fog oil near the crossing sites.

## **Chemical Staff Considerations**

- Focus NBC defense operations to provide the commander flexibility

and speed.

- Reduce vulnerability by dispersing forces and using multiple crossing sites.
- Conduct operational decon as necessary.
- Select decon sites to support the crossing sites.
- Operate in the lowest possible MOPP level.
- Consider the high probability of enemy NBC attacks.
- Focus NBC recon assets to retain freedom of maneuver in the crossing area.
- Prepare to shift NBC recon assets to the far side with the initial assault force.
- Plan for the use and distribution of smoke pots.
- Use a smoke haze on the crossing sites.
- Plan smoke in support of deception operations.
- Balance vulnerability of the force against the need for mass and speed.

## **RECONNAISSANCE IN FORCE**

A reconnaissance in force is a limited objective operation designed to--

- Obtain information.
- Test enemy dispositions, strengths, and reactions.

This operation is usually executed prior to and as part of an attack or during a movement to contact. The objective is to acquire information regarding the enemy's situation and identify or confirm weaknesses in his defense. Corps or smaller units can conduct this operation. The headquarters controlling the operation must have sufficient forces to

exploit success or extricate the committed force. The force must be capable of causing the enemy to react strongly and definitely to the attack, thus disclosing his locations, dispositions, strength, planned fires, and planned use of his reserves.

Since this is a limited objective operation, units contaminated will most likely continue to operate contaminated until after the mission. Smoke is employed to obscure friendly maneuver, degrade enemy target acquisition, and support deception operations. NBC recon elements move with the lead maneuver force to assist in finding clear routes if contamination is encountered.

## **Chemical Brigade**

The brigade may provide chemical units to support recon in force operations, dependent on METT-T. The size of the force and the scope of the operation will dictate the level of support that the brigade will provide. The command and support relationship is also dependent on METT-T. The force conducting the operation may require a mixture of smoke, NBC recon, and decon elements. If this is a corps level operation, the brigade establishes a liaison with the force conducting the operation. If this is a division-level operation, the brigade should allocate a command and control element to assist in controlling the supporting chemical units. The brigade CP should be established where it can best provide command and control of its subordinate elements and coordinate future operations with the corps.

## **Chemical Battalion**

The chemical battalion is task-organized to support the operation with a mix of chemical units, but heavy on smoke and NBC recon. The battalion headquarters should collocate near the force headquarters conducting the operation. Maximum flexibility should be given to the force commander in task-organizing supporting assets.

## **Chemical Companies**

If this operation is being conducted by a brigade-size force, the supporting chemical units should be controlled by a chemical company headquarters. It maybe necessary to forma chemical company team or reinforce an existing chemical company (in the case of an ACR performing this mission with its organic chemical company). The

supporting chemical company(s) position their headquarters so they can best control their operation(s) and communicate with their higher and supporting unit headquarters.

## Chemical Staff Considerations

- Focus NBC defense operations to provide the commander flexibility and speed.
- Ensure NBC support is agile and flexible.
- Conduct operational decon only as necessary.
- Plan thorough decon after the mission.
- Operate in the lowest possible MOPP level.
- Mark and report contamination.
- Focus NBC recon assets to retain freedom of maneuver.
- Provide smoke assets to lead maneuver forces.
- Consider the relative mobility of chemical units and the supported forces.

## **PASSAGE OF LINES**

A passage of lines is an operation in which one force moves through another force either to come into (forward) or to move out of (rearward) contact with the enemy.

A forward passage of lines a unit passes through another that is in contact with the enemy to continue the attack. On receipt of the warning order directing the passage of lines, the incoming unit establishes liaison with the unit in contact to begin detailed planning. The incoming unit normally collocates its TAC or main CP with the TAC or main CP of the unit in contact. The vulnerability to enemy NBC attacks increases because of the concentration of forces in the passage area. NBC recon elements are positioned at the passage points to assist if the passage lanes become contaminated. The unit in contact is

responsible for providing decon support to the incoming unit. Large area smoke support is coordinated between the unit in contact and the incoming unit. After responsibility for the zone of action or sector of defense is transferred, so is the responsibility for all smoke operations.

In a rearward passage of lines a unit affecting a retrograde movement (withdrawal) passes through the sector of a unit occupying a defensive position. The planning and coordination is identical with that of the forward passage. The withdrawing unit must have priority on an adequate number of roads and facilities to allow its rapid movement through the defended area. The vulnerability to enemy NBC attacks increases during the passage operation because of the concentration of forces. NBC recon elements are positioned by the defending unit at the passage points to assist if the passage lanes become contaminated. The defending unit is responsible for providing decon support. Passage of lines during a withdrawal requires decon points identified so as to minimize traffic congestion. Contaminated units may have to decon in assembly areas in the rear if sufficient vehicles are contaminated. Large-area smoke support is coordinated between the defending unit and the rearward moving unit. The defending unit would position and control all smoke units in their defensive sector.

## **Chemical Brigade**

The brigade will provide chemical units to support operations subsequent to the passage (that is, the defense and offensive or retrograde operations). Additional chemical resources could be allocated to support the passage operation based on METT-T (significant NBC threat at the passage area or the need for smoke because of limited cover and concealment in the passage area). These additional chemical elements will be under the control of the unit responsible for the passage. If this is a corps level operation, the brigade establishes a liaison element at the headquarters controlling the passage. If this is a division level operation, the brigade allocates a command and control element to assist. The brigade CP should be established to best provide command and control of its subordinate elements and coordinate future operations with the corps.

## **Chemical Battalion**

The chemical battalions are task-organized to support the divisions

subsequent to the passage and are prepared to provide support during the passage of lines. The battalions can be designated to support a specific unit or given area support missions.

## Chemical Companies

Organize chemical companies supporting a passage of lines as smoke and NBC recon heavy. Prepare for sustained smoke operations. Position their headquarters to best control operations and communicate with the headquarters controlling the passage and the supporting chemical battalion.

## Chemical Staff Considerations

- Focus NBC defense operations to provide the commander flexibility and synchronization.
- The stationary unit plans decon support for the moving force.
- Designate passage points and passage lanes for the contaminated elements.
- Exchange NBC information between the moving and stationary forces.
- Operate in the lowest possible MOPP level.
- Position NBC recon assets to support the passage operation.
- Conceal movement of forces during the passage.
- Use smoke to break contact with the enemy.
- Balance vulnerability against the need for mass and synchronization.
- Determine alternate routes in case the primary passage lanes become contaminated.
- Concentration of forces increase the possibility of enemy NBC attacks.



## SYNCHRONIZING OFFENSIVE OPERATIONS

This section provides an example of how chemical units could be synchronized to support an attack. The XX Corps' mission is to defeat a defending enemy combined arms army (CAA) weakened through previous engagements and occupying a hasty defense. The example will use the offensive framework and is only one example of a concept and should be treated as such. The corps portrayed consists of two armored divisions, two mechanized divisions, a separate armored brigade, an armored cavalry regiment, an aviation brigade, and the associated combat support and combat service support units. A chemical brigade with all the subordinate chemical units for this size force is present and available for employment ([Figure 7-1](#)). The Corps' defending enemy CAA has three motorized rifle divisions in the main defensive belt, one motorized rifle division in the second defensive belt, and a tank division in reserve behind the second defensive belt. The enemy has an extensive capability to use chemical weapons and a limited nuclear capability. He has used chemical weapons extensively during both defensive and offensive operations. No nuclear weapons have been used.

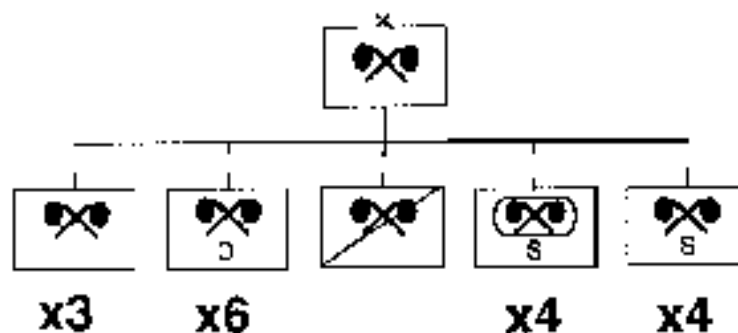

Figure 7-1. The chemical brigade supporting XX Corps.

### THE MISSION

The mission of the corps is to penetrate the defensive belts and allow a follow-on corps to pass through and defeat the CAA by exploitation. The commander's intent is initially to effect a penetration of both defensive belts, contain the defending CAA's forces, then pass the follow-on corps through. This will be followed by continued offensive operations to defeat the entire CAA defense.

## THE GENERAL SCHEME OF MANEUVER

The corps will conduct this operation in five phases ([Figure 7-2](#)).

Phase 1. Penetrate the first echelon motorized rifle division (MRD) on the left with the 52d Infantry Division (ID) (Mech). Once the first echelon MRD or the left is penetrated, penetrate the center MRD with the 54th ID. The 52d ID is the corps main effort.

Phase 2. Pass the 23d Armored Division through the penetration created by the 52d ID and conduct a feint with the 313th Armored Brigade (Sep) against the MRD on the right. The 23d AD attack is designed to cause the commitment of the enemy's reserve--the tank division. If the enemy does not react with its reserve, the 23d AD will continue to penetrate the second defensive belt and envelop the second echelon MRD. The feint is designed to fix the MRD on the right and prevent it from reacting to the attack on the center MRD.

Phase 3. This phase has two possible branches. The remaining armored division--25th Armored Division (AD) will pass through the 54d ID in the center. If the enemy reserve tank division has counterattacked against the 23d AD, the 25th AD will attack to destroy it and the 23d AD will continue its envelopment of the second echelon MRD.

Branch 1. If the tank division does not commit, the 25th AD will attack to cover the flank of the 23d AD from a possible counterattack by the tank division. Both armored divisions will then penetrate the left side of the second echelon MRD. The 23d AD will attack to envelop the tank division, while the 25th AD attacks to envelop the second echelon MRD.

Branch 2. If the tank division only moves to a defensive position on the left side of the second defensive belt to block the penetration of the 23d AD, the 25th AD will attack to penetrate, then envelop the right side of the second defensive belt. The 23d AD will attack to fix the tank division.

Phase 4. The 201st Armored Cavalry Regiment will pass through either penetration depending on the outcome of phase 3. The 201st ACR will attack to sever the combined arms army's (CAA) lines of communication (LOC) and destroy combat support and combat service support units in the CAA's rear area.

Phase 5. Pass the follow-on corps and continue combat operations to destroy the second echelon MRD and defeat the first echelon MRDs.

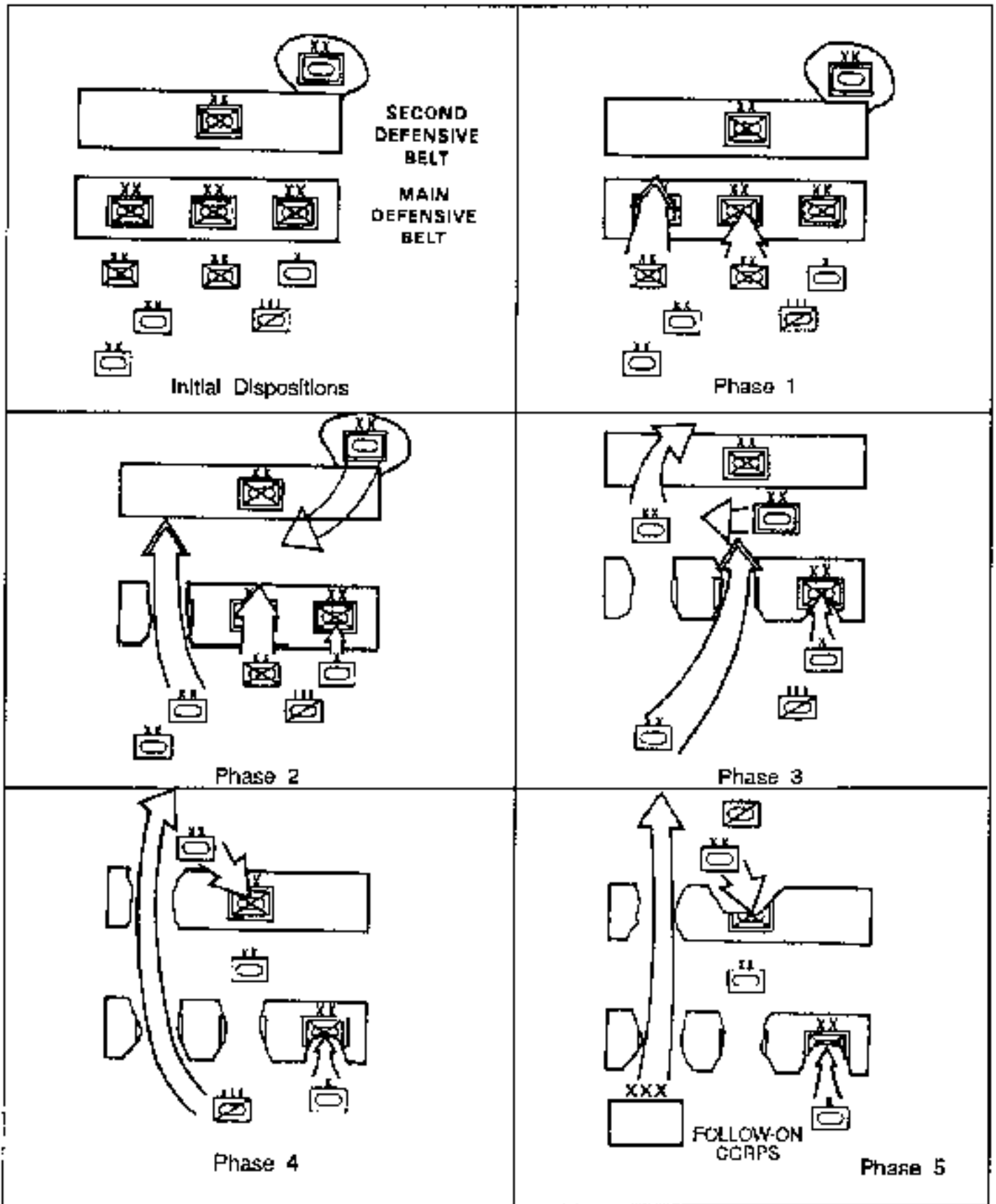

Figure 7-2. XX Corps' concept of the operation.

## THE SCHEME OF CHEMICAL SUPPORT

The corps commander's guidance on chemical support is--

- Provide the forces making the penetration with smoke support to ensure their success.
- Allocate and position NBC recon systems to facilitate freedom of maneuver.
- Accept risk in the forward area against chemical strikes. Ensure decon support is available to CSS supporting the attacking divisions. I cannot have an interruption of support to the forward combat units.
- Because of the flexibility in the plan, we can shift forces from the divisions initial attack to the divisions passing through them.
- Ensure the follow-on divisions are not delayed by deep chemical attacks and chemical assets to carry out their missions.

[Table 7-1](#) shows the available and committed chemical units supporting the corps for this making the have sufficient operation. The committed chemical units are those already performing support missions or those assigned to the corps subordinate units. The available forces are those that have not been assigned missions for the upcoming operation.

**Table 7-1. Available and committed chemical units  
in support of XX Corps.**

TYPE UNIT	AVAILABLE		COMMITTED	
	Company	Platoon	Company	Platoon
MECH SMOKE	4	12		
MOTOR SMOKE	4	8		
DECON	6	30		
RECON	1	3		
HEAVY DIVISION			4	—
DECON			—	16
MECH SMOKE			—	4
RECON			—	4
ACR			1	—
SMOKE/DECON			—	1
RECON			—	1
SEP BDE SMK/ DECON/RECON			—	1
CHEM BN HHD	3		—	—

The chemical brigade assisted by the corps chemical staff develop a scheme of support which is approved by the corps commander and executed by the chemical brigade. The approved concept is--

- Support the corps main effort (52d ID) with a chemical battalion (OPCON) consisting of two mech smoke company, and a motorized smoke company.
- Support the 54th ID with a mech smoke company and a motorized smoke company (OPCON). Support the 23d AD with a mech smoke company (DS).

- Support the 25th AD with a motorized smoke company (DS).
- Support the 313th separate armored brigade (SAB) with a motorized smoke company (DS).
- The remaining chemical assets will support the corps rear area.
- The two chemical battalions will have area support missions ([Figure 7-3](#)).

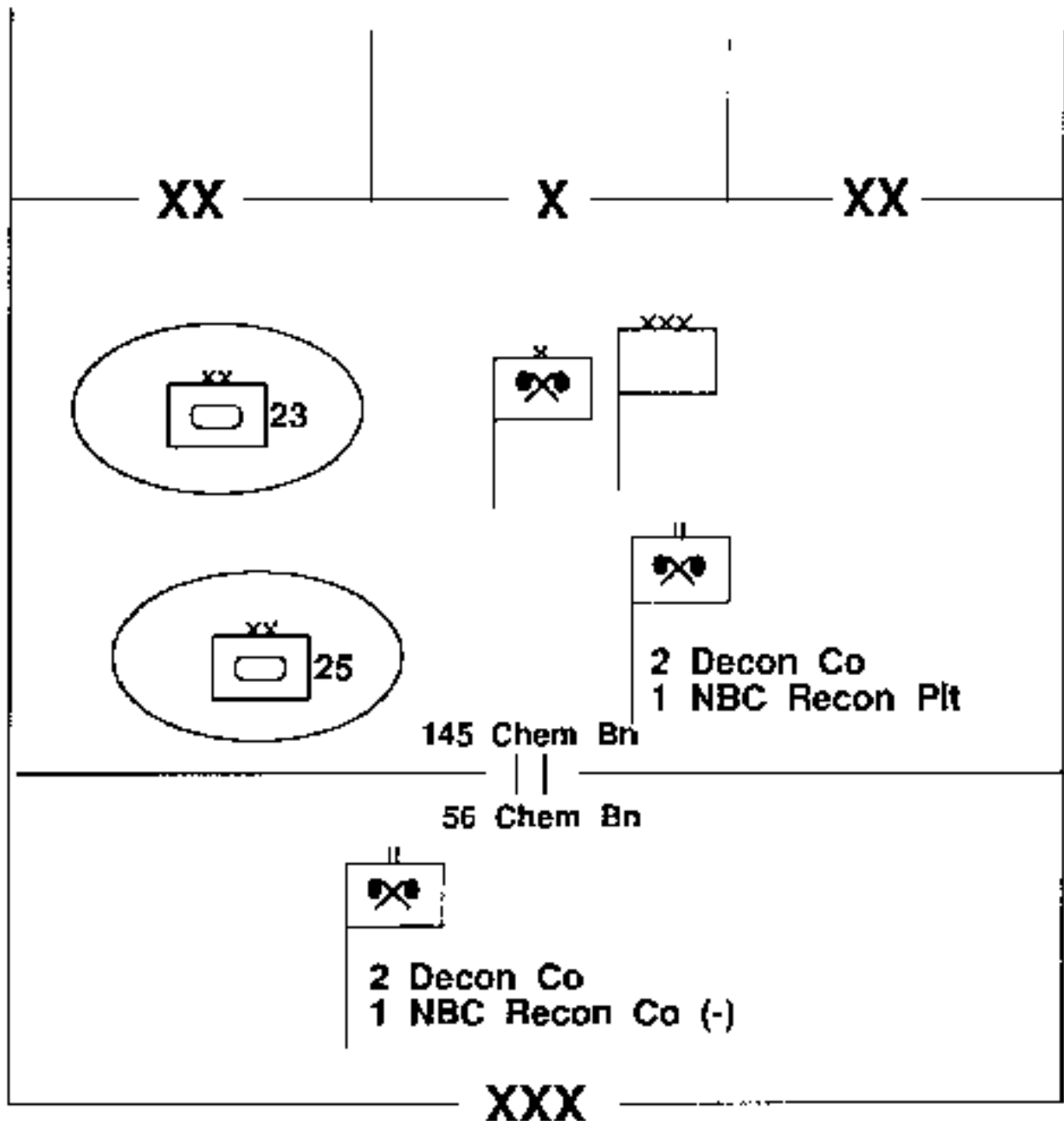

Figure 7-3. Chemical support to the corps rear.

## THE CORPS MAIN EFFORT

The 52d ID is the corps main effort with the mission to penetrate the first defensive belt and pass the 23rd AD forward to penetrate the second defensive belt. The division has been reinforced with an OPCON chemical battalion consisting of two mech smoke companies, a motorized smoke company, and a smoke/decon company. The division's scheme of maneuver is to attack with the 1st Brigade as the main effort to penetrate the first echelon positions and pass the 3d Brigade through to penetrate the second echelon positions. The 2d Brigade will conduct a supporting attack in the west. A battalion task force will conduct a feint in the east.



The division commander provides the following guidance on the employment of chemical assets--

- Support the main effort with smoke and NBC recon. I want to minimize the enemy's long-range fires as we breach.
- I want some smoke support with the task force conducting the feint to deceive the enemy as to the true size of that force. I want them to think that it's a brigade attacking them.
- My priority of decon is to the FA. I want them to keep up sustained fires throughout this operation.
- I will accept risk with the supporting attack.

The division chemical officer and supporting chemical battalion commander developed the scheme of support which is approved by the division commander (see [Figure 7-5](#)). The division chemical company will be OPCON to the chemical battalion. The chemical support plan for the division is--

- Support 1st Brigade (main effort) with a reinforced mech smoke company divisional smoke platoon attached, two NBC recon squads, and a decon platoon in DS.
- Support 2d Brigade (the supporting attack) with a mechanized smoke

company, a decon platoon, and one NBC recon squad in DS.

- Support the 3d Brigade (the reserve) with a motorized smoke company (-) and a decon platoon in DS.
- Support the task force conducting the feint with a motorized smoke platoon in DS. The division chemical company (-) is in GS with the mission of providing decon support to the division rear.
- The chemical battalion TOC will position itself near the division main CP.

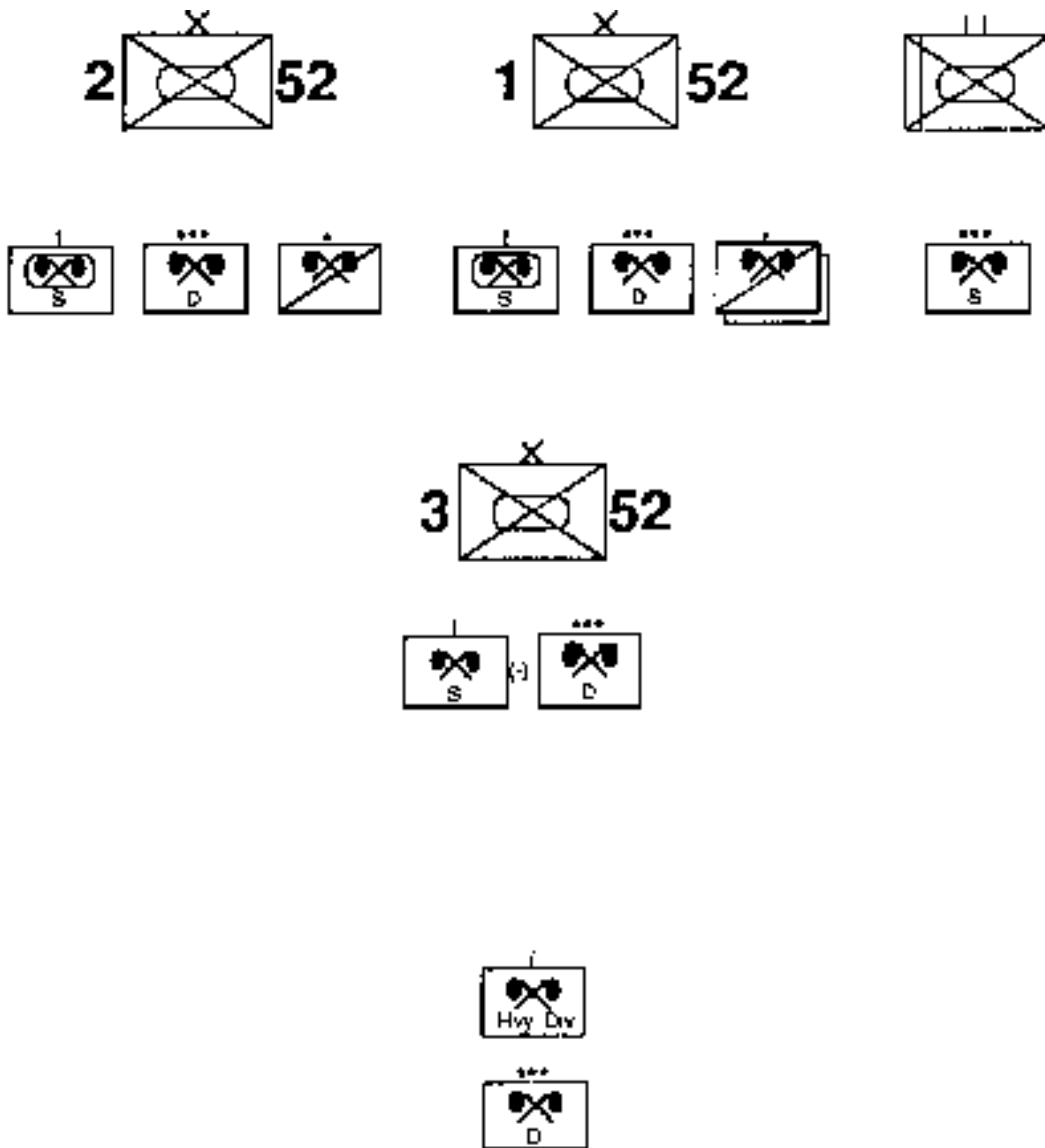

Figure 7-5. Concept of chemical support for the 52d ID.

## THE DIVISION MAIN EFFORT



The 1st Brigade is the 52d Mech's main effort with the mission of penetrating the first echelon defensive positions in the first defensive belt. The brigade is task-organized with two tank battalions, mechanized infantry battalion, a combat engineer battalion in DS, a field artillery battalion in DS, along with the typical slice of division troops. The division has given the brigade a chemical company team comprised of four mech smoke platoons, a decon platoon, and two NBC recon squads in DS.

The brigade commander's scheme of maneuver is to use a balanced TF as the support force, an armor-heavy TF as the breaching force, and an armor-heavy TF as the assault force (see [Figure 7-6](#)). The brigade commander provides the following guidance on the employment of the chemical company team--

- I want to protect the breaching force with smoke, but the engineers have to be able to see what they're doing.
- If the breach gets hit with gas, I want to be able to conduct operational decon fast.
- The support force needs NBC recon support to quickly find by-passes if they hit contamination as they move forward.
- I want the enemy in the west to think we're going to breach there, so I want a little smoke over there.
- I also want smoke support for the assault force.

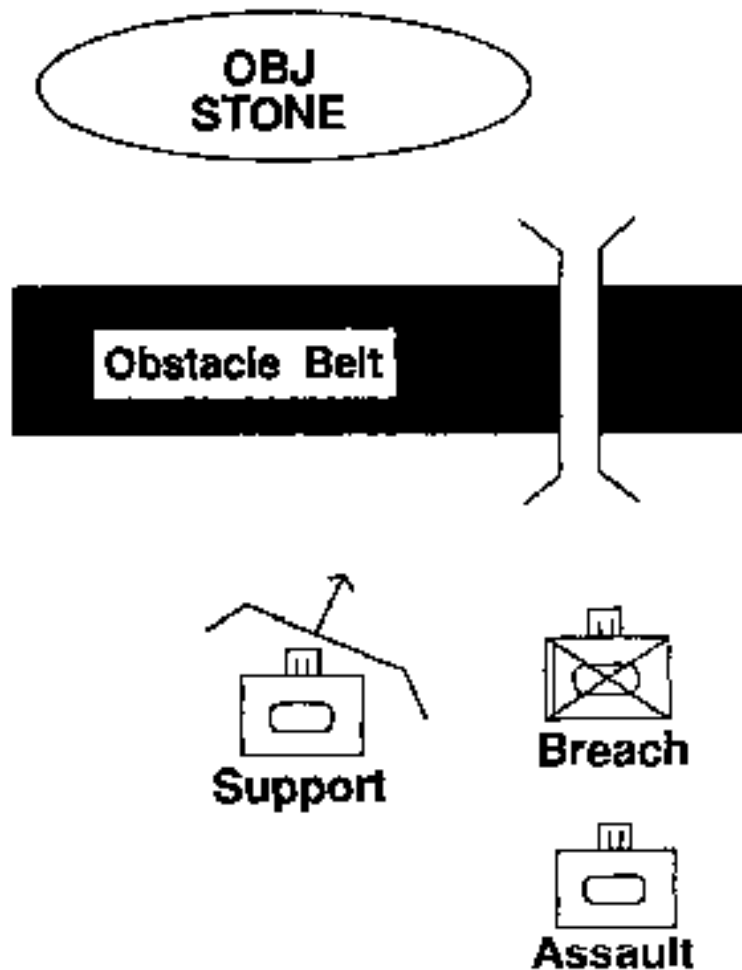

Figure 7-6. 1st Brigade, 52d ID's scheme of maneuver.

The brigade chemical officer and the chemical team commander working closely with the brigade S3 develops a chemical support plan (see [Figure 7-7](#)). The brigade commander approves the chemical support plan. The chemical support plan for the brigade is to--

- Designate one smoke platoon to support the support force. After the breach is made, this platoon's priority of support will shift to the assault force
- Designate two smoke platoons to support the breach force.
- Position the decon platoon at the chemical company team's CP with a support priority to units in the breach, fire support, support force, and CSS.
- Both NBC recon squads will provide support initially to the support force. Once the breach is made, one squad will provide

support to the assault force, while the other squad will provide support to the breach site.

- The platoons and squads will receive class I and III support from the task forces they are supporting. The smoke platoons and NBC recon sections will monitor the task force's command net, while the chemical company team will monitor the brigade operations and intelligence (O&I) net. The chemical company team commander will provide situation reports to the chemical battalion commander via MSE or other available communications means every four hours. The decon platoon will monitor the chemical company team's net. The chemical company team commander will drop to the platoon internal nets to monitor, request information, or pass instructions.

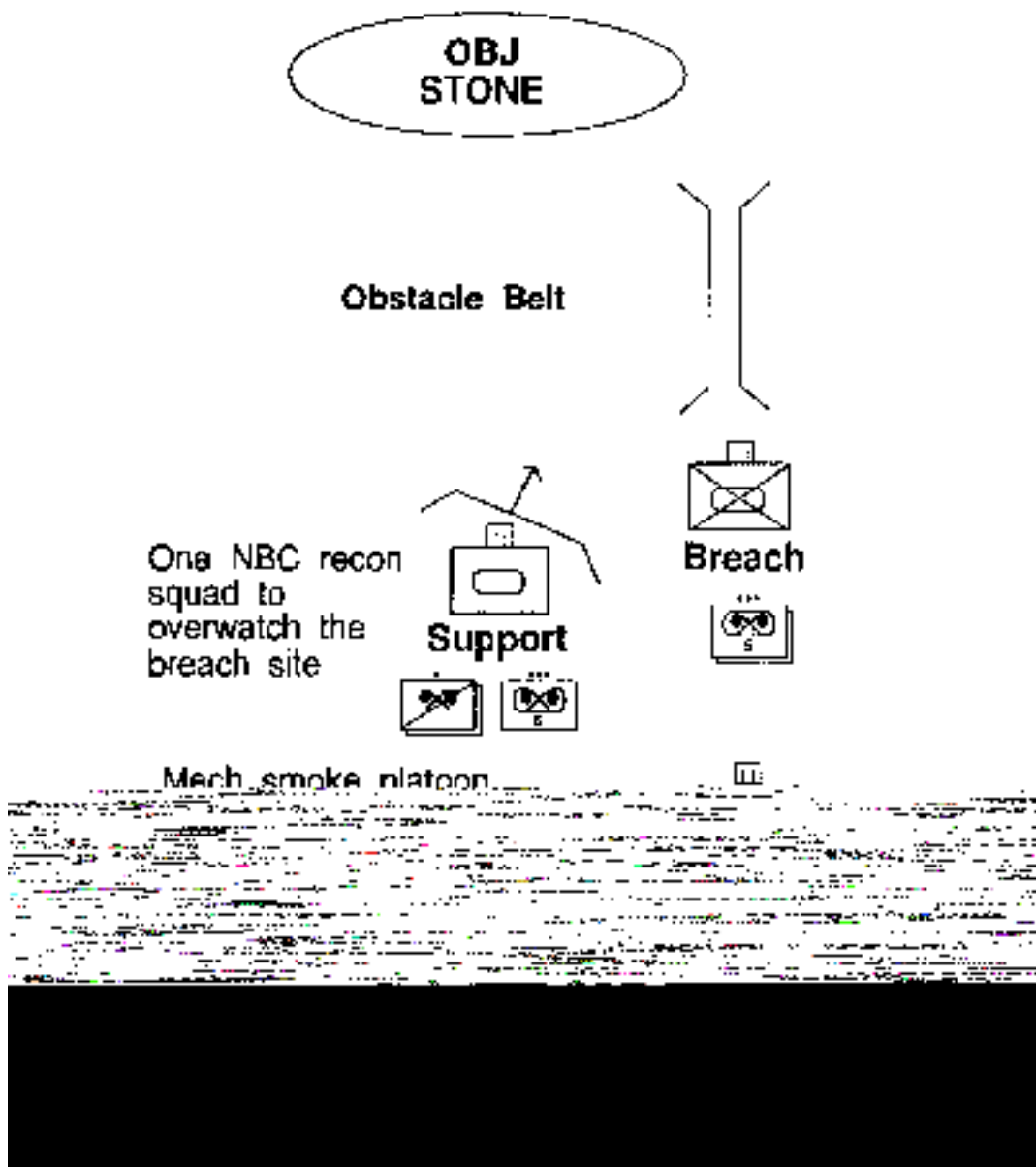

[RDL](#)[Table of](#)[Document](#)[Download](#)[Homepage](#) [Contents](#) [Information](#) [Instructions](#)

---

## CHAPTER EIGHT

# DEFENSIVE OPERATIONS

Defensive operations retain ground, gain time, deny the enemy access to an area, and damage or defeat attacking forces. The defense can deny the enemy victory. It cannot assure victory. The defense is a temporary state that creates the conditions that allow the force to assume offensive operations. Defensive operations are conducted to---

- Defeat an enemy attack.
- Gain time.
- Concentrate forces elsewhere.
- Control key or decisive terrain.
- Wear down enemy forces as a prelude to offensive operations.
- Retain strategic, operational, or tactical objectives.

Just as during offensive operations, defending forces must use NBC defensive principles--avoidance, protection, and decontamination--to preserve combat power under NBC conditions and smoke to enhance combat power.

The defensive framework consists of--

- Security force operations forward and to the flanks of the defending force.
- Defensive operations in the main battle area (MBA).
- Reserve operations in support of the main defensive effort.

- Deep operations in the area forward of the forward line of own troops (FLOT).
- Rear operations to retain freedom of action in the rear area.

Chemical units are integrated throughout the defensive framework--

Security. Smoke and NBC recon unit provide the security force commander versatility.

MBA. Smoke and NBC recon units provide the commander versatility, while decon units increase the survivability of contaminated units.

Reserve. Smoke, NBC recon, and decon units increase the survivability of reserve forces. Smoke and NBC recon units provide the commander versatility.

Deep. Smoke and NBC recon units provide versatility and increase survivability.

Rear. Smoke, NBC recon, and decon units assist the commander to retain freedom of maneuver and increase survivability.

## **CONDUCTING THE DEFENSE**

### **PATTERNS OF DEFENSIVE OPERATIONS**

#### **Mobile Defense**

Mobile defense employs a combination of offensive, defensive, and delaying actions to defeat an enemy attack. The exact design is dependent upon METT-T. In this type of defense, a small force is deployed forward in the sector and uses a combination of fire and obstacles to seize the initiative from the attacker. A force conducting a mobile defense must have the same or greater mobility as that of the attacker. The force must have a large reserve to conduct the decisive counterattack. Because of the need to have a large reserve, mobile defenses are normally conducted by division or larger forces.

## Area Defense

An area defense is normally conducted to deny the enemy access to specific terrain for a specific time. The purpose of the area defense is to retain ground using a combination of defensive positions and a small reserve. This type of defense is used when there is little depth to the sector. The exact design of this defense is also dependent upon METT-T.

## **THE COVERING FORCE FIGHT**

Corps and division may establish a covering force as the first echelon of a two echelon function of the covering force is to destroy the leading elements of the attacking force causing the follow-on forces and forcing the enemy to disclose his main effort. The size and composition of the defense. The deployment of covering force is dependent on METT-T. Normally a covering force is organized around tank-heavy task forces and armored cavalry regiments.

Normally, the covering force will defend, delay, and attack with its maneuver units. When elements of the covering force are unable to retain terrain forward of the FEBA, they will withdraw through the element conducting the defense of the main battle area. Generally the covering force withdraws by unit.

Because of its nature, covering force elements that become contaminated probably will not undergo any supported decon operations (operational or thorough) until they have withdrawn through the MBA. If the unit must undergo decon, it will most likely be operational.

NBC reconnaissance units will provide the covering force commander with versatility. Their focus should be on determining the status (clear or contaminated) of rearward passage lanes. If they are contaminated, NBC recon units will locate and mark new clear routes.

Smoke units conceal movement of friendly forces, defeat enemy intelligence gathering efforts, and conceal the emplacement of obstacles. Smoke provides the commander with versatility and agility. Smoke is also used to support deception operations.

## Chemical Brigade

The chemical brigade will plan and allocate chemical units based on METT-T. The focus should be three-fold--support the covering force, provide support to units in the main battle area, and retain a flexible and responsive chemical force in the rear area. The units in the covering force will require support in the form of smoke and NBC recon. If an ACR is used, their chemical company may require reinforcement with smoke and NBC reconnaissance assets. Most of the mechanized smoke units should be employed between the covering force area and the main battle area.

## **Chemical Battalion**

Chemical battalions are allocated based upon METT-T. Unless there are unusual circumstances, the covering force will not require a chemical battalion HHD. The chemical battalions should be allocated to support the divisions conducting the corps main and supporting efforts. At least one battalion HHD should be allocated to control chemical assets in the corps rear. The command and support relationships of the battalions supporting the divisions are based upon providing the supported commander with sufficient versatility to prepare his defense.

## **Chemical Companies**

If the armored cavalry regiment is deployed as the covering force, its organic chemical company also will operate in the covering force area. The ACR chemical company will deploy its NBC recon platoon based on the enemy threat of using ground contaminating chemical agents. Its focus should be on maintaining freedom of maneuver behind the units in close combat. One section should be designated to ensure the main and secondary routes to and through the MBA are clear of contamination for each squadron. The dual purpose platoon's main focus will be smoke generation. The platoon's decon equipment should be left with the company headquarters. The dual purpose platoon will provide smoke support based on METT-T. If smoke support is required beyond the scale that the dual purpose platoon can provide, the ACR company should be reinforced with mechanized smoke platoons and fuel support sections from a corps chemical battalion.

If a unit other than an ACR is conducting all or part of the covering force, that unit should be supported by a chemical company team. This chemical company team should have a NBC reconnaissance platoon, at least one mechanized smoke platoon, and a headquarters capable of

providing C<sup>2</sup> and CSS support.

## Chemical Staff Considerations

- Focus NBC defense operations to provide the commander versatility and synchronization.
- Operate in the lowest possible MOPP level during the preparation phase, then consider a higher MOPP for the actual battle.
- Plan smoke to assist in breaking contact and repositioning.
- Select decon sites throughout the covering force area.
- Conduct operational decon operations as necessary for survivability.
- Focus NBC reconnaissance assets on repositioning and withdrawal routes, also on passage points and passage lanes.
- Identify alternate routes if passage routes become contaminated.
- Designate passage points and lanes for the movement of contaminated elements.
- Plan smoke to disrupt attacking enemy echelons.
- Balance vulnerability of the force against the need for mass, agility, and depth.
- The possibility of enemy NBC attacks increases just prior to the enemy attack.

## **THE MAIN BATTLE AREA FIGHT**

The main battle area fight begins when the battle handover has occurred. The units in the MBA begin the close battle, while corps continues deep operations against the enemy's second echelon. The enemy attack will be defeated in the MBA.

Smoke is used to defeat enemy target acquisition, slow the enemy,



separate and piecemeal attacking forces, and disrupt enemy command and control. Smoke is also used to obscure repositioning forces. Additionally, smoke can be used as part of deception operations. Mechanized smoke units should support maneuver forces.

NBC reconnaissance units are positioned throughout the MBA based upon the IPB. The employment of NBC recon assets will provide freedom of movement and allow the commander to reposition forces without the fear of hitting contamination. Additionally, NBC recon assets can be used to patrol the MSRs.

Decon assets are also positioned and allocated based on the IPB. Priority of decon support should be to reserve forces, fire support units, combat service support, combat support, and committed forces. Operational decon may be conducted in support of committed forces to sustain combat operations. Thorough decon sites should be established away from the major avenues of approach into the sector and outside the range of the enemy's indirect fire systems. This could be up to 20 kilometers or more.

## **Chemical Brigade**

During the MBA fight, the chemical brigade will monitor the status of the subordinate chemical units and the NBC situation. The brigade also monitors the reconstitution efforts of the chemical units involved in the covering force area (CFA) fight.

The units conducting the MBA fight will require a mix of chemical support. Reserve forces will need NBC recon assets to allow them to move rapidly on the battlefield without undo risk from contamination. Additionally, smoke assets will allow the reserve to conceal their movement.

## **Chemical Battalion**

Unless there is a significant change in the NBC situation, there should be little change in the employment of the chemical battalion from the CFA battle to the MBA battle. The battalions monitor the status of their subordinate units and the overall NBC situation. They identify possible situations and wargame their reactions.

## **Chemical Companies**

The priority for CFA units is to reconstitute themselves to a fully mission capable posture. MBA units need to remain flexible. They should position themselves to best provide support. However they should avoid high-speed avenues of approach into their sectors. They must maintain communications with their higher and supporting unit's headquarters. They prepare to encounter enemy reconnaissance elements moving through the sector. If possible, these enemy reconnaissance elements are engaged and destroyed.

Selection of decon sites is coordinated with the supported unit and higher headquarters to preclude using a key piece of terrain.

### **Chemical Staff Considerations**

- Focus NBC defense operations to provide the commander versatility and synchronization.
- Operate in the lowest possible MOPP level during the preparation phase, then consider a higher MOPP for the actual battle.
- Select decon sites throughout the rear area to support the defensive scheme.
- Identify areas that the enemy could contaminate to hinder friendly operations.
- Focus NBC reconnaissance on repositioning and counterattack routes.
- Plan smoke to conceal obstacle emplacement.
- Use smoke to conceal movement of forces during mobile defense operations.
- Balance vulnerability of the force against the need for mass and depth.
- The possibility of enemy NBC attacks increases just prior to the enemy attack.

- Conduct operational decon as necessary to sustain the tempo of the defense.
- Execute thorough decon operations as necessary after the battle.
- Plan the use of flame field expedients along dismounted infantry avenues of approach.
- Consider the impact of enemy flame weapons on your defensive positions.

## **SYNCHRONIZING THE DEFENSE**

This section provides an example of how chemical units could be synchronized to support a defense. The corps mission is to defeat an attacking enemy combined arms army (CAA). The example will use the defensive framework and is only one example of a concept and should be treated as such. The corps portrayed in this example consists of one armored division, one mechanized division, a separate mechanized brigade, an armored cavalry regiment, an aviation brigade, and the associated combat support and combat service support units. A chemical brigade with all the subordinate chemical units for this size force are present and available for employment ([Figure 8-1](#)). The attacking enemy CAA consists of three motorized rifle divisions in the first echelon and two tank divisions in a staggered second echelon. The first echelon division will attack with two regiments in their first echelon and two regiments in their second echelon. The enemy has an extensive chemical weapons capability and a limited nuclear capability. He has used chemical weapons extensively during both defensive and offensive operations. No nuclear weapons have been used.

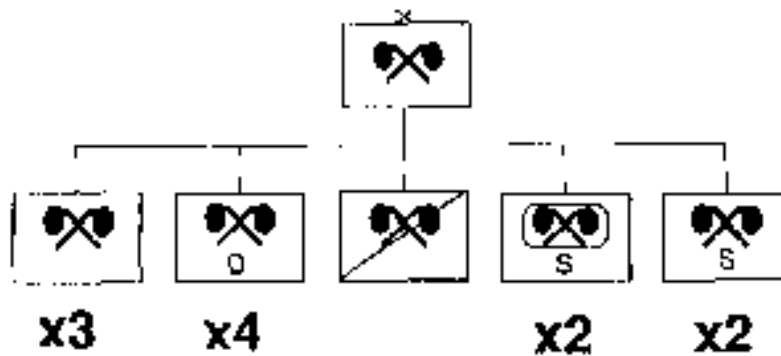

Figure 8-1. Organization of the chemical brigade in support of the corps.

## THE MISSION

The mission of the corps is to defeat the attack of the first echelon of the CAA. Following the defeat of the CAA, the corps will either reestablish the defense to defeat the second echelon of the CAA or attack as part of a counteroffensive. Both of these sequels could be conducted. The corps commander's intent is to defeat the CAA with a mobile defense throughout the depth of the MBA.

The MBA units will defeat the first echelon divisions and shape a penetration of the CAA's tank division. The corps reserve will attack into the salient created by the penetration to destroy the tank division. The corps commander envisions that the CAA will be defeated if the three lead motorized rifle divisions and one of the second echelon tank divisions are destroyed.

## THE GENERAL SCHEME OF MANEUVER

The corps covering force, the 201st Armored Cavalry Regiment augmented with two balanced task forces, will fight to destroy at least 50 percent of the lead regiments in the first echelon division. Following battle handover, the MBA units will defeat the attrited first echelon divisions in the MBA. The 313th Infantry Brigade (Separate) on the right will defeat the enemy division forward of PL Gold, while the 52d Infantry Division (Mech) on the left voluntarily shapes a salient back to PL Gold to draw in the lead second echelon tank division. The corps reserve, the 23d Armored Division, will then counterattack into the

salient to destroy the enemy tank division. The corps defense will then be reestablished with both divisions and the separate mechanized brigade along a newly defined FEBA ([Figure 8-2](#)).

## THE SCHEME OF CHEMICAL SUPPORT

The corps commander's guidance on chemical support is to--

- Provide the covering force with smoke support to ensure their success.
- Allocate and position NBC recon systems to facilitate maneuver with priority to the covering force, then the MBA forces.
- Accept risk in the covering force area against chemical strikes. I don't want to conduct any decon operations in the covering force unless I have no choice.
- I want the corps reserve to have sufficient smoke support to conduct their counterattack.
- The priority of chemical support is to the main effort.

[Table 8-1](#) shows the available and committed chemical units supporting the corps for this operation. The committed chemical units are those already performing support missions or those assigned to the corps subordinate units. The available forces are those that have not been assigned missions for the upcoming operation.

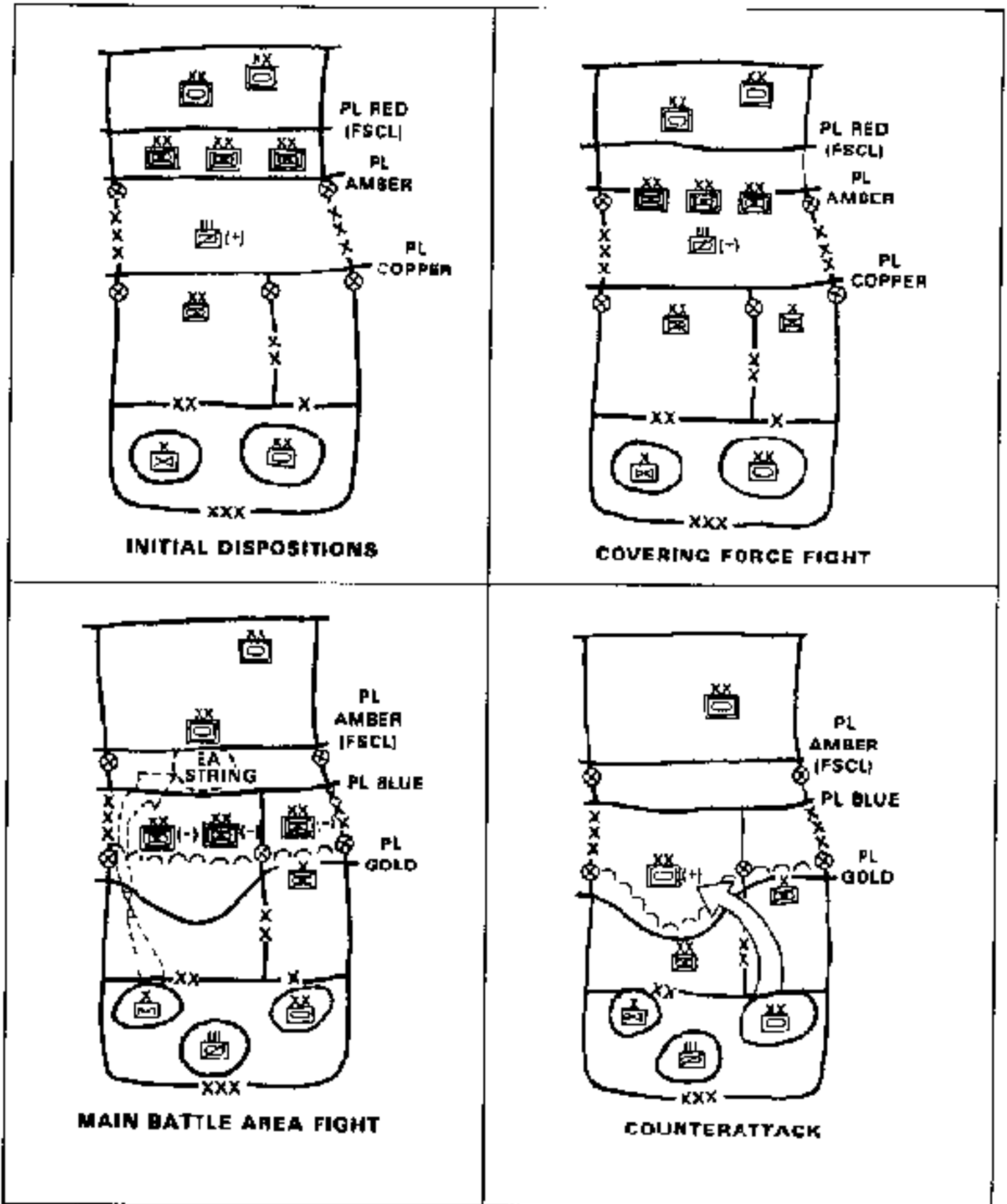

Figure 8-2. XXX Corps' scheme of maneuver.

Table 8-1, Available and committed chemical units in support of the corps

TYPE UNIT	AVAILABLE		COMMITTED	
	Company	Platoon	Company	Platoon
MECH SMOKE	2	6		
MOTOR SMOKE	2	4		
DECON	4	20		
RECON	1	3		
HEAVY DIVISION DECON MECH SMOKE RECON			2 - - -	- 8 2 2
ACR SMOKE/DECON RECON			1 - .	- 1 1
SEP BDE SMK/DECON/RECON				1
CHEM BN HKD		3		

The chemical brigade commander assisted by the corps chemical staff officer and the chemical brigade S3 develop a scheme of support. This scheme of support is approved by the corps commander and is executed by the chemical brigade. The approved concept is to--

- Support the 201d ACR (corps covering force) with a mechanized smoke company (attached).
- Support the 52d ID (corps main effort) with a chemical battalion (OPCON) consisting of a mech smoke company and a motorized smoke company.
- Support the 23d AD (corps reserve) with a chemical battalion (OPCON) consisting of a motorized smoke company and a mechanized smoke company (this smoke company is initially with the covering force).
- The remaining chemical assets support the corps rear area. The

remaining chemical battalion will have an area support mission.

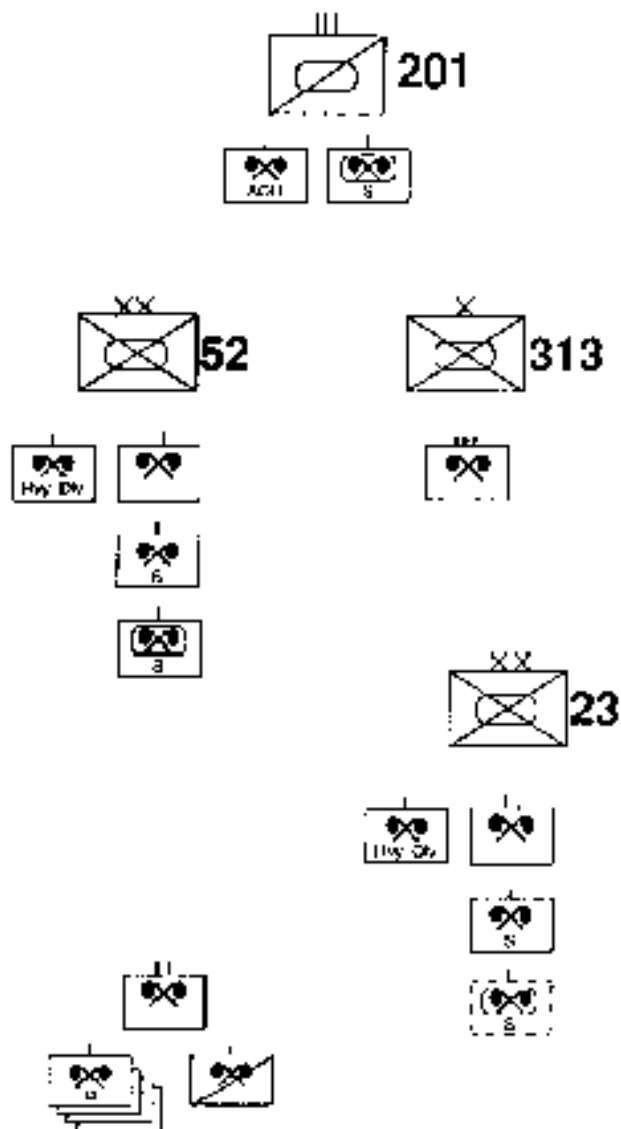

Figure 8-3. Allocation of chemical units in support of the corps.

## THE CORPS MAIN EFFORT

The 52d ID is the corps main effort. The division has the mission to defend from PL Blue to PL Gold. The division will defeat the attrited first echelon division and voluntarily shape a salient back to PL Gold to draw in the lead second echelon tank division. The division will hold the enemy tank divisions penetration forward of PL Gold, while the armored division attacks into the left flank of the enemy tank division.

The division will defend with three brigades abreast; 2d Brigade on the left, 1st Brigade in the center, and 3d Brigade on the right. The 1st



Brigade is the main effort and will conduct a mobile defense from PL Blue to PL Gold to draw the enemy second echelon tank division into Objective Red. The 2d and 3d Brigades will hold the shoulders of the penetration. 3d Brigade will assist the passage of the corps reserve through their sector for the counterattack. The division reserve will be the aviation brigade augmented by a mechanized task force ([Figure 8-4](#)).

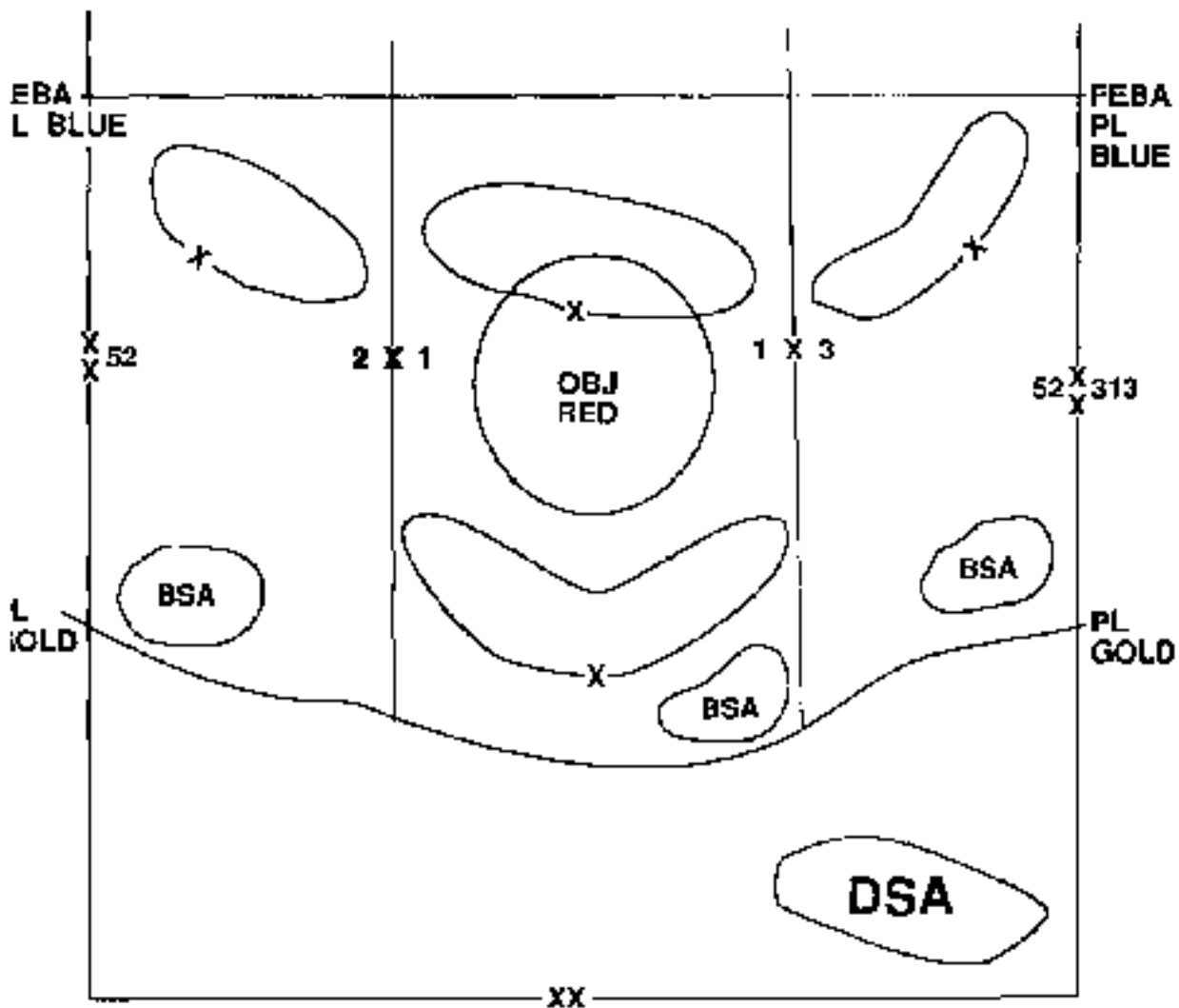

Figure 8-4. 52ID's concept of the operation.

The division commander provides the following guidance on the employment of chemical assets--

- Give the supporting efforts (2d and 3d Brigades) smoke. I want to obscure the preparation of the defense in those sectors and let the enemy see the defensive work in the center. I want to show strength on the right and left flanks so he'll go in the center.

- Priority of NBC recon is to the 1st Brigade so he can maneuver freely to shape the penetration.
- My priority of decon is to the FA. I want them to keep up throughout this operation.
- I will accept risk during the MBA fight.

The division chemical officer and supporting chemical battalion commander developed the recommended scheme of support ([Figure 8-5](#)). The division commander approves the recommended plan. The division chemical company will be OPCON to the chemical battalion. The chemical support plan for the division is--

- Support 1st Brigade (main effort) with two NBC recon squads (four vehicles), their habitual decon platoon, and the divisional smoke platoon in DS.
- Support 2d Brigade with a mechanized smoke company and a decon platoon in DS.
- Support the 3d Brigade with a motorized smoke company, a decon platoon, and an NBC recon squad (two vehicles) in DS. The NBC recon squad will ensure the freedom of maneuver of the corps counterattack force through the brigade sector.
- The heavy division chemical company (-) with its fourth decon platoon is in GS with the mission of providing decon support to half the division rear.
- The chemical battalion TOC will position itself near the division main CP.

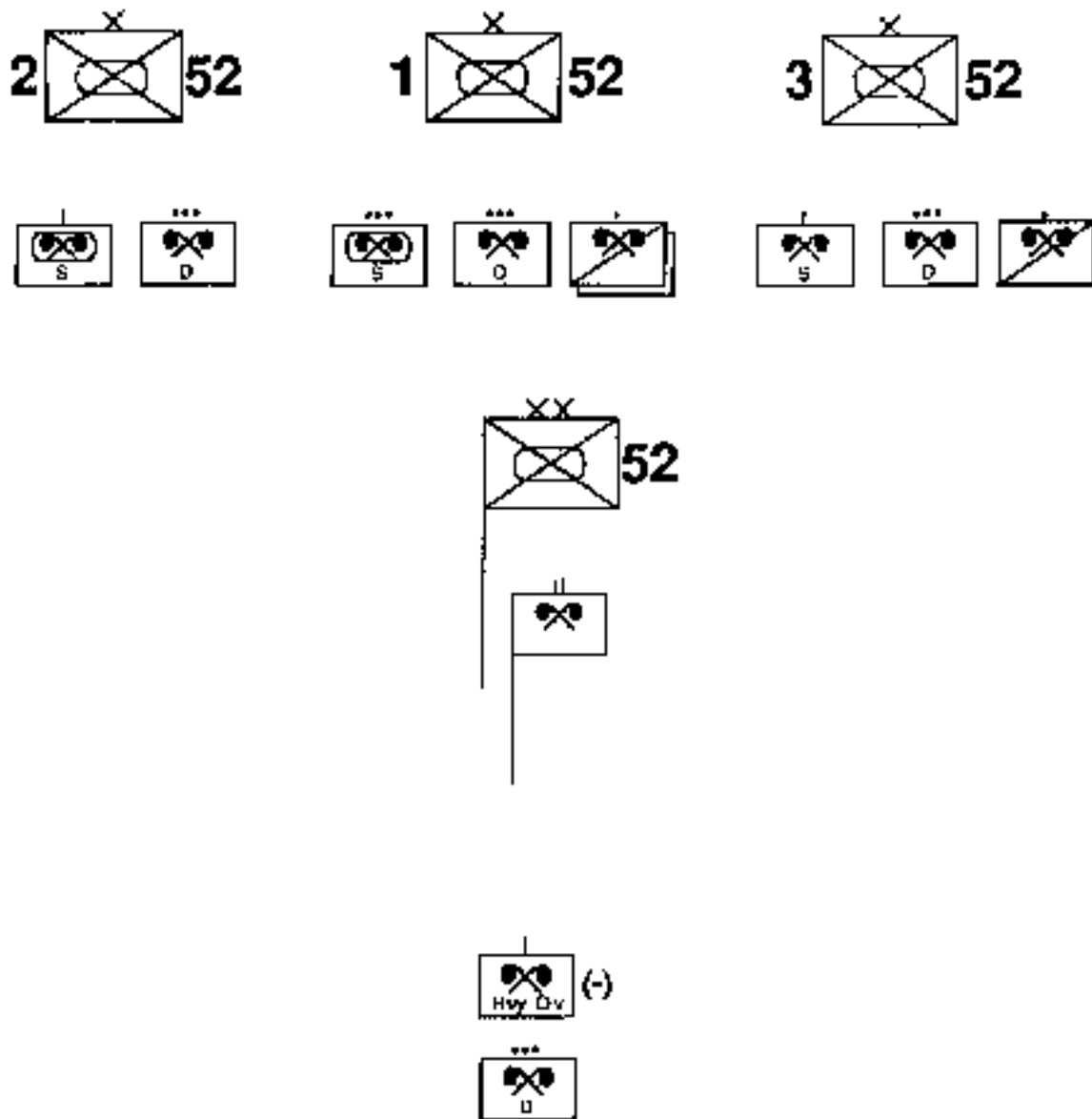

Figure 8-5. Allocation of chemical units in support of the 52d ID.

## AT THE DIVISION SUPPORTING EFFORT

The 2d Brigade has the mission of defending in sector from PL Blue to PL Gold. The brigade will hold the left shoulder of the planned penetration into the 1st Brigade's area. The brigade is task-organized with two mechanized infantry battalions, a tank battalion, a combat engineer battalion in DS, a field artillery in DS, along with the typical slice of division troops. The division has given the brigade a mechanized smoke company and a decon platoon in DS ([Figure 8-6](#)).

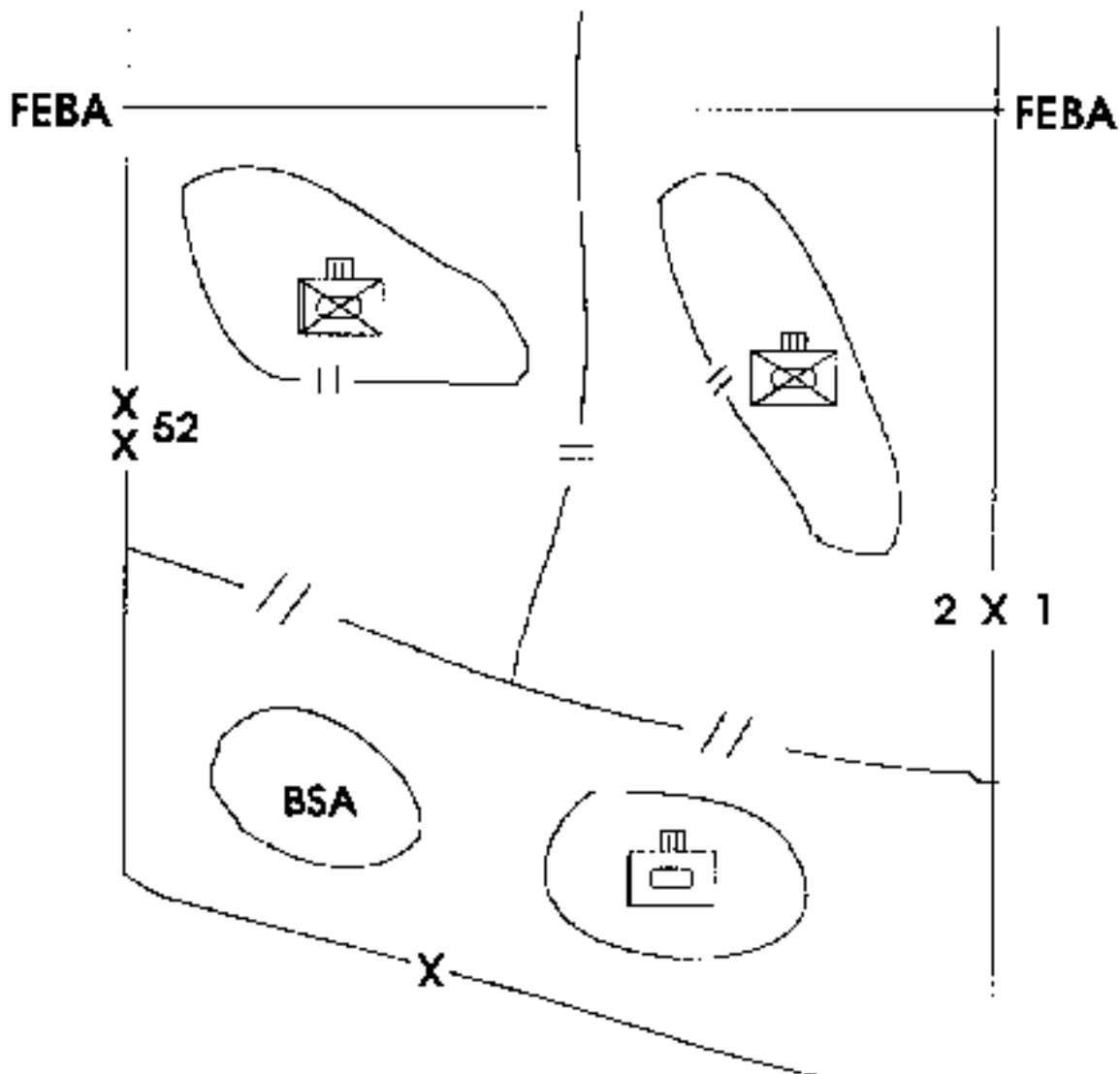

Figure 8-6. 1st Brigade, 52d ID's concept of the operation,

The brigade commander's scheme of maneuver is to defend with the mechanized heavy TFs forward in battle positions. The balanced TF is the brigade reserve with a counterattack mission. The brigade commander provides the following guidance on the employment of the chemical assets--

- I want to obscure the emplacement of the obstacles with smoke, but the engineers have to be able to see what they're doing.
- After supporting the obstacle preparation effort. I want the smoke company to be prepared to support the counterattack.

The brigade chemical officer works with the smoke company commander to develop a recommended chemical support plan ([Figure 8-7](#)). They work

closely with the brigade S-3. The chemical support plan is approved by the brigade commander. The chemical support plan for the brigade follows--

- The smoke platoons will operate on an area basis to create a series of smoke hazes across the brigade's sector. As the covering force withdraws, the smoke company will cease smoke operations on order from the brigade commander in close coordination with the covering force commander. The smoke company then withdraws to the BSA to refit. After refitting, the smoke company will link up with the brigade reserve. The smoke company is prepared to support the reserve when it counterattacks with hasty smoke Support.
- The decon platoon will be positioned in the brigade support area (BSA) with a be-prepared mission of conducting thorough decon. This platoon and/or a corps decon platoon may be called on to decon portions of the covering force as it withdraws through the brigade area.
- The decon platoon will receive class I and III support from the forward support battalion in the BSA. The smoke company will draw all its support from the designated corps support group. The smoke company and the decon platoon will monitor the brigade's operations and intelligence (O&I) net.
- The smoke company commander will provide situation reports to the chemical battalion commander via MSE every four hours. The smoke company commander will tune in to the smoke platoon internal nets to monitor, request information, or pass instructions.
- Once the smoke company links up with the reserve, the company will monitor the TF's command net.

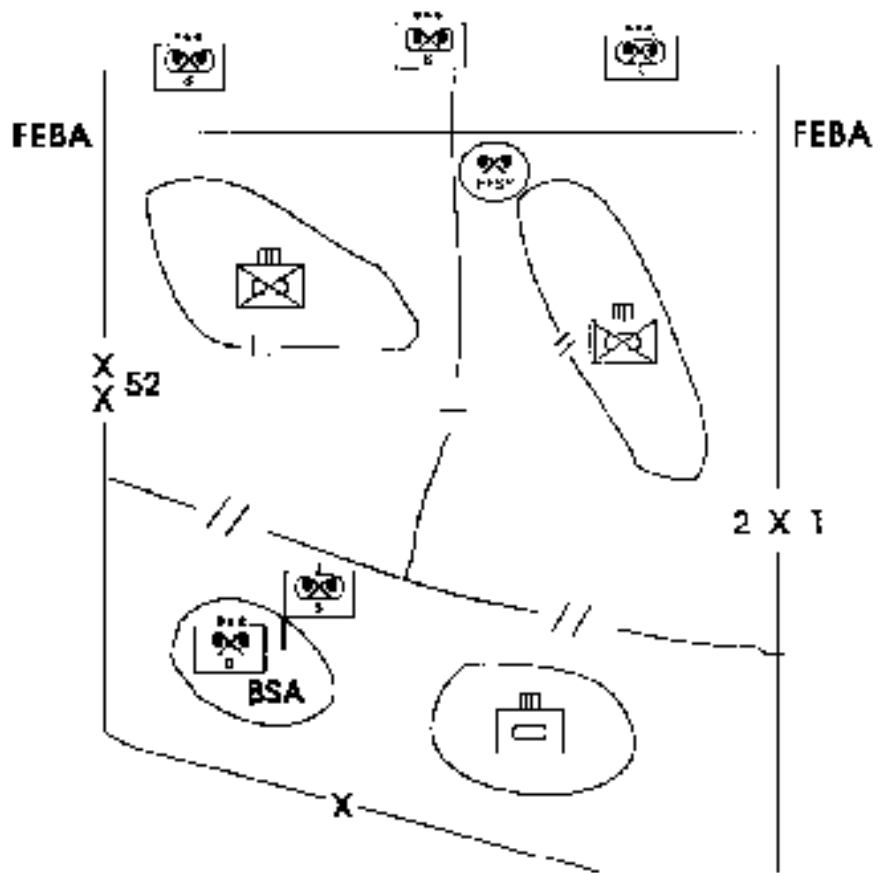

Figure 8-7. Chemical support concept for the 1st Brigade, 52d ID.



[RDL](#) [Table of](#) [Document](#) [Download](#)

[Homepage](#) [Contents](#) [Information](#) [Instructions](#)

---

## CHAPTER NINE

# REAR OPERATIONS

Operations in rear areas differ from operations in forward combat areas. At the corps level, the corps rear CP in coordination with corps G3, positions units in the rear area. Units will be positioned based upon the corps mission, concept of the operation, commander's intent, and their mission. Because of the size of the corps rear area, the rear CP executes rear operations through subordinate rear area operations centers (RAOCs). A RAOC is responsible for an area that normally coincides with a corps support group's designated area. [FM 90-13](#), *Rear Battle* provides information concerning rear operations.

## SECURITY

Rear area security operations ensure freedom of maneuver and continuity of operations. Once units are positioned in the rear they are designated by the responsible RAOC as either bases (unit or multi-unit positions with definite perimeters) or base clusters (grouping of bases based on mission and/or security requirements lacking a defined perimeter). The RAOC also designates a commander for each base and base cluster. The RAOC has OPCON for rear operations. Normal unit mission guidance and prioritization remains a chain of command responsibility. For example, mission taskings for a chemical battalion operating within a RAOC area of responsibility are assigned by the corps chemical brigade, not the RAOC.

## BASE AND BASE CLUSTER SELF-DEFENSE

Each base and base cluster develops a defense plan designed to detect, defeat, and minimize the effects of level I and limited level II threat attacks to include chemical attacks. These defense plans are consolidated by the RAOC. Each separate base and base cluster will establish an operations center capable of maintaining 24-hour

communications with the respective RAOC. Chemical units may be tasked to act as a response force for bases or base clusters under attack.

## **MOVEMENTS**

Movements in the rear area are often critical to the success of close, deep, and rear operations. Movement planning and control ensures that the freedom of maneuver is not impeded by friendly forces. Movement planning and control is often coordinated with host nation authorities.

### **TACTICAL MOVEMENTS**

The corps G3 is responsible for planning all tactical movements through or within the corps rear area. The corps rear CP assists in the planning and control of these movements. At all levels, tactical movements are planned by the operations officers. Chemical units conducting tactical movements coordinate with the appropriate CP.

### **NONTACTICAL MOVEMENTS**

CSS cells designate the main supply routes (MSRs) to forward positioned units. For example, division designates the primary and alternate MSRs from their rear area to the subordinate brigades. The CSS cells establish priorities for nontactical movement along the MSRs. Chemical units use the MSRs for their nontactical movement. Movement along the MSRs in the forward combat areas is usually more secure than movement along other routes.

## **REAR AREA CHEMICAL OPERATIONS**

### **COMMUNICATIONS ZONE (COMMZ)**

Each mature theater army area command (TAACOM) has an enhanced theater army chemical battalion HHD with two decontamination companies and one NBC reconnaissance company. A JB NBCE team is attached to the TAACOM and each area support group (ASG) to provide NBC staff support. Each theater defense brigade is also supported by a JB team. The chemical battalion can coordinate support operations through the use of area or task assignments. Depending on METT-T, the companies may be task organized to form chemical company teams.



Area support is provided by designating subordinate elements to support all organizations in an area. If possible, the designated areas should coincide with the areas of responsibility of the ASGs, for example, assign a decontamination company to provide decon support to all units in the 23d ASG's area ([Figure 9-1](#)).

Allocate workload to chemical units by assigning tasks to specific units, for example, assign a decontamination company to operate four fixed decontamination sites ([Figure 9-2](#)).

Units requiring immediate chemical support (decontamination or NBC reconnaissance) would pass their requirements through the base or base cluster to the supporting ASG. The ASG would task the supporting chemical unit. For routine chemical support (not as a result of a NBC attack), the ASG would send the requirement to the TAACOM who processes the request through the chain of command to the chemical unit.

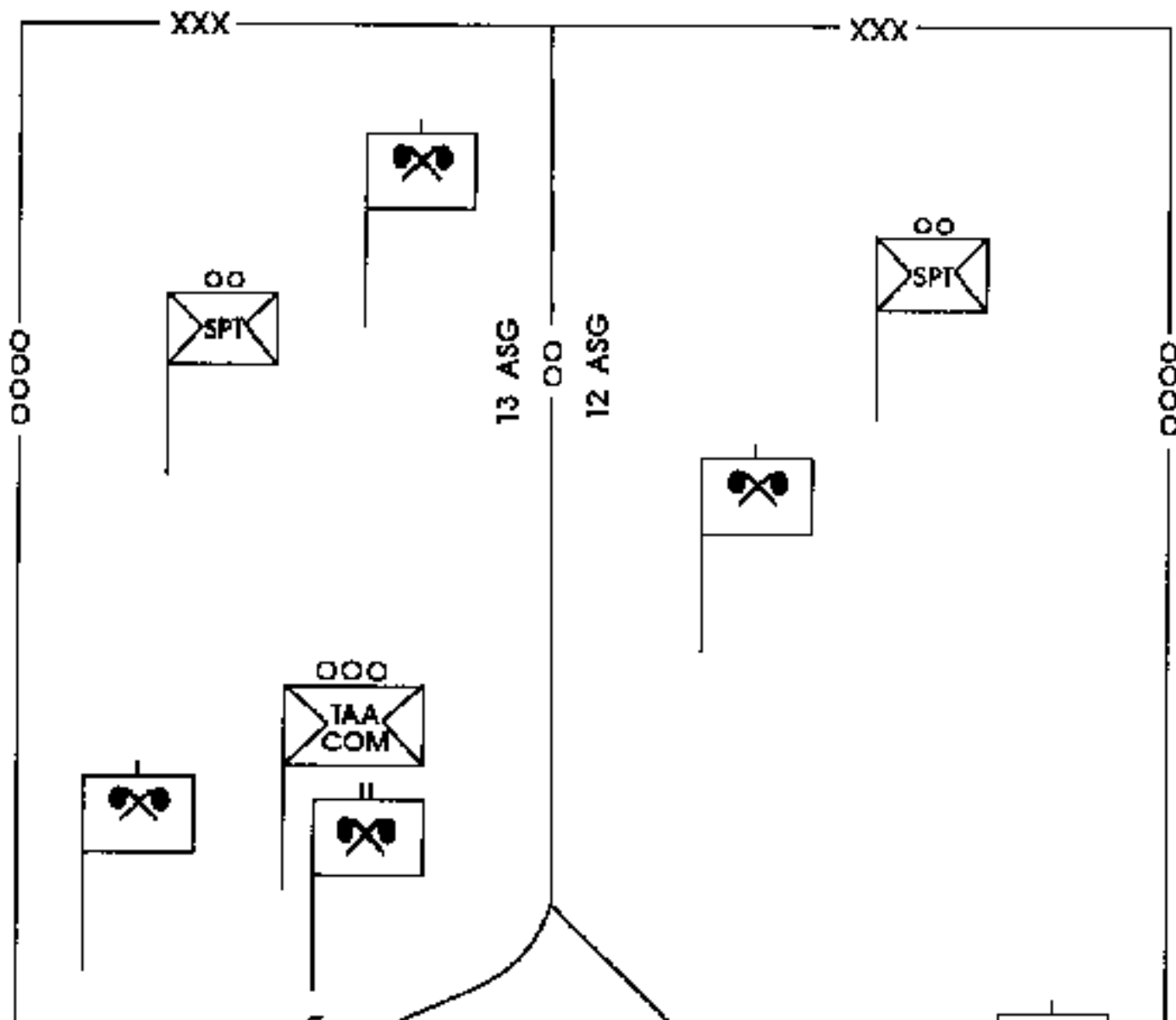

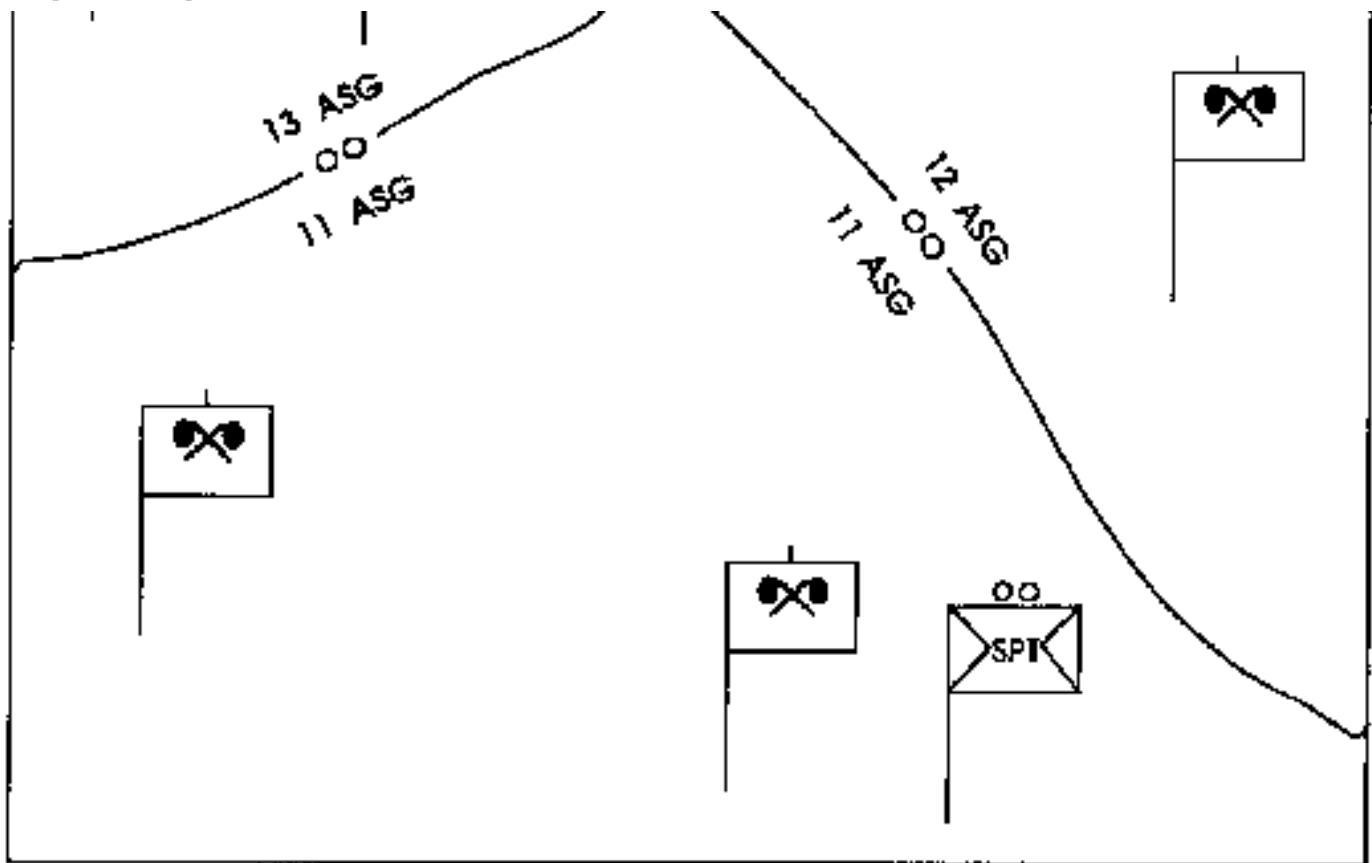
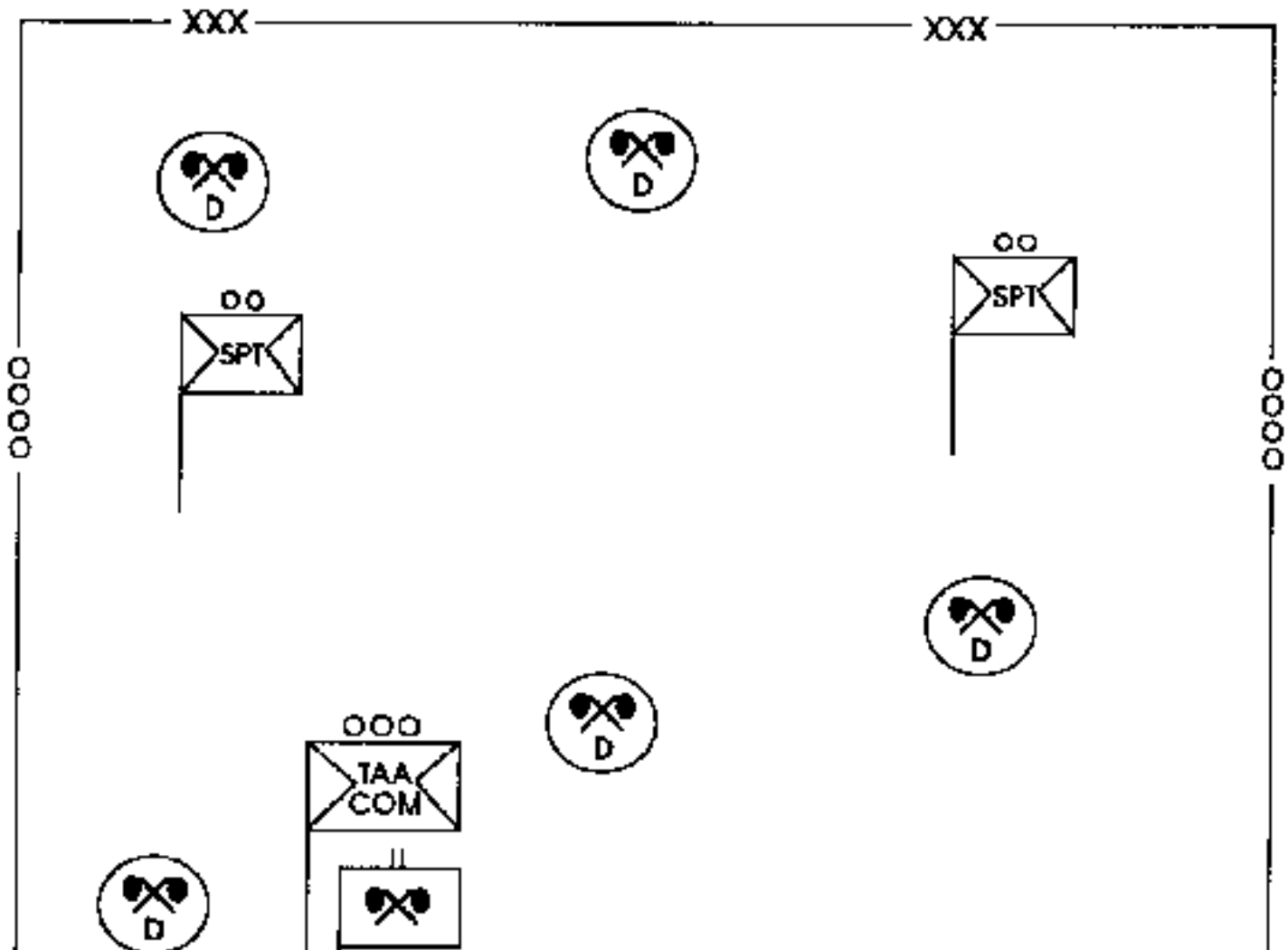

Figure 9-1. Area support mission.



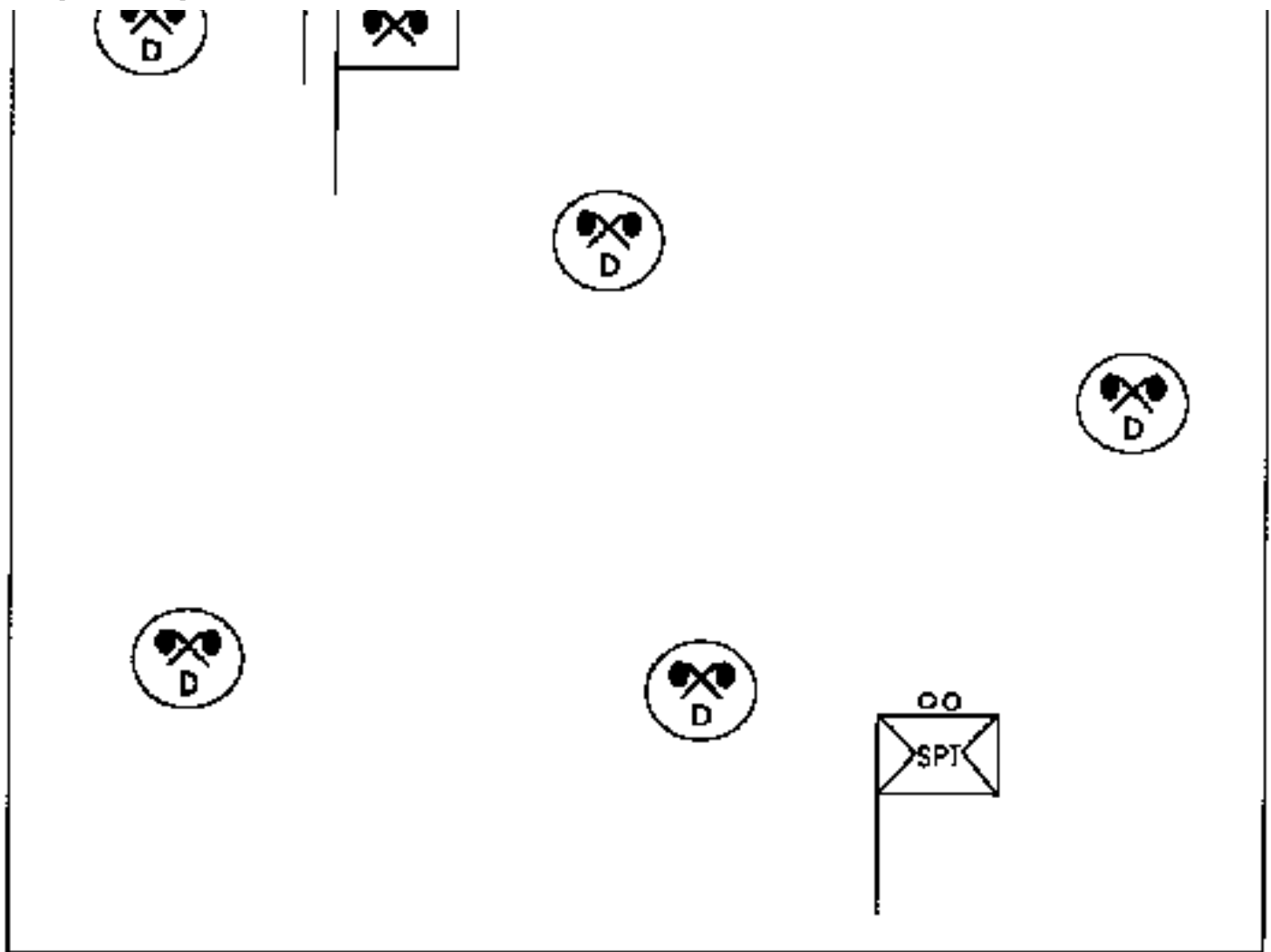

Figure 9-2. Task oriented support.

## CORPS AND DIVISION REAR

### Chemical Brigade

Depending on the corps mission and the NBC threat to the rear area, chemical units will be allocated to support units in the corps rear area. The allocation of a chemical battalion HHD to provide command and control of chemical support in the corps rear area is dependent on the number of chemical companies committed to rear area support. The chemical units supporting the rear area would be in general support (GS). However, their workload is also designated, like the TAACOM chemical assets, through area or task assignments. Requests for immediate chemical support flow through the corps rear CP to the chemical brigade. The chemical brigade TOC then directs the mission or tasking to the appropriate chemical unit. Routine chemical support requests go to the corps chemical section. The corps chemical section analyzes the requirement. The corps G3 assigns a priority to the

requirement. The prioritized requirement is passed to the chemical brigade TOC. The chemical brigade staff determines the allocation of support necessary to provide the support and issues instructions to the appropriate subordinate unit.

If a chemical battalion HHD is not providing command and control in the rear area, the chemical brigade does. If beyond the chemical brigade's ability, place these chemical assets in direct support of the corps support groups.

## **Chemical Battalion**

The chemical battalion with command and control of the corps rear area has a challenging mission. The battalion staff must analyze the assigned missions/tasks and develop a feasible support plan. The battalion may place the subordinate chemical units in general support and provide mission or task assignments or place the subordinate elements in a direct support role. The area of responsibility, the threat, and the ability to communicate will dictate which technique to use. The battalion, depending on METT-T, may task organize the subordinate companies to form chemical company teams.

Chemical battalions supporting divisions must plan and execute chemical support operations in the division rear area. Units requiring immediate chemical support will request it through their higher headquarters, usually one of the division's major subordinate commands (DISCOM, DIVARTY, aviation brigade, or separate battalions) to the division chemical section. The division chemical section analyzes the requirement and makes a recommendation to the division G3. The G3 assigns the mission/task to the chemical battalion for execution. Routine support requests are passed to the division chemical section. The chemical section will analyze and coordinate with G3 Plans to determine future requirements. Based on recommendations by the division chemical officer, the division commander issues guidance. The battalion commander executes the commander's guidance and the division chemical section provides staff supervision.

## **Chemical Companies**

The chemical companies may support rear operations in the TAACOM, corps, or division rear areas. Decontamination may be more complex involving CSS vehicles, supplies, and materials. It may be necessary to

conduct limited terrain or fixed site decontamination. Host nation support may be required.

## **Chemical Staff Considerations**

- Conduct an NBC IPB to determine the NBC threat to the rear area.
- Conduct a vulnerability analysis and provide recommendations to lessen vulnerability.
- Clarify NBCWRS chain and chemical support request channels.
- Identify decon sites to support all rear operations.
- Plan and coordinate NBC recon effort with the PMO to avoid duplication.
- Identify and request host nation support.
- Understand the host nation NBCWRS.

[RDL](#)[Table of](#)[Document](#)[Download](#)[Homepage](#) [Contents](#) [Information](#) [Instructions](#)

---

## CHAPTER TEN

# SUSTAINMENT OPERATIONS

## CONCEPT

Adequate CSS is vital to any combat operation. Sustainment operations must have the same emphasis in planning, preparation, and execution as the operational aspects.

Chemical units at all levels require extensive logistical support. Smoke and decontamination operations are resource-intensive operations that require detailed logistical planning and execution to ensure success.

When planning the employment of chemical assets, the commander must balance the requirements against limited resources. The challenge is to accomplish the mission within resource constraints. Logistical considerations will have as much impact on courses of actions as the enemy does.

## LOGISTIC CHARACTERISTICS

### ANTICIPATION

Foresee future operations as accurately as possible and accumulate assets needed to accommodate any likely contingency. Chemical operations feature high consumption rates of fuel, fog oil, decontaminants, and water. They require a commitment of maintenance, transportation, food, and medical services.

### INTEGRATION

Integrate CSS into tactical and operational plans. The logistic

capabilities of the force will affect the feasibility of a concept of operations.

## **CONTINUITY**

Maintain continuous supplies and services. Chemical units are always committed to either the current battle or preparing for the next. They need a constant flow of supplies, personnel, and services to remain productive. Consider how chemical units will receive their logistical support as they operate on the battlefield. Recognize that sudden or rapid changes in task organizations will affect the continuity of logistical support to them.

## **RESPONSIVENESS**

React rapidly to crises or fleeting opportunities. The logistic system must keep pace with the shifting of chemical units around the battlefield. The logistic system must respond when chemical units are executing their support mission. Thorough decontamination operations cannot be conducted unless the logistic system provides support and assistance.

## **IMPROVISATION**

Improvise to meet unforeseen emergencies. The success of the logistic system heavily influences the extent to which chemical units also must improvise.

## **SUPPORT FOR CHEMICAL UNITS**

The manner in which the CSS system supports a particular chemical unit depends upon that the unit's parent organization, its location in the theater of operations, and the command or support relationship under which it is operating. The wide array of possibilities presents a considerable challenge to the logistical planner responsible for that unit. Low density and unique equipment and personnel increase this challenge. Meeting this challenge ensures that the unit remains capable of performing its mission. The 63-series FMs give the specific details of how the organizations provide combat service support.

## **ECHELONS**

CSS organizations provide sustainment support to chemical units at each echelon.

## **Theater Army**

The theater army (TA) receives and moves personnel, supplies, and equipment to the combat zone and sustains its own units operating in the COMMZ. The theater army area command (TAACOM) is the major logistical and support organization in the TA. If the TA has a large geographical area of responsibility, more than one TAACOM will be established. Within the TAACOM, support is provided by area support groups (ASG). Chemical units operating in the COMMZ will normally be subordinate to the TAACOM and receive logistical support from an ASG. Logistical support is coordinated through the TAACOM headquarters.

## **Corps**

The COSCOM sustains the corps' chemical units, including those deployed in the division areas. However, when corps chemical units operate too far forward in the division area for effective COSCOM support, the division must assume responsibility. COSCOM units will habitually locate near the division rear boundary and in the division area itself to provide responsive support to those units operating in the division rear. Corps support groups (CSG) provide maintenance, supply, and field services on an area basis. Health service support is provided by the corps medical brigade/group.

## **Division**

The DISCOM sustains the divisional units through forward support battalions (FSB) in direct support to each maneuver brigade and the main support battalion (MSB) to units in the division rear. The division chemical company will receive support from the closest DISCOM unit. The division chemical officer will coordinate logistical support for the division chemical company with the G4. When the division is supported by corps chemical units, the DISCOM is augmented by the COSCOM.

## **Brigade**



The DISCOM provides CSS elements in the brigade support area (BSA) to sustain the brigade. Divisional chemical elements receive their support through the BSA, but must coordinate for this support. Corps chemical units will not be supported without prior coordination.

## **SUPPORT FOR CHEMICAL SUPPORT OPERATIONS**

### **DECONTAMINATION OPERATIONS**

Decontamination operations require significant logistical support for both the decon and the contaminated unit(s), such as medical, engineer, MP, maintenance, quartermaster, and transportation.

The decon unit requires engineer support to prepare thorough decon sites. MPs are used for traffic control and to a limited extent, security of the site. Supporting logistic activities (FSB, MSB, CSG, or ASG) push water forward if a local water source is not available. Additional decontaminants may be required, depending on the type and amount of contaminated vehicles/equipment. Decon platoons have limited water and cargo haul capability.

The contaminated unit requires extensive logistical support. A medical treatment capability supports the decon site. Maintenance, quartermaster, and transportation elements are positioned to assist the contaminated units to return to fully mission capable.

### **SMOKE OPERATIONS**

Smoke operations require detailed logistical planning. Planners determine the amount of fog oil and POL necessary for the operation. Divisional smoke platoons are unable to carry more than an operational load of fog oil. Corps smoke companies have an organic fuel support platoon. Large smoke operations over two hours or back-to-back smoke missions will require logistical support beyond that organic to the chemical unit.

There are several techniques to provide continuous support. One technique is forward positioning of supplies (fog oil, ammunition, and POL). A location for the smoke forward fuel point (SFFP) is determined and supplies are moved forward by transportation assets or the unit itself. The smoke unit moves to the propositioned supplies as

necessary. The quantity of fog oil and other supplies stocked at the SFFP is based on the amount needed to support the mission plus one basic load for the smoke unit. This allows the smoke unit to be fully mission capable after the operation. Another technique is to configure push packages and position them at the nearest logistics support activity (FSB, CSG, or ASG). This activity would push the package forward to a predetermined point. If no transportation support is available, decon units can transport supplies forward to the smoke units. The supported unit may be able to provide POL support.

## **NBC RECONNAISSANCE OPERATIONS**

NBC reconnaissance units do not consume large amounts of supplies during their missions. However because of the specialized nature of their equipment, particularly the M93 NBCRS (Fox), consideration must be given to the maintenance needs of the unit. Additionally, NBC recon units tend to operate at the team and squad level thus requiring logistical support from the supported unit.

## **NBC DEFENSE OPERATIONS**

Chemical staffs must consider the impact of NBC defense operations on logistics. The decision to initiate MOPP creates a tremendous burden on the logistics system to keep soldiers in serviceable MOPP gear. The chemical staff must work closely with the G4/S4 to resolve any chemical defense equipment critical shortfalls,

## **STAFF PLANNING, COORDINATION, AND SUPERVISION**

Planning for sustainment operations begins with a warning order from higher headquarters. At this point, logistical needs for the operation are determined. The logistics planner develops an estimate of each unit's in as much detail as possible, and provides that information to the G4/S4.

Once the planning is done, the chemical unit logisticians coordinate the details needed to make the logistics support effective.

As units execute the plan, the logisticians track the status of their units and missions. They solve CSS problems that threaten the successful completion of missions and tasks. Combat losses and

breakdowns continuously force adjustments to the original plan.

## **SUSTAINMENT OPERATIONS AT THE COMPANY LEVEL**

The techniques of resupplying subordinate platoons are situationally dependent. The command or support relationship of the platoons also will dictate the level of support required from the company.

The most efficient resupply technique is by logistical packages (LOGPACs). The LOGPAC is organized by the chemical company supply sergeant at the supporting logistics activity under the supervision of the company first sergeant. The LOGPAC moves from the logistical support activity to predetermined points (logistic release points - LRPs). The platoons meet the LOGPAC at their designated LRP and guides it to their platoon position.

Another technique is to cache supplies on the battlefield and direct platoons to these supplies. This technique is useful for propositioning fog oil. The main disadvantage is that the supplies may be lost or overrun in a fluid tactical environment.



[RDL](#)



[Table of](#)



[Document](#)



[Download](#)

[Homepage](#) [Contents](#) [Information](#) [Instructions](#)

---

## APPENDIX A

# CHEMICAL UNIT ORGANIZATIONS

This appendix provides the mission, capabilities, and major equipment of chemical organizations to assist commanders and staffs in effectively using chemical units. The organizations and equipment depicted in this appendix are extracted from tables of organization and equipment (TOEs) and are current as of 10 June 1993. Modified tables of organization and equipment may be slightly different.

## SECTION I

## Unit Type, Assignment, and Allocation Data

UNIT	TOF	NORMAL ASSIGNMENT	NORMAL BASIS OF ALLOCATION	FORCE STRUCTURE	
				ACTIVE	RESERVE
HHC, CHEM BDE	03472L000	Corps	1 per corps		X
HHD, CHEM BN	03467L100	Corps	1 per 3-7 chem companies	X	
HHD, CHEM BN (ENHANCED)	03476L200	TAACOM	1 per 3-7 chem companies		X
CHEM CO (MECH SMK)	03437L000	Corps	1 per heavy division	X	X
CHEM CO (MOTOR SMK)	03447L000	Corps	4 per corps (NATO) 5 per corps (SWA) 4 per corps (NEA)		X
CHEM CO (DECON)	03417L000	Corps TAACOM	1 per heavy division (NATO/ NEA) 1 per division (SWA) 2 per corps (NATO) 1 per corps (SWA) 2 per TAACOM 3 per TA (NATO)	X	X
CHEM CO (SMK/DECON)	03467L000	Corps	1 per heavy division 1 per light division 6 per corps	X	X
CHEM CO (SMK/DECON)	03457L000	Corps	1 per light div	X	X
CHEM CO (RECON)	03427L000	Corps TAACOM	1 per TA & corps		X
CHEM CO (HVY DIV) (AC)	03157L200	Armored Div Mech Inf Div	1 per heavy division	X	
CHEM CO (HVY DIV) (RC)	03157L100	Armored Div Mech Inf Div	1 per heavy division		X
CHEM CO (SMK/DECON)	03057L000	Airborne Div Assault Div	1 per airborne and assault division	X	
CHEM CO (SMK/DECON/ RECON)	03377L200	ACR	1 per ACR	X	X

UNIT	TOE	NORMAL ASSIGNMENT	NORMAL BASIS OF ALLOCATION	FORCE STRUCTURE	
				ACTIVE	RESERVE
CHEM CO (DECON/RECON)	03333L000	LACR	1 per LACR	X	
FA TEAM (DECON)	03518LA00	USASFC Sep Bde	1 per USASFC 3 per sep bde (Aleutians)	X	X
JA TEAM (NBCC)	03579LA00	Sep Bde Unified Cmd Corps TA Theater Def Bde	1 per sep bde 1 per Unified Cmd (SWA) 1 per corps 1 per TA (SWA) 1 per theater def bde	X	X
JB TEAM (NBCE)	03579LB00	ASG TAACOM Sep Bde USASFC	1 per ASG 1 per TAACOM 1 per sep bde (Iceland/Panama) 1 per USASFC	X	X
LA TEAM (RECON)	03529LA00	Sep Bde Theater Def Bde	1 per sep bde 1 per theater def bde		X
IR TEAM (RECON)(SF)	03579I B00	SF Group	1 per SF Group	X	X

## SECTION II

### ORGANIZATIONAL CHARTS

## CHEMICAL BRIGADE HEADQUARTERS & HEADQUARTERS COMPANY

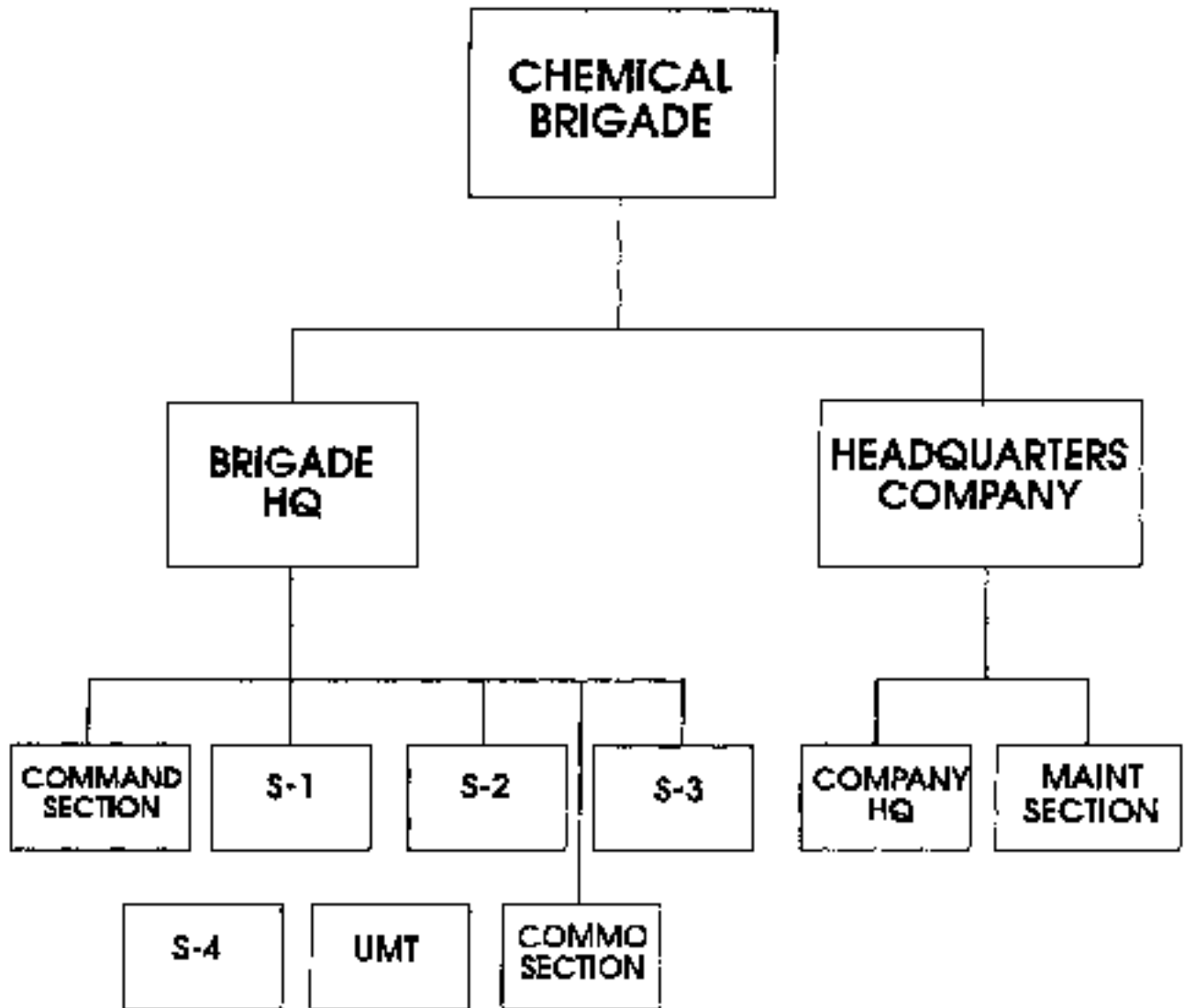

**TOE:** 03472L000

**MISSION:** To provide command and control of two to six chemical battalions.

**PERSONNEL:** 17 officers, 1 warrant officer, 47 enlisted

**MAJOR EQUIPMENT SYSTEMS:**

- 5 HMMWVs, M998/1038
- 1 HMMWVs, M1028
- 2 Trucks, cargo, 2 1/2-ton
- 3 CUCVs, 3/4-ton, M1009
- 3 Trailers, 3/4-ton
- 1 Trailer, 1 1/2-ton
- 1 Radio set, AN/GRC-106 (AN/GRC-193)

- 2 Radio sets, AN/VRC-47 (AN/VRC-89)
- 1 Generator set, 3kw
- 1 Generator set, 5kw
- 1 Generator set, 5kw (PU-160)
- 3 Chemical alarms, M8A1

## CHEMICAL BATTALION HEADQUARTERS AND HEADQUARTERS DETACHMENT

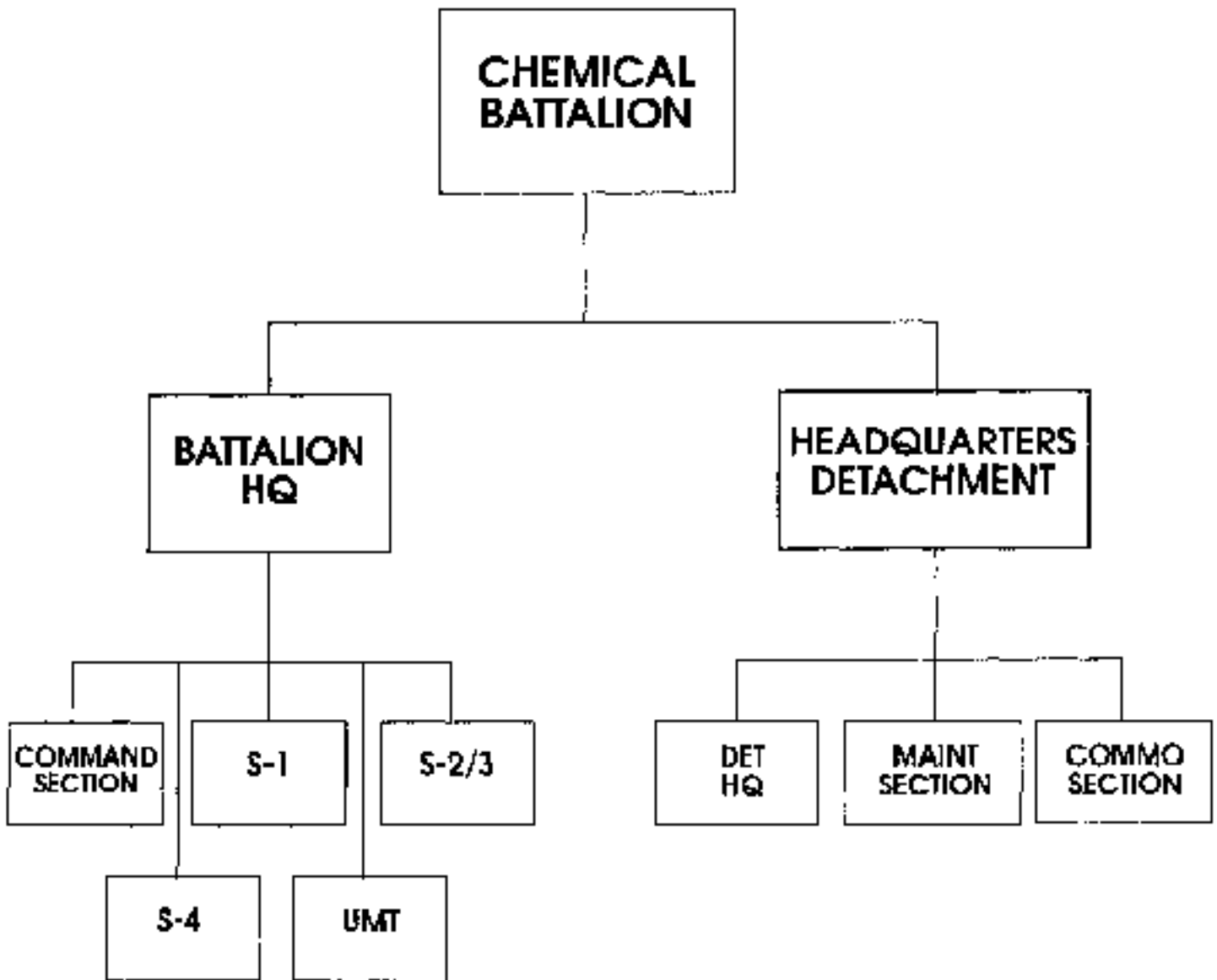

TOE: 03476L100

**MISSION:** To provide command and control of three to seven chemical companies (reconnaissance, decontamination, dual purpose [smoke/decon], mechanized smoke, and/or motorized smoke).

**PERSONNEL:** 10 officers, 7 warrant officers, 37 enlisted

**MAJOR EQUIPMENT SYSTEMS:**

- 4 HMMWVs, M998/1038
- 3 Trucks, cargo, 2 1/2-ton
- 7 CUCVs, 3/4-ton, M1009
- 4 Trailers, 3/4-ton
- 3 Trailers, 1 1/2-ton
- 1 Water trailers, 400-gal

- 1 Generator set, 3kw
- 2 Generator sets, 5kw
- 3 Chemical alarms, M8A1



- 3 Trailers, 1 1/2-ton
- 1 Water trailers, 400-gal
- 1 Radio set, AN/GRC-160, (AN/GRC-88)
- 7 Radio sets, AN/VRC-46, (AN/VRC-90)
- 1 Radio set, AN/VRC-47, (AN/VRC-89)

## CHEMICAL BATTALION HEADQUARTERS AND HEADQUARTERS ( ENHANCED )

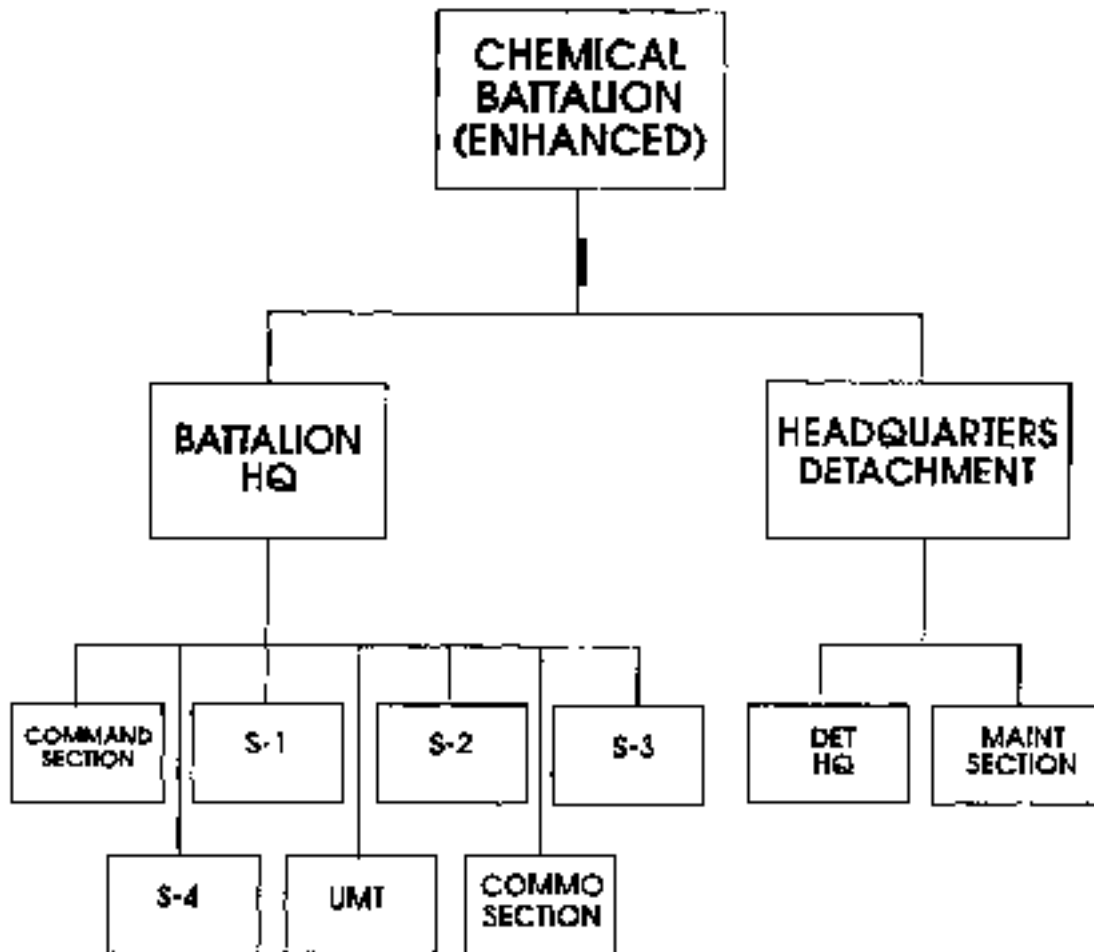

FOE: 03476L200

**MISSION:** To provide command and control of two to five chemical companies (reconnaissance, decontamination, dual purpose {smoke/decon}, mechanized smoke, and/or motorized smoke).

**PERSONNEL:** 12 officers, 2 warrant officers, 43 enlisted

**MAJOR EQUIPMENT SYSTEMS:**

- 4 HMMWVs, M998/1038
- 3 Trucks, cargo, 2 1/2-ton
- 7 CUCVs, 3/4-ton, M1009
- 3 Trailers, 3/4-ton

- 7 Trucks, cargo, 5-ton
- 7 CUCVs, 3/4-ton, M1009
- 3 Trailers, 3/4-ton
- 3 Trailers, 1 1/2-ton
- 7 Radio sets, AN/GRC-160 (AN/GRC-88)
- 1 Radio set, AN/VRC-46 (AN/VRC-90)
- 1 Generator set, 3kw
- 1 Generator set, 5kw
- 1 Generator set, 5kw (PU-620)
- 3 Chemical alarms, M8A1

**CHEMICAL COMPANY (SMOKE GENERATOR) (MECHANIZED)**

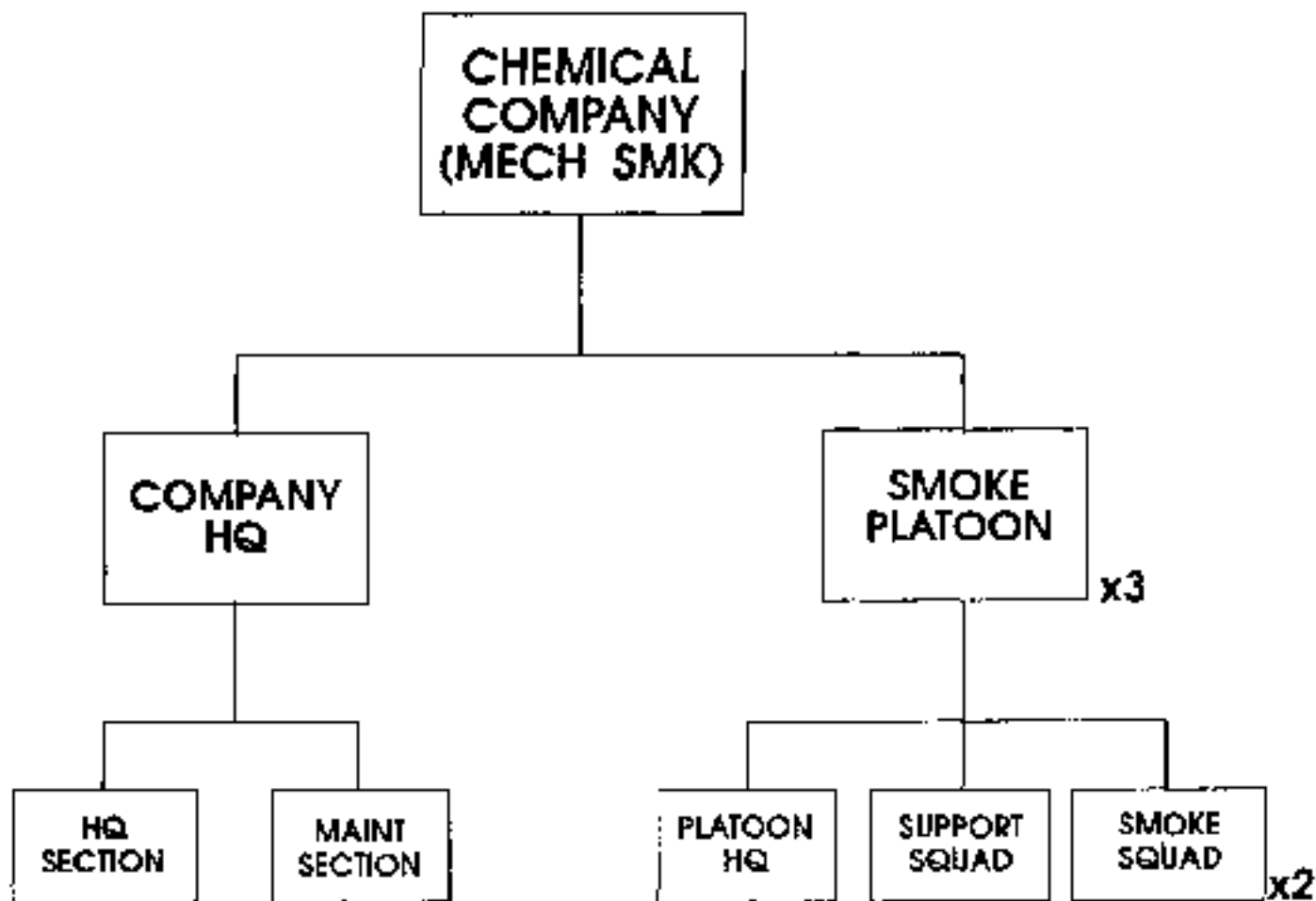

TOE: 03437L000

**MISSION:** To provide large-area smoke support for a heavy division from the main battle area forward.

**PERSONNEL:** 5 officers, 0 warrant officer, 102 enlisted

**MAJOR EQUIPMENT SYSTEMS:**

7 Trucks, cargo, 5-ton

28 Machineguns, .50 cal

- 7 Trucks, cargo, 5-ton
- 1 Truck, wrecker, 5-ton
- 4 Trucks, cargo, 2 1/2-ton
- 5 HMMWVs, 5/4-ton
- 2 Trailers, 1/4-ton
- 9 Trailers, 1 1/2-ton
- 1 Water trailer, 400-gal
- 7 trailer-mounted TPU
- 7 Tank and pump units
- 3 Radio sets, AN/VRC-46 (AN/VRC-90)
- 5 Radio sets, AN/VRC-47 (AN/VRC-89)
- 1 Generator set, 5kw
- 12 Chemical alarms, M8A1
- 21 M1059 carriers, smoke generator
- 1 M578 recovery vehicle, tracked, light

28 Machineguns, .50 cal

**CHEMICAL COMPANY (SMOKE GENERATOR) (MOTORIZED)**

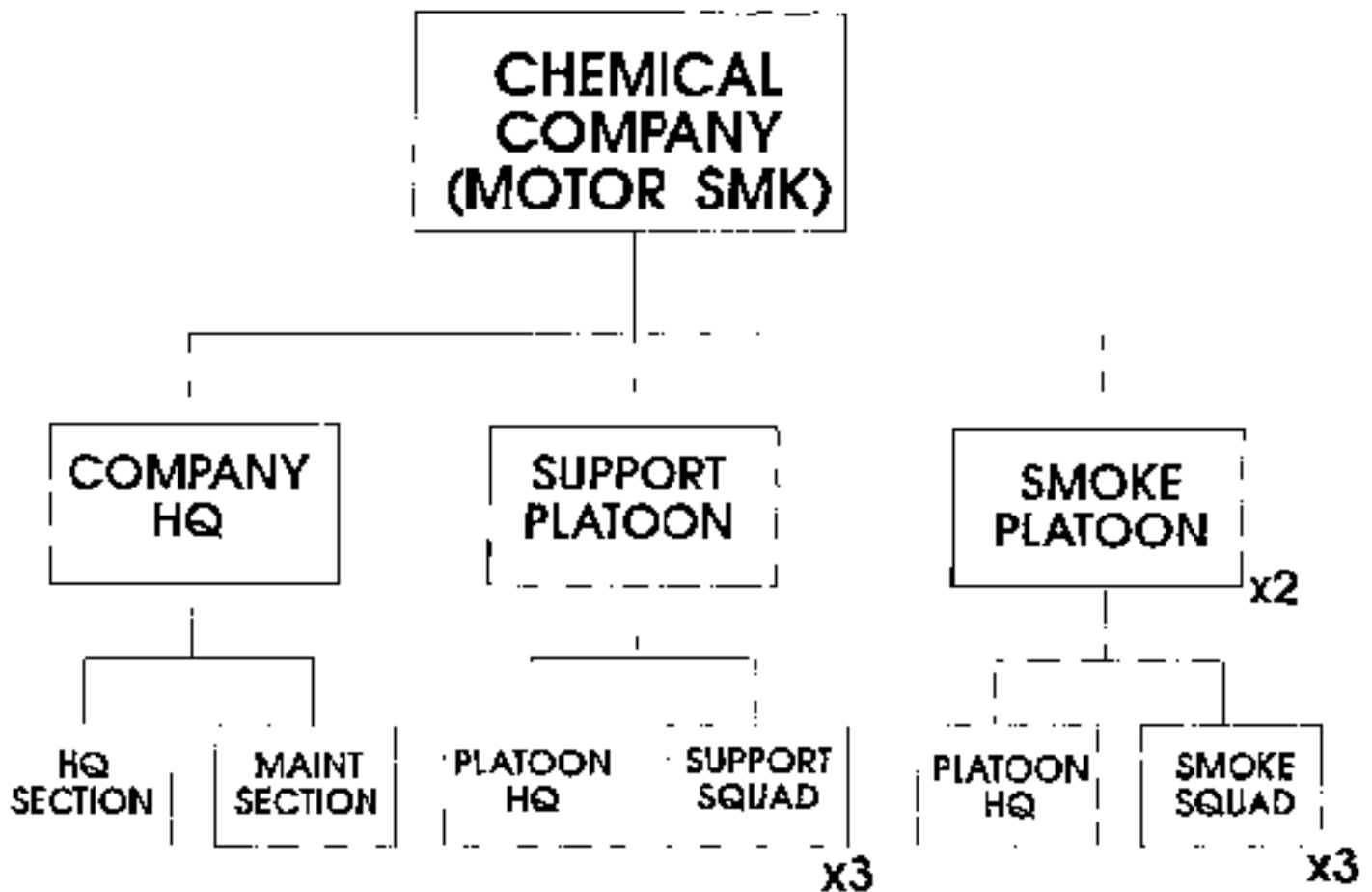

TOE: 03447L000

**MISSION:** To provide large-area smoke support for elements of a corps/theater army,

**PERSONNEL:** 5 officers, 0 warrant officer, 130 enlisted

**MAJOR EQUIPMENT SYSTEMS:**

- |                                      |                            |
|--------------------------------------|----------------------------|
| 10 Trucks, cargo, 5-ton              | 24 M 167 smoke generators  |
| 1 Truck, wrecker, 5-ton              | 9 Machineguns, .50 cal     |
| 3 Trucks, cargo, 2 1/2-ton           | 28 Machineguns, 7.62mm M60 |
| 38 HMMWVs, 5/4-ton                   |                            |
| 2 CUCVs, 3/4-ton, M1 009             |                            |
| 1 Truck, 5/4-ton, w/commo            |                            |
| 38 Trailers, 3/4-ton                 |                            |
| 1 Trailer, 1 1/2-ton                 |                            |
| 1 Water trailer, 400-gal             |                            |
| 11 Tank and pump units               |                            |
| 12 Radio sets, AN/VRC-46 (AN/VRC-90) |                            |
| 4 Radio sets, AN/VRC-47 (AN/VRC-89)  |                            |
| 2 Generator sets, 3kw                |                            |
| 5 Chemical alarms, M8A1              |                            |

**CHEMICAL COMPANY (DECON)(CORPS/TA)**

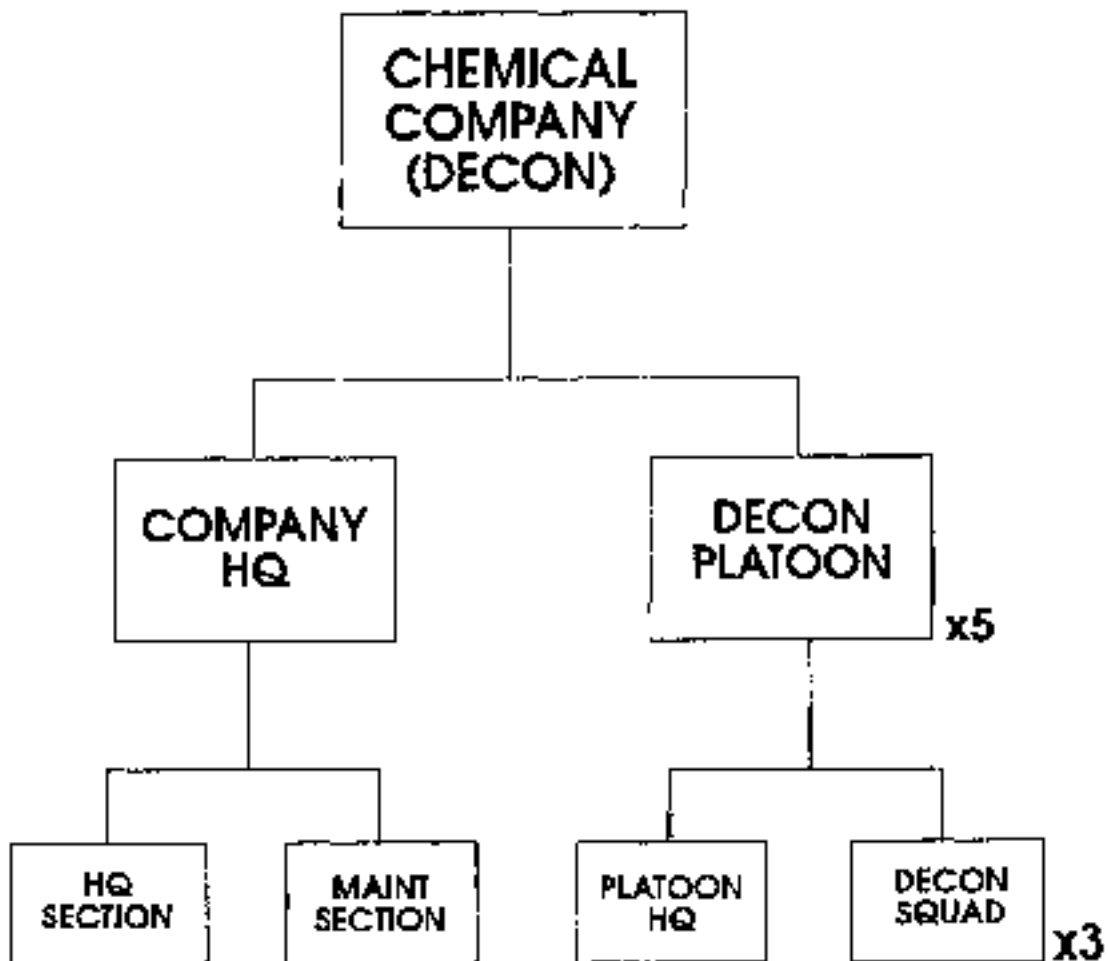

TOE: 0341 7L000

MISSION: Provide decontamination support for elements of corps/theater army.

PERSONNEL: 7 officers, 0 warrant officer, 127 enlisted

**MAJOR EQUIPMENT SYSTEMS:**

31 Trucks, cargo, 5-ton	2 Generator sets, 3kw
1 Truck, wrecker, 5-ton	21 Chemical alarms, M8A1
18 Trucks, cargo, 2 1/2-ton	15 M12A1 decontaminating apparatuses
2 Trucks, 5/4-ton, w/commo	16 Machineguns, 7.62mm M60
6 CUCVs, 3/4-ton, M1 009	
6 Trailers, 1/4-ton	
47 Trailers, 1 1/2-ton	
1 Water trailer, 400-gal	
15 Tanks, fabric, water, 500-gal	
15 Tanks, fabric, water, 3,000-gal	
1 Trailer-mounted TPU	
16 Tank and pump units	
45 65gpm pumps	
15 Radio sets, AN/GRC-160, (AN/GRC-88)	
3 Radio sets, AN/VRC-46, (AN/VRC-90)	
6 Radio sets, AN/VRC-47, (AN/VRC-89)	

**CHEMICAL COMPANY (SMOKE/DECON)(CORPS/TA)**

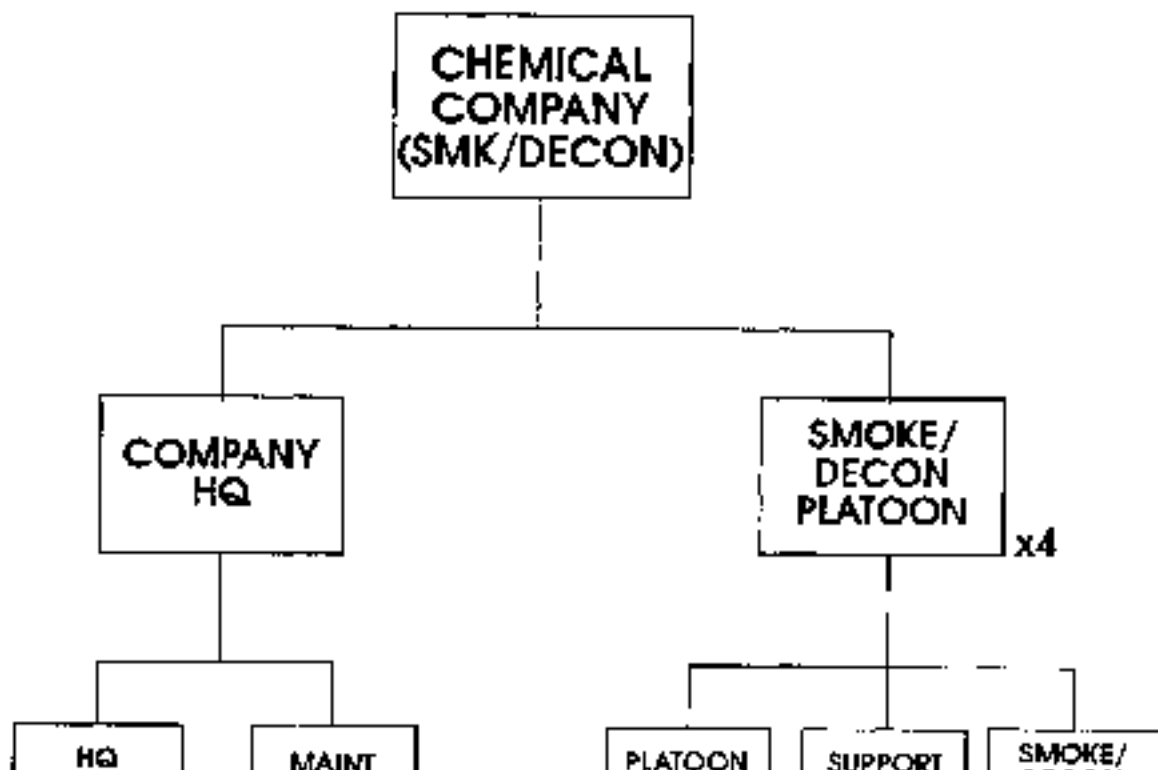



TOE: 03467L000

MISSION: To provide equipment decontamination and large-area smoke support for elements of a corps/theater army.

PERSONNEL: 6 officers, 0 warrant officer, 135 enlisted

MAJOR EQUIPMENT SYSTEMS:

- 26 Trucks, cargo, 5-ton
- 3 Trucks, cargo, 2 1/2-ton
- 24 HMMWVs, 5/4-ton, (armored)
- 24 Trailers, 3/4-ton
- 20 Trailers, 1 1/2-ton
  - 1 Water trailer, 400-gal
- 10 Tank and pump units
  - 2 Trailer-mounted tank and pump units
- 11 Radio sets, AN/VRC-46 (AN/VRC-90)
- 5 Radio sets, AN/VRC-47 (AN/VRC-89)
- 2 Generator sets, 3kw
- 13 Chemical alarms M8A1
  - 8 Tanks, fabric, 3,000 gal
  - 4 AN/VRC-98
- 28 Pumps, 65gpm
- 24 Generators, smoke, mechanical, M 157
- 24 decon apparatuses, lightweight

**CHEMICAL COMPANY (SMOKE/DECONTAMINATION)(CORPS)**

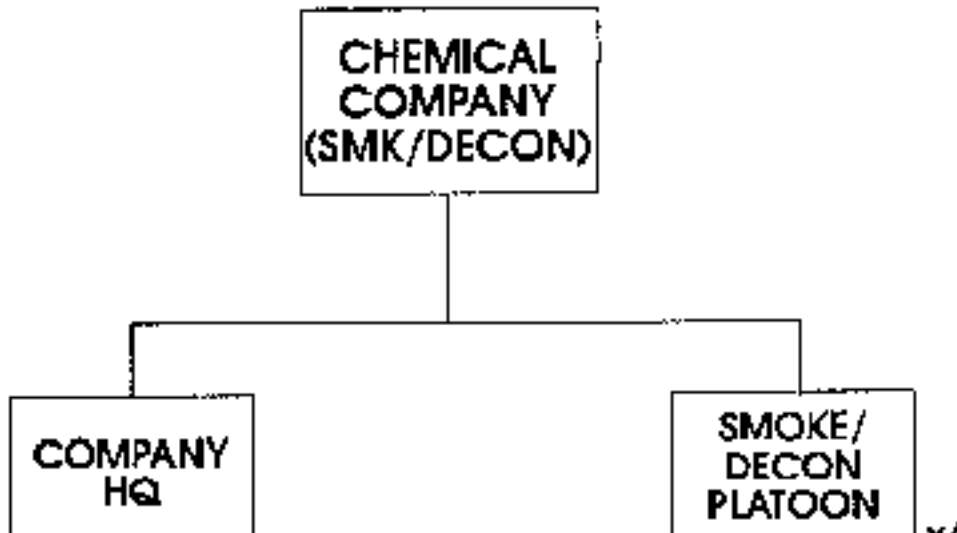

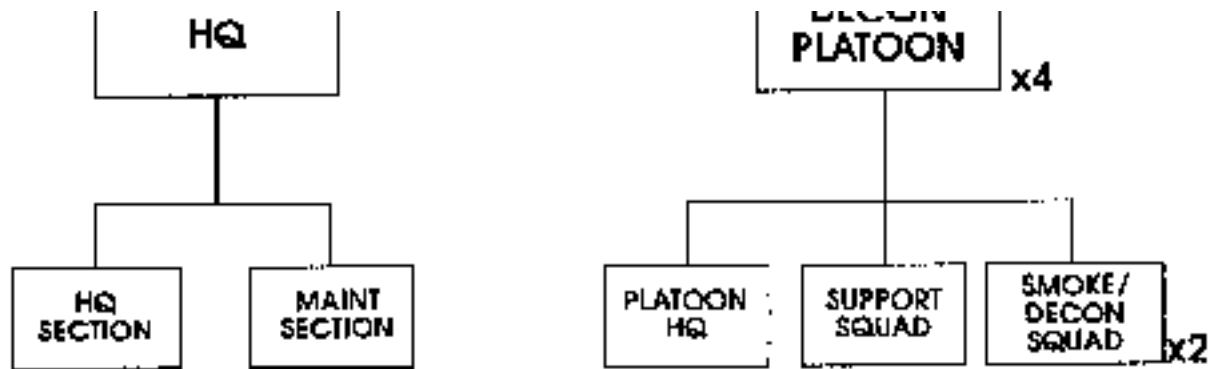

TOE: 03457L000

MISSION: To provide equipment decontamination and large-area smoke support for a light division.

PERSONNEL: 6 officers, 1 warrant officer, 149 enlisted

#### MAJOR EQUIPMENT SYSTEMS:

- 37 Trucks, cargo, 5-ton
- 1 Truck, wrecker, 5-ton
- 31 HMMWVs, 5/4-ton
- 31 Trailers, 3/4-ton
- 28 Trailers, 1 1/2-ton
  - 1 Water trailer, 400-gal
  - 1 Trailer-mounted tank unit
- 8 Tanks, fabric, water, 3,000-gal
- 6 Tank and pump units
- 15 Radio sets, AN/VRC-46 (AN/VRC-90)
- 5 Radio sets, AN/VRC-47 (AN/VRC-89)
- 28 65gpm water pumps
- 2 Generator sets, 3kw
- 21 Chemical alarms, M8A1
- 24 M 157 smoke generators
- 26 Machineguns, 7 62mm,
- 8 M12A1 PDDAs

## CHEMICAL COMPANY (RECONNAISSANCE)

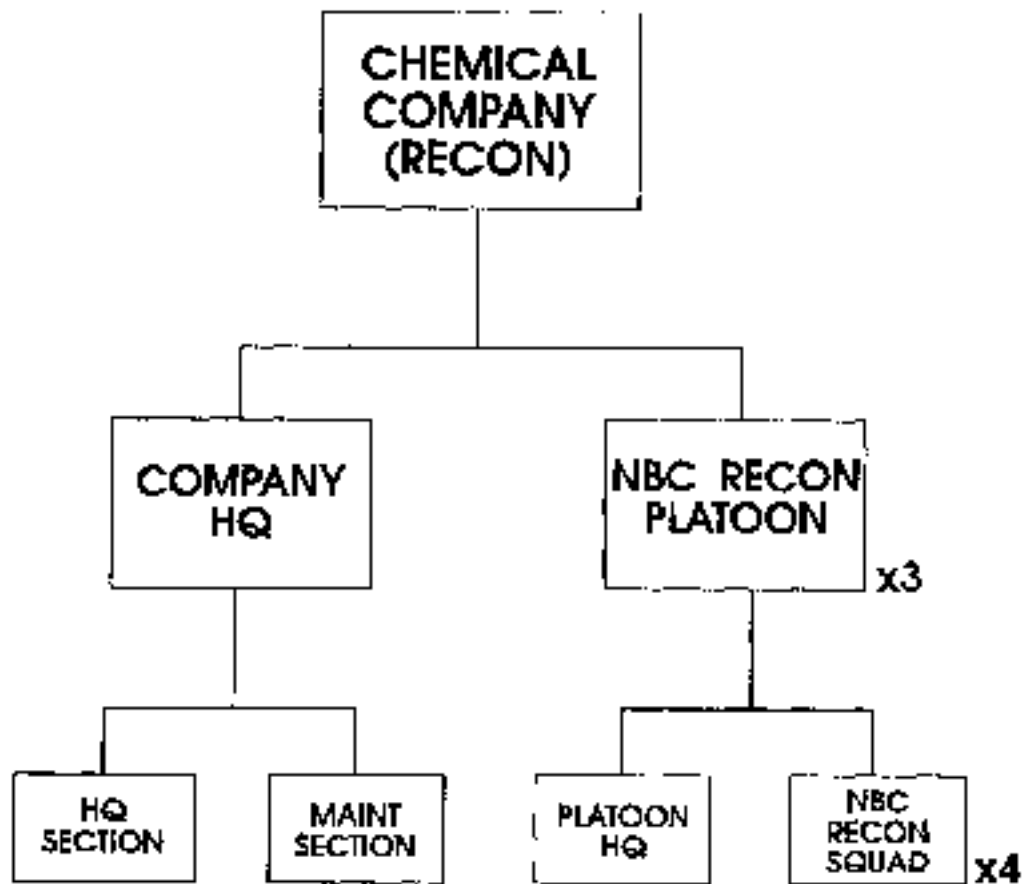

TOE: 03427L000

MISSION: To provide NBC reconnaissance support for elements of a corps/theater army.

PERSONNEL: 5 officers, 0 warrant officer, 137 enlisted

### MAJOR EQUIPMENT SYSTEMS:

- 1 Truck, cargo, 5-ton
- 4 Truck, cargo, 2 1/2-ton
- 40 HMMWVs, 5/4-ton (armored)
- 1 CUCVs, 5/4-ton, M1 008
- 4 Trailers, 1 1/2-ton
- 1 Water trailer, 400-gal
- 1 Tank and pump units
- 1 Trailer-mounted tank and pump unit
- 38 Radio sets, AN/VRC-46 (AN/VRC-90)
- 4 Radio sets, AN/VRC-47 (AN/VRC-89)
- 2 Generator sets, 3kw
- 4 Chemical alarms, M8A1
- 38 Machineguns, 7.62mm, M60



## CHEMICAL COMPANY (HEAVY DIVISION) [ACTIVE COMPONENT]

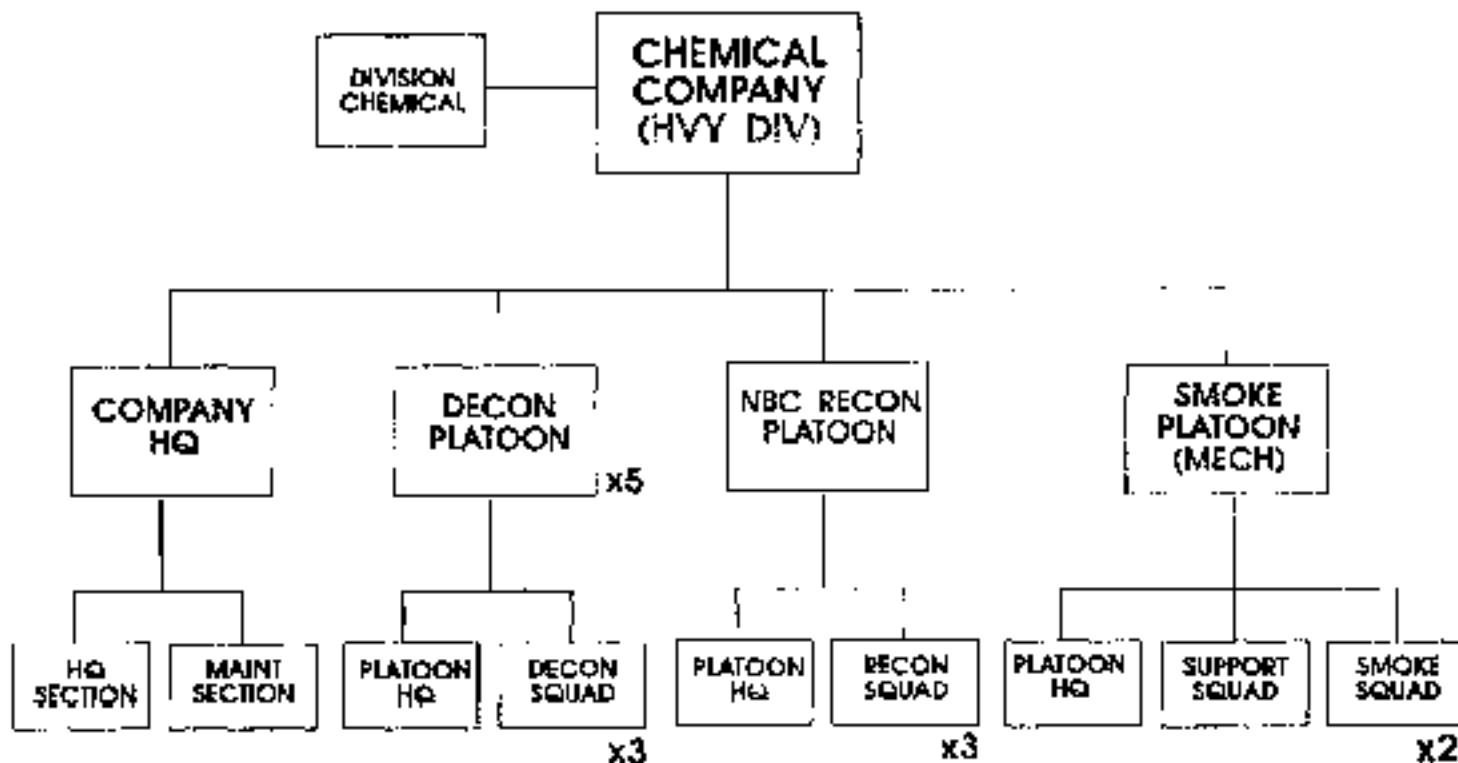

TOE: 03157L200

**MISSION:** To provide equipment decontamination, large-area smoke, NBC reconnaissance, NBC warning and reporting, and chemical staff support to a heavy/infantry division.

**PERSONNEL:** 12 officers, 1 warrant officer, 154 enlisted

### MAJOR EQUIPMENT SYSTEMS

27 Trucks, cargo, 5-ton	1 Recovery vehicle, tracked, light M578
15 Trucks, cargo, 2 1/2-ton	16 Radio sets, AN/VRC-46 (ANNRC-90)
6 HMMWVs, 5/4-ton	8 Radio sets, AN/VRC-47 (AN/VRC-89)
1 Truck, shop van, 2 1/2-ton	12 Radio sets, AN/GRC-160 (AN/VRC-88)
2 CUCVs, 3/4-ton	36 65gpm water pumps
1 HMMWV, with commo shelter	7 M105s, carrier, smoke generator
1 Truck, wrecker, 5-ton	6 M113 armored personnel carriers
1 Trailer, 3/4-ton	12 M12A1 PDDAs
41 Trailers, 1 1/2-ton	2 Generator sets, 3kw
1 Trailer, water, 400 gal	26 Chemical alarms, XM??

- 41 Trailers, 1 1/2-ton
- 1 Trailer, water, 400-gal
- 12 Tanks, fabric, water, 500-gal
- 12 Tanks, fabric, water, 3,000-gal
- 1 Trailer-mounted tank, liquid dispensing
- 15 Tank and pump units

- 2 Generator sets, 3kw
- 26 Chemical alarms, XM22
- 13 Machineguns, 7.62mm, M60
- 13 Machineguns, .50 cal

**CHEMICAL COMPANY (HEAVY DIVISION)**  
**[RESERVE COMPONENT]**

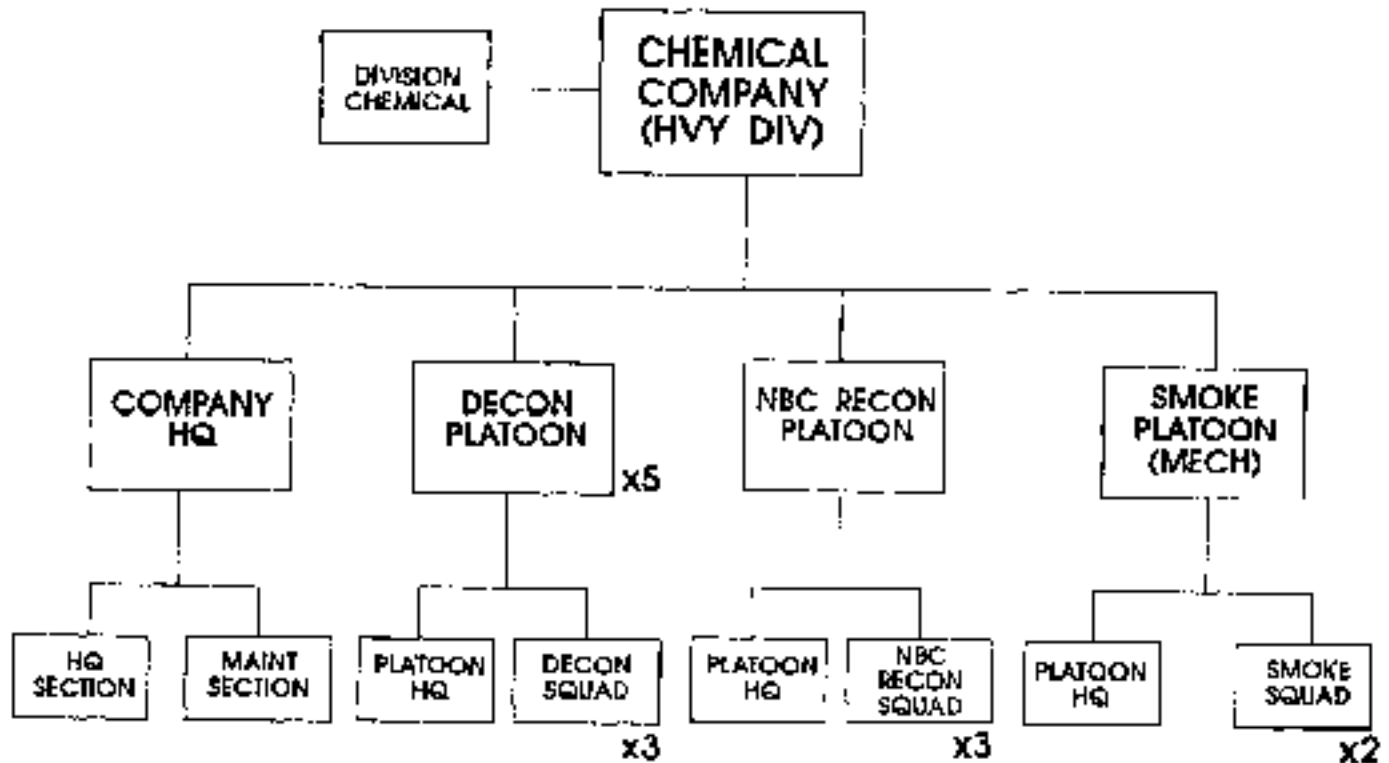

TOE: 03157L100

MISSION: To provide equipment decontamination, large-area smoke, NBC reconnaissance, NBC warning and reporting, and chemical staff support to a heavy/infantry division.

PERSONNEL: 12 officers, 1 warrant officer, 150 enlisted

**MAJOR EQUIPMENT SYSTEMS**

- 25 Trucks, cargo, 5-ton
- 15 Truck, cargo, 2 1/2-ton
- 6 HMMWVs, 5/4-ton
- 1 Truck, shop van, 2 1/2-ton
- 1 CUCV, 5/4-ton
- 2 CUCVs, 3/4-ton
- 1 HMMWVs with commo shelter
- 1 Trailer, 3/4-ton

- 14 Radio sets, AN/VRC-46 (AN/VRC-90)
- 8 Radio sets, AN/VRC-47 (AN/VRC-89)
- 12 Radio sets, AN/GRC-160 (AN/VRC-88)
- 36 65 gpm water pumps
- 6 M 1059s, carrier, smoke generator
- 6 M 113 armored personnel carriers
- 12 M12A1 PDDAs
- 2 Generator sets, 3kw

- 1 HMMWVs with commo shelter
- 1 Trailer, 3/4-ton
- 40 Trailers, 1 1/2-ton
- 1 Trailer, water, 400-gal
- 12 Tanks, fabric, water, 500-gal
- 12 Tanks, fabric, water, 3,000-gal
  - 1 Trailer-mounted tank, liquid dispensing
- 13 Tank and pump units
- 1 Recovery vehicle, tracked, light, M578

- 12 M12A1 PDDAs
- 2 Generator sets, 3kw
- 12 Chemical alarms, M8A1
- 13 Machineguns, 7.62mm, M60
- 12 Machineguns, .50 cal

## CHEMICAL COMPANY (AIRBORNE/AIR ASSAULT)

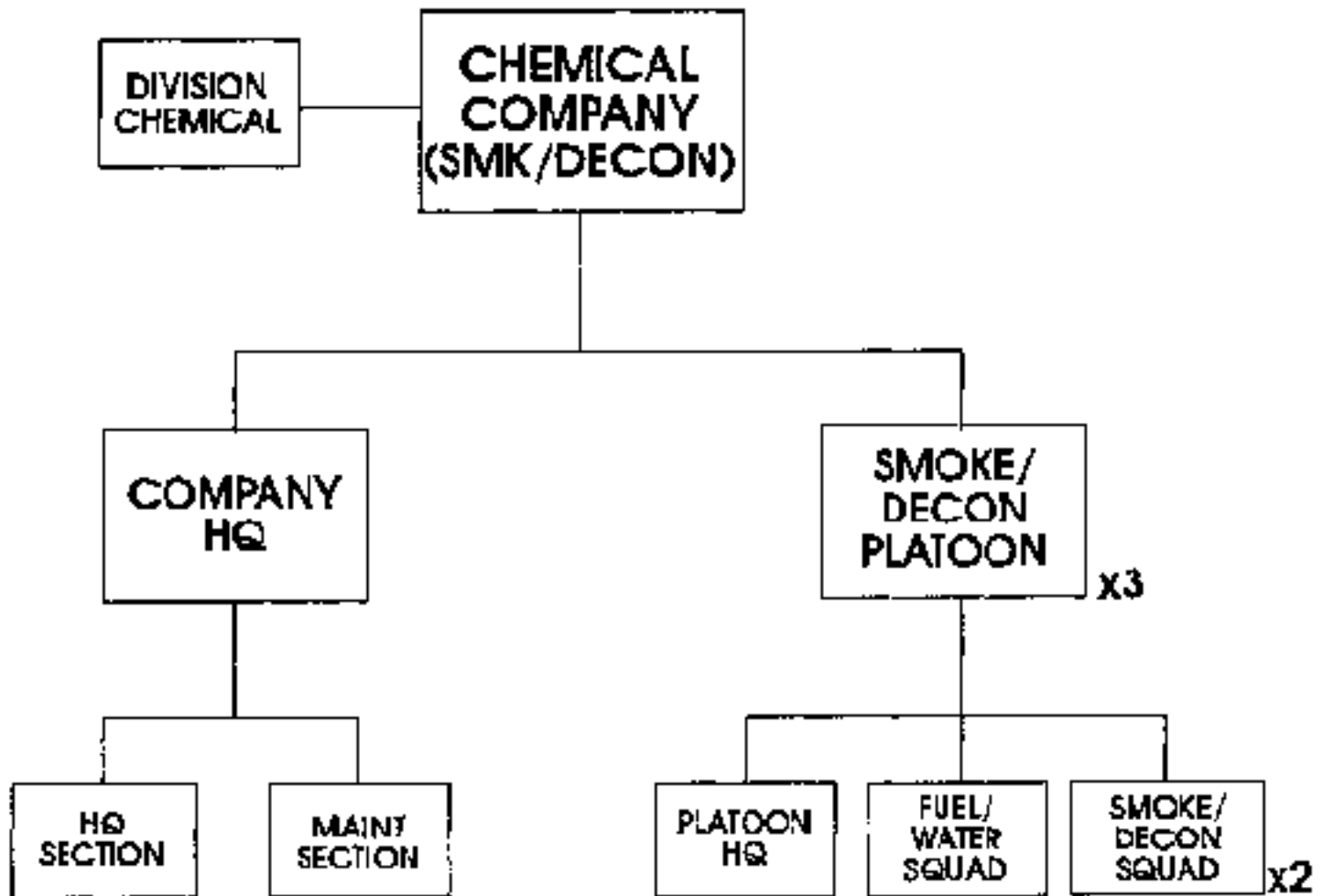

TOE. 03057 L000

**MISSION:** To provide equipment decontamination, large-area smoke, NBC reconnaissance, NBC warning and reporting, and chemical staff support for an airborne or air assault division

**PERSONNEL:** 9 officers, 1 warrant officer, 118 enlisted

**MAJOR EQUIPMENT SYSTEMS**

## MAJOR EQUIPMENT SYSTEMS

32 Trucks, cargo, 5-ton	21 65gpm water pumps
25 HMMWVs, 5/4-ton	18 M157s, smoke generator
1 Truck, wrecker, 5-ton	6 M12A1 PDEAs [18 M17 LDS]
2 CUCVs, 3/4-ton	2 Generator sets, 3kw
18 Trailers, 3/4-ton	17 Chemical alarms, M8A1
2 Trailers, 3/4-ton	20 Machineguns, 7.62mm, M60
22 Trailers, 1 1/2-ton	30 Drums, fabric, 500-gal
5 Tank, fabric, water, 500-gal	
5 Tank, fabric, water, 3,000-gal	
1 Trailer-mounted tank, liquid dispersing	
5 Tank and pump units	
12 Radio sets, AN/VRC-46 (AN/VRC-90)	
3 Radio sets, AN/VRC-47 (AN/VRC-89)	

### CHEMICAL COMPANY (SMOKE/DECONTAMINATION/RECONNAISSANCE)(ACR)

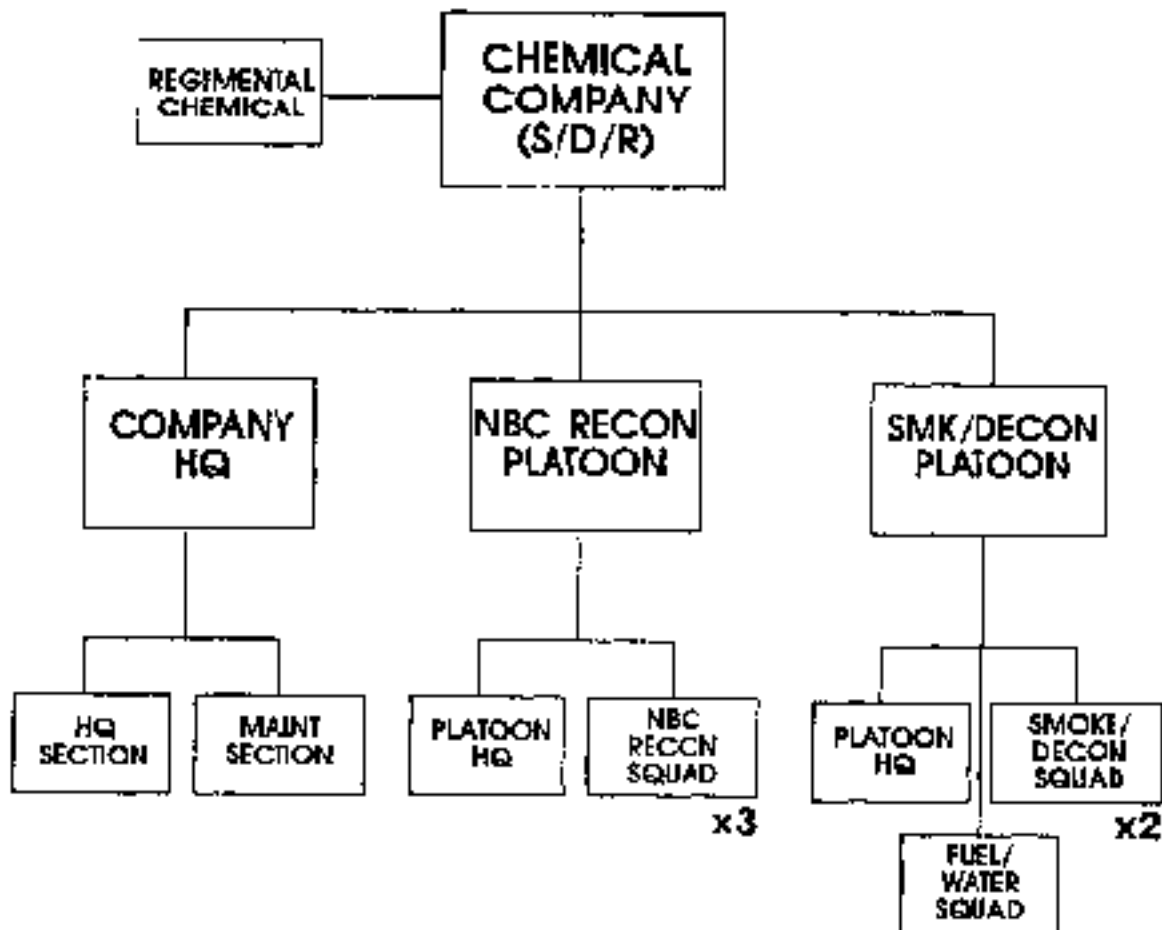

TOE: 03377L200

MISSION: To provide equipment decontamination, large-area smoke, NBC reconnaissance, NBC

MISSION: To provide equipment decontamination, large-area smoke, NBC reconnaissance, NBC warning and reporting, and chemical staff support for an armored cavalry regiment.

PERSONNEL: 6 officers, 0 warrant officer, 67 enlisted

MAJOR EQUIPMENT SYSTEMS:

- |                                      |                              |
|--------------------------------------|------------------------------|
| 4 Trucks, cargo, 5-ton               | 1 M12A1 PDDAs [3 - M17 PDDE] |
| 3 Trucks, cargo, 2 1/2-ton           | 1 Generator set, 5kw         |
| 4 HMMWVs, 5/4-ton                    | 11 Chemical alarms, M8A1     |
| 4 Trailers, 3/4-ton                  | 4 Machineguns, 7.62mm, M60   |
| 6 Trailers, 1 1/2-ton                | 12 Machineguns, .50 cal      |
| 2 Tanks, fabric, water, 500-gal      |                              |
| 1 Tank, fabric, water, 3,000-gal     |                              |
| 3 Tank and pump units                |                              |
| 14 Radio sets, AN/VRC-46 (AN/VRC-90) |                              |
| 4 Radio sets, AN/VRC-47 (AN/VRC-89)  |                              |
| 1 Radio sets, AN/GRC-160 (AN/VRC-88) |                              |
| 6 65gpm water pumps                  |                              |
| 7 M1059s, carrier, smoke generator   |                              |
| 6 M113 armored personnel carriers    |                              |

**CHEMICAL COMPANY  
(DECONTAMINATION/RECONNAISSANCE)(LACR)**

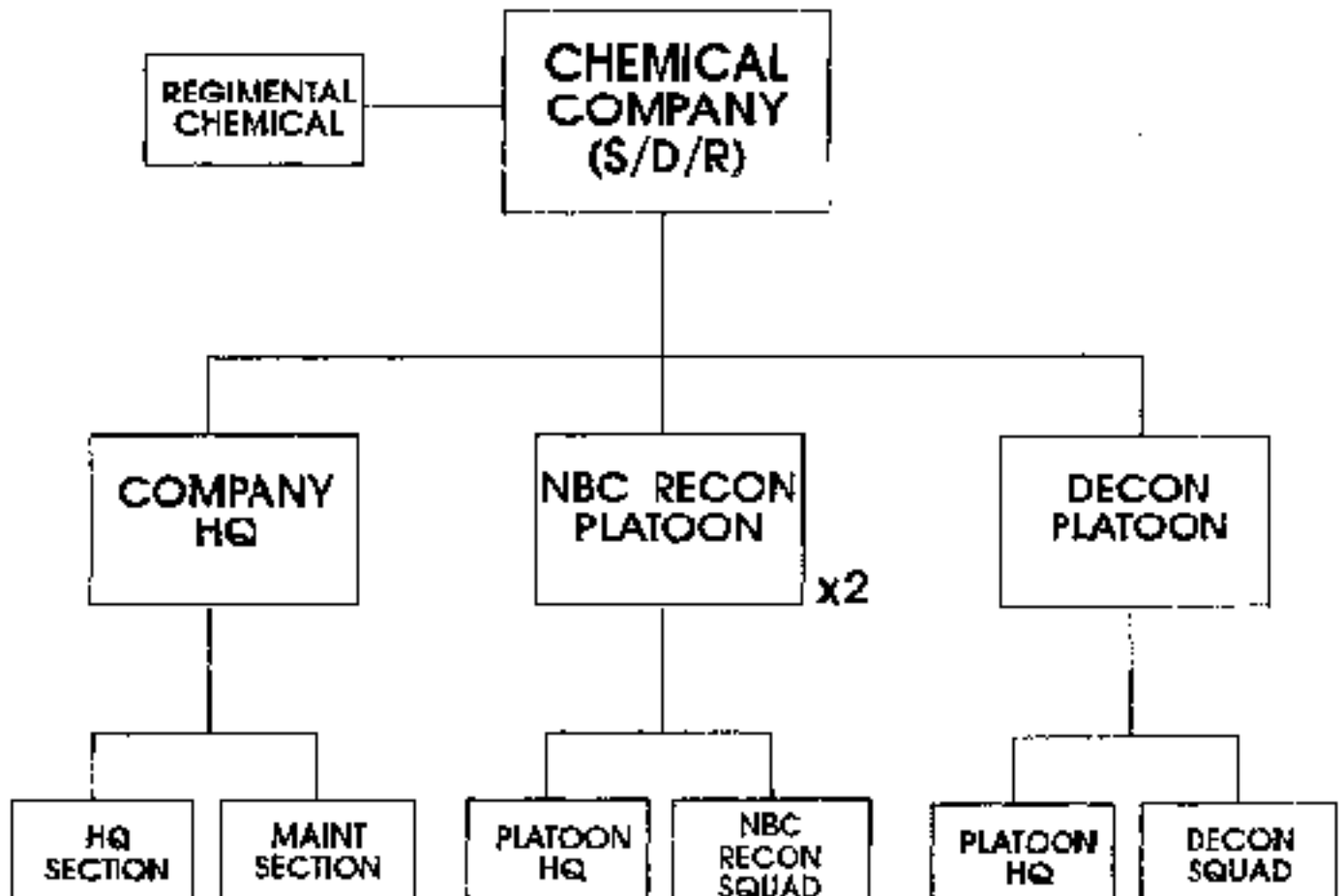

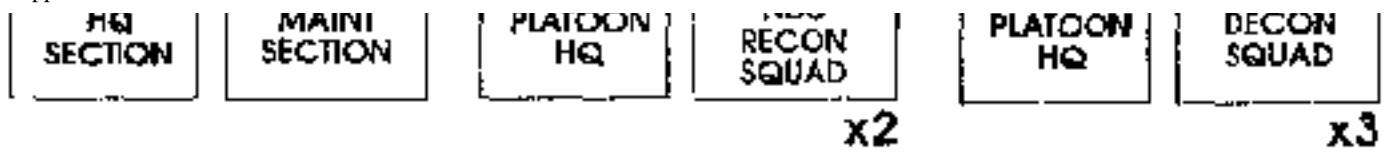

TOE: 03333L000

MISSION: To provide equipment decontamination, NBC reconnaissance, NBC warning and reporting, and chemical staff support for an light armored cavalry regiment.

PERSONNEL: 7 officers, 0 warrant officer, 65 enlisted

MAJOR EQUIPMENT SYSTEMS:

- 5 Trucks, cargo, 5-ton
- 3 Trucks, cargo, 2 1/2-ton
- 5 HMMWVs, 5/4-ton
- 1 Recovery vehicle, tracked
- 3 Tank and pump units
- 6 65gpm water pumps
- 8 M93 NBCRSs
- 6 M17 PDDEs
- 1 Generator set, 5kw
- 1 Generator set, 3kw

**HEAVY SEPARATE BRIGADE (ARMORED/MECHANIZED)  
and  
SEPARATE INFANTRY BRIGADE  
CHEMICAL PLATOON**

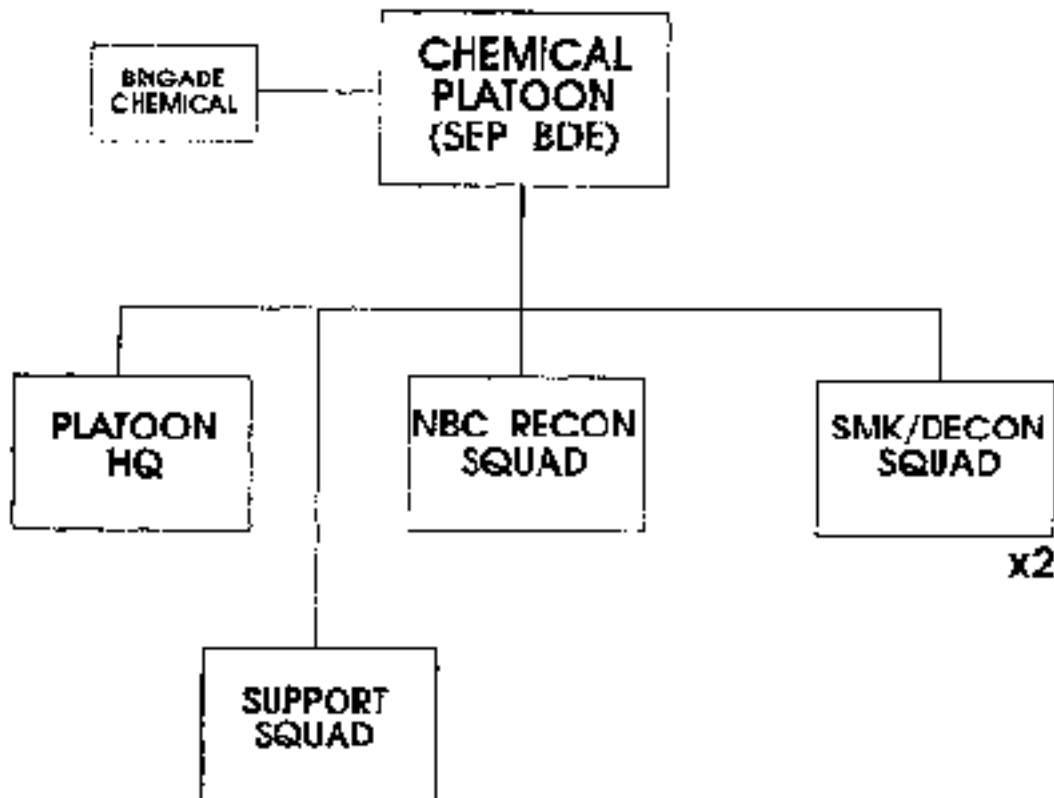

**MISSION:** To provide NBC staff services and smoke/decon support, radiation monitoring, chemical detection, and NBC reconnaissance support to brigade and attached units.

**PERSONNEL:** 4 officers, 0 warrant officer, 33 enlisted

**MAJOR EQUIPMENT SYSTEMS**

- 7 HMMWVs (1uvy)
- 2 HMMWVs
- 2 radio sets, AN/VRC-89
- 2 radio sets, AN/VRC-90
- 4 decon apparatuses, lightweight
- 6 generator sets, smoke, M157
- 6 trailers, 3/4-ton
- 5 trailers, cargo, LMTV
- 8 trailer, cargo, FMTV
- 7 alarms, chemical agent, XM22
- 1 water test kit, bacteriological
- 1 tank and pump unit
- 2 tank assembly, fabric, 3,000-gal

## FA TEAM (DECONTAMINATION)

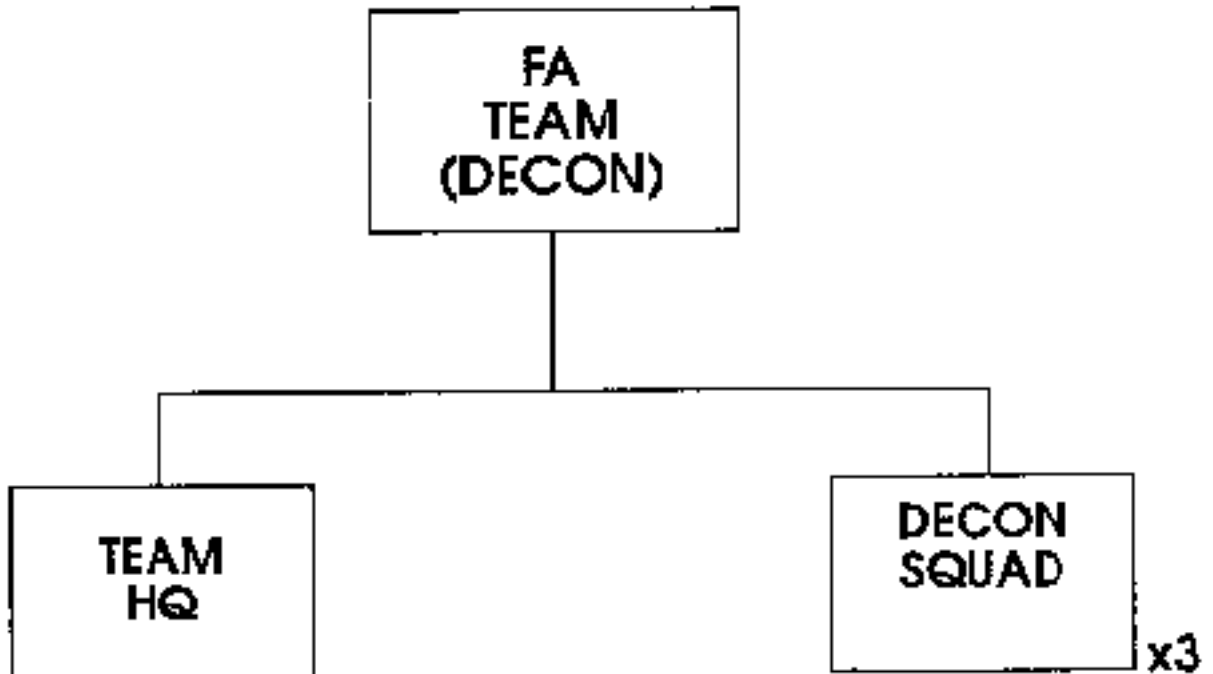

TOE: 0331 8LACC

MISSION: To provide equipment decontamination support.

PERSONNEL: 1 officers, 1 warrant officer, 22 enlisted

### MAJOR EQUIPMENT SYSTEMS

- 6 Trucks, cargo, 5-ton
- 3 Trucks, cargo, 2 1/2-ton
- 1 CUCVs, 5/4-ton
- 1 Trailer, 14-ton
- 9 Trailers, 1 1/2-ton
- 3 Tank, fabric, water, 3,000-gal
- 3 Tank and pump units
- 1 Radio set, AN/VRC-49 (AN/VRC-92)
- 3 Radio sets, AN/GRC-160 (AN/VRC-88)
- 9 65gpm water pumps
- 3 M2A1 PDDAs
- 3 Chemical alarms, M8AI
- 3 Machineguns, 7.62mm, M60



## JA TEAM (NBCE)



TOE: 03579LA00

MISSION: To provide NBC warning and reporting support.

PERSONNEL: 1 officers, 0 warrant officer, 4 enlisted

MAJOR EQUIPMENT SYSTEMS

1 HMMWV

1 Trailer, 3/4-ton

## JB TEAM (NBCE)

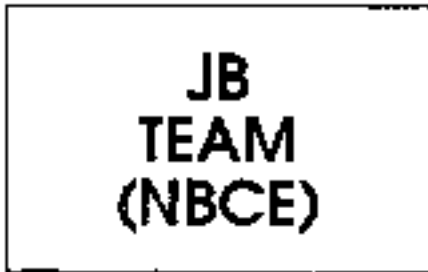

TOE: 03579LB00

MISSION: To provide NBC warning and reporting support.

PERSONNEL: 2 officers, 0 warrant officer, 8 enlisted

### MAJOR EQUIPMENT SYSTEMS

1 CUCV, 3/4-ton

1 Trailer, 3/4-ton

## LA TEAM (RECONNAISSANCE)



TOE: 035229LA00

MISSION: To provide NBC reconnaissance support.

PERSONNEL: 1 officers, 0 warrant officer, 5 enlisted

### MAJOR EQUIPMENT SYSTEMS

- 2 HMMWVs
- 2 Trailers, 1/4-ton
- 2 Radio sets, AN/VRC-46 (AN/VRC-90)
- 2 Machineguns, 7.62mm, M60

## LB TEAM (RECONNAISSANCE) (SPECIAL FORCES)

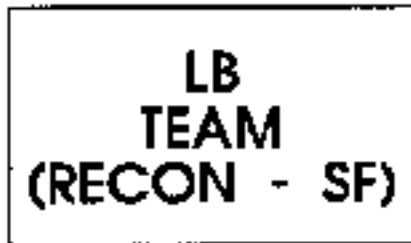

TOE: 03529LB00

MISSION: To provide NBC reconnaissance support.

PERSONNEL: 1 officers, 0 warrant officer, 4 enlisted

### MAJOR EQUIPMENT SYSTEMS

1 Radio set, AN/PRC-70

1 Radio set, AN/PRC-90

1 Camera set, KS-99

## SECTION III

# CHEMICAL UNIT EQUIPMENT CAPABILITIES

This section describes the major items of equipment found in the various chemical units.

### M12A1 PDDA

The M12A1 multipurpose, skid-mounted, power-driven decontamination apparatus ([Figure A-III-1](#)) consists of three major assemblies: pump unit, water tank and personnel shower assemblies, and an M2 water heater.

The pump unit assembly's prime-detergent tank holds priming water, detergent, or foaming liquids. The pump delivers up to 50 gallons of water or STB decontaminating agent slurry per minute at a working pressure of about 105 pounds per square inch using both hoses.

The skid-mounted, 500-gallon, stainless-steel tank has a working capacity of 447 gallons of water or 317 gallons of slurry. The hopper-blender assembly and fluid agitation system in the tank are used to blend STB agent and water. The shower assembly is used to form a field shower for showering up to 24 persons at a time. The M2 water heater is used with the pump and tank units to provide hot water for both decon and showering.

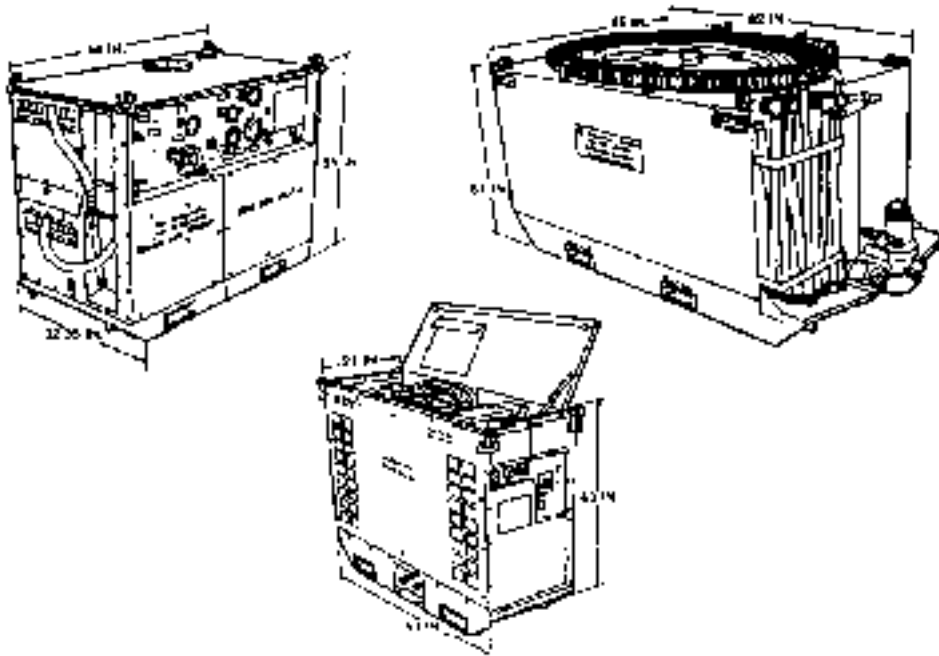

Figure A-III-1. M12A1 PDDA.

The M12A1 mixes and sprays decontaminating slurries and solutions and hot, soapy water rinses during decon operations. It is also used for fire fighting with water or foam, for de-icing operations, washing vehicles, pumping various fluids, and showering personnel in the field. The M12A1 cannot apply defoliants, herbicides, or insecticides.

The working pressure of the M12A1 is 60 to 120 pounds per square inch. The discharge rate for slurry or water with one spray gun is 25 gallons per minute; with two spray guns it is 50 gallons per minute. Water can be heated to 100 degrees Fahrenheit at a rate of 600 gallons per hour.

## M17 LDS

The M17 lightweight decon system, [Figure A-III-2](#), consists of a pumper/heating unit, an accessory kit, and a water storage tank. The basic unit is a portable lightweight, compact gasoline-powered 2-stroke

engine, with a belt-driven water pump and coil-type water heating unit. This equipment is designed to draw water from 30 feet away and 9 feet below pump level and deliver it at controlled temperatures up to 120 degrees Celsius and pressure up to 100 pounds per square inch. The 145-pound accessory kit contains hoses, cleaning jets, and shower hardware. The rubberized fabric self-supporting tank weighs 70 pounds empty and has a fill capability of 1,580 gallons. The entire unit is independent of outside power and provides a showering capability for up to 12 persons at a time.

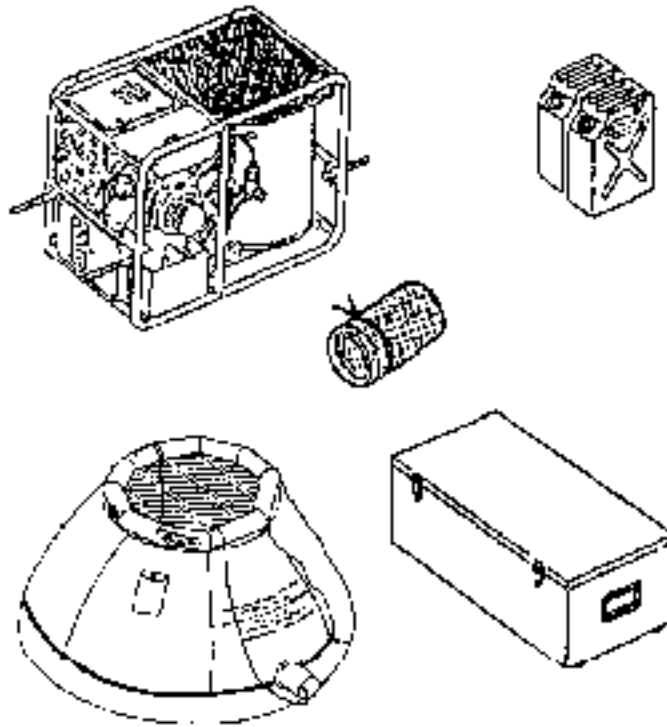

Figure A-III-2. M17 LDS.

## M1059

The M1059 mechanized smoke carrier, [Figure A-III-3](#), consists of an M113A2 armored personnel carrier with an M157 smoke generator set. The M157 is mounted on the carrier and cannot be dismounted. The M157 smoke generator set consists of two M54 smoke generator assemblies, a fog oil tank, air compressor assembly, fog oil pump assembly, and a control panel assembly. The M54 smoke generator assembly is a gasoline-operated pulse jet engine that vaporizes fog oil. The fog oil tank, mounted inside the carrier, holds up to 120 gallons of fog oil. The tank also acts as the mount for the fog oil pump assembly. This assembly contains two in-line fog oil pumps. The fog oil is drawn from the fog oil tank and flows to the smoke generators. The air compressor assembly uses a pressure tank to store the compressed air needed for starting and purging the pulse jet engine. The control panel assembly contains the necessary switches, control, and indicators for operating and monitoring each smoke generator, fog oil pump, and the air compressor.

The M1059 has a crew of three; vehicle commander, driver, and smoke generator operator. The vehicle commander also acts as the gunner for the M2 machinegun.

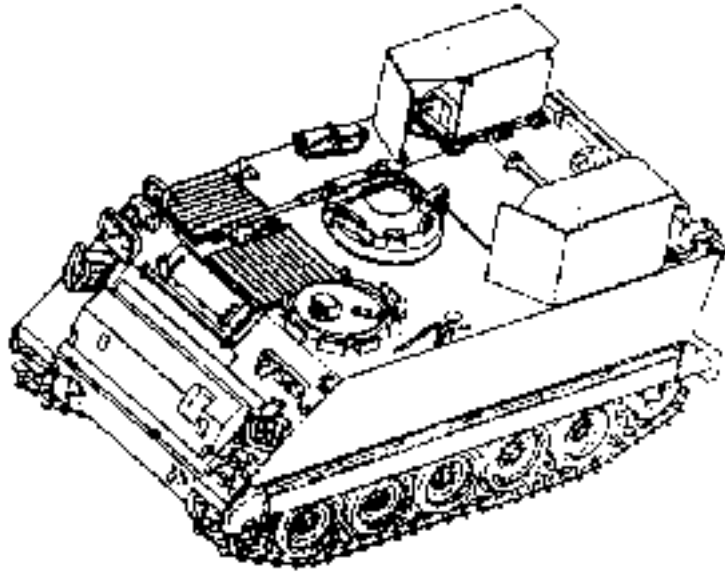

Figure A-III-3. M1 059.

## MOTORIZED SMOKE SYSTEM

The motorized smoke system, [Figure A-III-4](#), consists of the same components as the M1059 mechanized smoke carrier, except the components are mounted on a M998/M1037/M1097 HMMWV chassis. The system has a typical crew of two and is normally equipped with a M60 machinegun. The M157 smoke generator system cannot be dismantled.

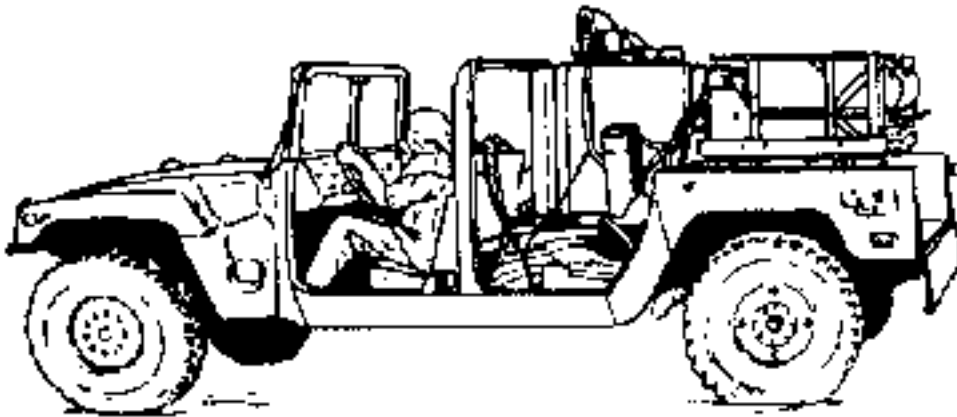

Figure A-III-4. Motorized smoke system.

## M3A4 SG

The M3A4 pulse jet mechanical smoke generator, [Figure A-III-5](#), is designed to generate large-area

smoke screens using fog oil. The M3A4 operates on the same principle as the M54 smoke generator, except that the M3A4 can be dismantled. The M3A4 consists of two assemblies: fuel tank and engine. The fuel tank supplies gasoline by gravity feed to the engine. The engine is started by a manually operated air pump. The M3A4 can be carried by two soldiers. Fog oil is drawn from its own container by a fog oil pump mounted on the engine assembly.

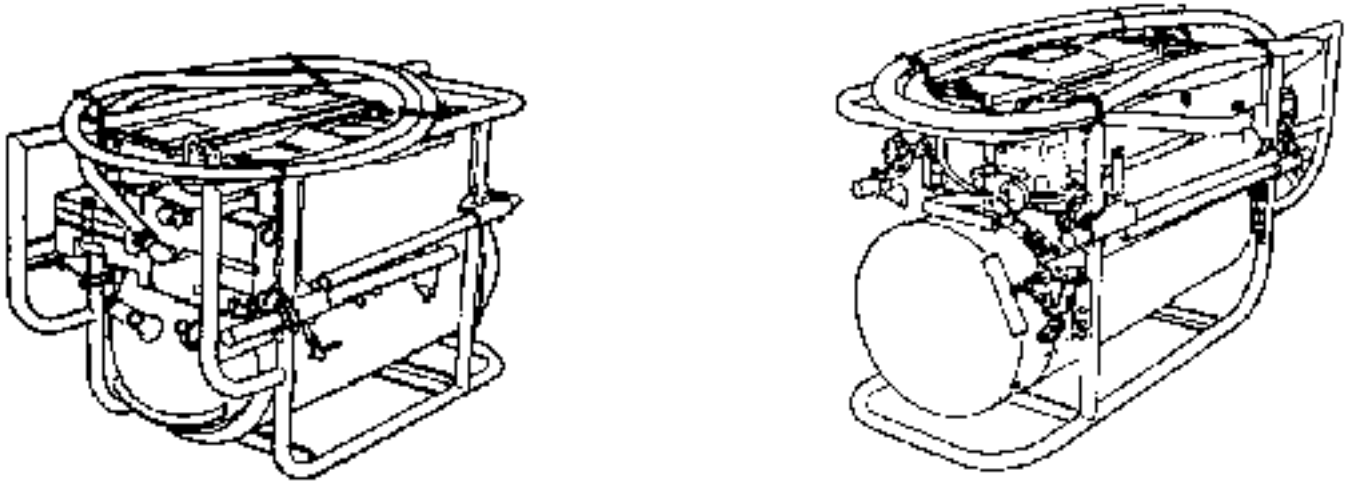

Figure A-III-5. M3A4 smoke generator.

### **M93 NBCRS (Fox)**

The M93 NBC reconnaissance system (NBCRS) (Fox) ([Figures A-III-6](#) and [A-III-7](#)), can locate, mark, and report NBC agent contamination on the battlefield. The crew can operate in a contaminated environment in an environmentally controlled suite inside the vehicle.

The M93 NBCRS is equipped with various chemical and nuclear detection devices. The MM1 mobile mass spectrometer is capable of identifying approximately 960 chemical compounds, but is programmed to monitor for 22 agents at any one time. All known chemical warfare agents are programmed in the MM1 for rapid identification. A pair of sampling wheels alternate contact with the ground, absorbing liquid contamination. The wheels alternate contact with the extended probe of the MM1. The heated probe draws vapor from the respective wheel and surrounding air for the MM1 to analyze.



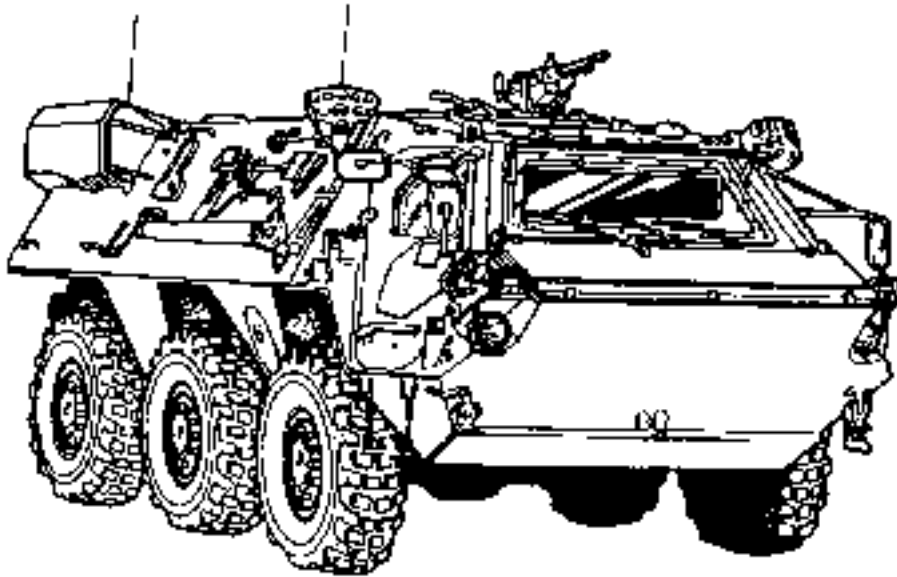

Figure A-III-6. M93 Fox (front view).

The crew can obtain samples of soil, vegetation, or munitions fragments without dismounting the vehicle or exposing themselves to contamination. The samples are stored in a sampling tray at the rear of the vehicle. The vehicle is also equipped with an M8A1 automatic chemical agent alarm and CAM as back-up detection devices.

For radiological contamination, the M93 NBCRS is equipped with the ASG1 and AN/VDR2 radiaic meters. These devices can measure radiation from .02 to 1,000 cGyph.

The vehicle is also equipped with the vehicle orientation system (VOS1). The VOS1 maintains a grid map location of the vehicle, allowing for accurate NBC surveys.



Figure A-III-7. M93 Fox (rear view).

The vehicle is crewed by four soldiers: vehicle commander, driver, MM1 operator (operator #1), and probe and sample arm operator (operator 2). The vehicle weighs 19.2 tons combat loaded. The vehicle is armed with an M240E1 7.62mm machinegun and two M250 smoke grenade launchers. The M93 NBCRS can enter the water and swim without stopping for external preparation. A pair of propellers at the rear of the vehicle steer and move the vehicle in the water. Vehicle speed in the water is a constant 6.5 mph; however, the vehicle wheels enable it to swim at 2.5 mph without use of the propellers.

[RDL](#)[Table of](#)[Document](#)[Download](#)[Homepage](#) [Contents](#) [Information](#) [Instructions](#)

---

## APPENDIX B

# CHEMICAL BRIGADE/BATTALION STAFF OPERATIONS

This appendix discusses the staff operations of chemical brigades and battalions. Brigade and battalion staff members need to be familiar with [FM 101-5](#) and [FM 101-5-1](#).

## RESPONSIBILITIES

### COMMAND GROUP

#### Brigade/Battalion Commander

Commands all subordinate chemical units. Provides subordinates with missions, taskings, and a clear statement of his concept for support. Allows his subordinates freedom of action in implementing his orders. Provides planning guidance for future operations. Positions himself to follow and influence operations and maintains communications with higher, lower, and adjacent units. Reacts immediately to direction from his higher commander to release and receive forces.

#### Deputy Brigade Commander

Assists the brigade commander. Keeps informed of operations, plans, intentions, and problems so he can assume command at anytime. Normally operates within specific areas defined by the commander. These may include responsibility for logistic support of the operation and execution of rear area operations.

#### Executive Officer (XO)

Principal assistant to the battalion commander. The battalion "chief of staff" is second in command. Principal coordinator of CSS in support of the subordinate units. During the commander's absence, he represents the commander and directs operations in accordance with established policies and guidance.

During operations, he is normally in the battalion TOC to monitor subordinate units, reports to higher headquarters, and the NBC situation throughout the command. Moves to any point in the area of operations to accomplish his duties and responsibilities.

### **Command Sergeant Major (CSM)**

Advises the commander on matters concerning the soldiers of the unit. Understands the administrative, logistics, and operational requirements of the unit. As the most experienced enlisted soldier in the brigade or battalion, he keeps track of the command. Receives taskings from the commander and acts as a troubleshooter. Focuses attention on functions critical to the success of the operation.

## **COORDINATING STAFF**

### **S1 (Adjutant)**

A principal staff officer with responsibility for exercising staff functions and coordination for personnel service support. Personnel service support encompasses the areas of personnel service, administrative services, health service support, finance support, postal services, chaplain activities, legal service support, morale, welfare support activities, and public affairs.

### **S2 (Intelligence Officer)**

A principal staff officer with responsibility for advising the commander on military intelligence and counterintelligence. Advises the commander and subordinate units on enemy situation and capabilities, weather and terrain. Coordinates with and provides information to the G2 element at the next higher headquarters.

### **S3 (Operations and Training Officer)**

The S3 is the principal staff officer in matters pertaining to the organization, training, and execution of primary mission operations. Assists other staff officers and is responsible for planning and executing brigade operations.

### **S2/S3 (Intelligence and Operations Officer)**

At the battalion level a single officer performs the functions of both the S2 and S3.

### **S4 (Logistics Officer)**

The S4 is the principal staff officer for logistical matters in the unit. Responsible for all maintenance, transportation and logistical services to the unit. Assists the commander in coordinating and providing CSS. Determines CSS requirements and priorities. Interfaces with the G4 section at the next higher headquarters.

## **SPECIAL STAFF**

### **Brigade/Battalion Signal Officer (BBSO)**

The staff officer responsible for communications activities within the brigade. Coordinates communications requirements and supervises communications personnel.

### **Headquarters and Headquarters Company/Detachment Commander**

The HHC/HHD commander ensures the command facilities have logistical support. Supervises the support, security, and movement of the TOC. Provides administrative, food service and logistical support to the brigade or battalion headquarters.

### **Chaplain**

The chaplain serves as both a personal and special staff officer. As a personal staff officer, the chaplain advises the commander on the unit's religious welfare, moral climate, and morale as affected by

religion. In addition, he advises the commander on the impact of local religions in the area of operations. As a special staff officer, the chaplain coordinates with the S1 to provide comprehensive religious support to soldiers and their families. This support includes providing or coordinating for worship services, sacramental rites, ordinance, pastoral care and counseling, memorial ceremonies or services, and ministry to battle-fatigued soldiers. Together, the chaplain and his enlisted chaplain assistant constitute a Unit Ministry Team (UMT).

## **Staff Judge Advocate**

Advises the brigade commander and staff on all legal matters including DOD directives, Army regulations, command policies, domestic, foreign and international law, status of forces agreements, and the UCMJ.

## **Aide-de-Camp**

Assists the brigade commander in apportioning his time and coordinating personal activities and command responsibilities. Provides for personal and security needs of the commander. Supervises other personnel provided for the commander's personal use (for example, chauffeur and executive administrative assistant).

## **LIAISON**

Liaison officers and NCOs (LNOs) represent the commander at other headquarters. Through personal contact they promote cooperation, coordination, and the exchange of essential information. It may be necessary to dispatch several liaison personnel to different headquarters during an operation.

Prior to departing to effect coordination, the LNOs will be thoroughly briefed by the TOC shift leader. They need to understand the concept of the operation, the status of all subordinate units, and subordinate unit locations. They also will be briefed on what information is needed and who they should coordinate with. The LNOs must have a vehicle with a radio.

Upon arriving at the headquarters to effect coordination, the LNO will report to the chief of staff or executive officer. They should keep an

accurate record of their coordination. If necessary, they should communicate up dated critical information to their headquarters. They also should check with the chemical staff section.

After completing their mission, they must report promptly back to their headquarters and brief the commander or his representative. The LNO should brief each staff section on the detailed information received. They keep abreast of the situation and are prepared to respond to future liaison requirements.

## **STAFF FUNCTIONS**

### **S1 SECTION**

Responsible for all matters pertaining to maintenance of unit strength, personnel management, manpower maintenance, morale, health services, and discipline of the command. Supervises the correspondence and mail activities of the unit. Operates the message center. Records the proceedings of boards and court-martials.

### **S2 SECTION**

Assists the commander and brigade staff on all matters pertaining to combat and NBC intelligence.

### **S3 SECTION**

Responsible for planning and directing all activities of the brigade relating to security, defense, training, plans and operations. This section publishes all OPLAN/OPORDs.

### **S4 SECTION**

Directs activities relating to the receipt, storage and issue of supplies; food services; and maintenance. Inspects and/or surveys operations and records of subordinate units. Advises on regulatory requirements; prepares instructions and technical guidance for subordinate elements.

## **COMMAND POST OPERATIONS**

## **FUNCTIONS**

The TOC facilitates tactical control and plans operations. The TOC stays abreast of the situation and ease the flow of information. Communications is maintained with lower, higher, and adjacent units. It answers command net calls so the commander need only monitor radio traffic. It posts maps, maintains records, monitors the status of subordinate units, and sends reports to higher headquarters as required. The TOC assists the higher and supported units with terrain management by coordinating the use of terrain by subordinate units.

The TOC receives, processes, and analyzes information; maintains historical journals; and updates the S3, XO, deputy commander, and commanders. The TOC also maintains liaison to the supported unit's chemical staff section.

## **LOCATION REQUIREMENTS**

The TOC location is selected by the S3 with the communications section NCOIC. The HHC/HHD commander selects the exact position.

### **Communications**

The TOC must be able to communicate with subordinate and supported units and higher headquarters on all required nets. The availability of MSE wire nodes will generally dictate the location of the TOC on the battlefield.

### **Access**

The TOC should be near, but not next to a road. The physical presence of the TOC should not interfere with the tactical maneuver of friendly units. When possible, a helicopter LZ should be nearby.

## **TOC OPERATIONS**

The TOC is organized and trained to conduct continuous operations. Shifts are established to operate the TOC and have the required expertise to make decisions on major issues. [Tables B-1](#) and [B-2](#) show a



recommended shift schedule for brigade and battalion TOCs. Off-duty shift personnel from the TOC can be used for security duties along with other personnel from the HHD.

Table B-1. Chemical Brigade Recommended TOC Shifts.

SHIFT A				
Position	Location	Section	Grade	MOS
S3*	S2/S3	CMD	LTC	74B54
S2*	S2/S3	CMD	MAJ	35D00
Threat Officer	S2/S3	S2	CPT	74B00
Clerk	S2/S3	S2	SPC	71L00
Operations Off	S2/S3	S3	MAJ	74A00
Operations Sgt	S2/S3	S3	SGM	54B50
NBC Staff NCO	S2/S3	S3	SFC	54B40
Illustrator	S2/S3	S3	SPC	81E10
S1*	S1/S4	CMD	MAJ	41A00
S4*	S1/S4	CMD	MAJ	92B00
PSNCO	S1/S4	S1	SFC	76B10
Legal NCO	S1/S4	S1	SFC	71D40
Food Service Tech.*	S1/S4	S4	WO2	822A0
Chief Supply Sgt	S1/S4	S4	MSG	76Z50
Clerk	S1/S4	S4	SPC	71L10
SHIFT B				
S3*	S2/S3	CMD	LTC	74B54
S2*	S2/S3	CMD	MAJ	35D00
Intelligence Off	S2/S3	S2	CPT	74B00
Intelligence Sgt	S2/S3	S2	SSG	96B00
Chemical Officer	S2/S3	S3	CPT	74B00
Operations Sgt	S2/S3	S3	MSG	54B50
Clerk	S2/S3	S3	SPC	71L00
S1*	S1/S4	CMD	MAJ	41A00
S4*	S1/S4	CMD	MAJ	92B00
Admin Spec	S1/S4	S1	SGT	75B20
Clerk	S1/S4	S1	SPC	71L00
Maint Officer	S1/S4	S4	CPT	82B00
Supply Spec	S1/S4	S4	SPC	76Y10
Material Officer	S1/S4	S4	CPT	82B00

Supply Spec	S1/S4	S4	SPC	76Y10
Material Officer	S1/S4	S4	CPT	92B00

\* works on either shift as necessary

Table B-2. Chemical Battalion Recommended TOC Shifts.

SHIFT A				
Position	Location	Section	Grade	MOS
Commander*	S2/S3	CMD	LTC	74A00
XO*	S2/S3	CMD	MAJ	74A00
S2/S3*	S2/S3	S2	MAJ	74B00
Operations Off	S2/S3	S3	CPT	74B00
Operations Sgt	S2/S3	S3	MSG	54B50
Clerk/typist*	S2/S3	S3	SPC	71L10
Chaplin*	S2/S3	CMD	CPT	56A00
S1	S1/S4	CMD	CPT	74B00
PSNCO	S1/S4	S1	SFC	76Z40
Property Book Tech	S1/S4	S4	WO	920A0
Sr Maint Supv	S1/S4	S4	MSG	63B50
Clerk	S1/S4	S4	PFC	71L40
Supply Spec	S1/S4	S4	SPC	75Y10
SHIFT B				
Commander*	S2/S3	CMD	LTC	74A00
XO*	S2/S3	CMD	MAJ	74A00
S2/S3*	S2/S3	S2	MAJ	74B00
Asst Opns Off	S2/S3	S3	LT	74B00
NBC NCO	S2/S3	S3	SSG	54B30
Clerk/typist*	S2/S3	S3	SPC	71L10
Chaplin*	S2/S3	CMD	CPT	56A00
S4	S1/S4	CMD	CPT	74C00
Legal & CO	S1/S4	S1	SGT	71D10
Property Book NCO	S1/S4	S4	SGT	76Y20
Supply Spec	S1/S4	S4	SPC	76Y20
Clerk	S1/S4	S4	SPC	71L40

\* works on either shift as necessary

\* works on either shift as necessary

## THE PLANNING PROCESS

The brigade and battalion staffs use the military decisionmaking process outlined in Annex D to develop their support plans. The chemical brigade and battalion staffs normally conduct parallel planning. Parallel or concurrent planning is planning conducted simultaneously at all command and staff levels. For example, while the corps staff is planning the next operation, the chemical brigade staff is concurrently planning to support that operation. This requires significant interface between the headquarters. The use of liaison personnel and the supported unit chemical staffs is essential.

Warning orders allows subordinate units to begin preparing for the next operation. Critical time is wasted if warning orders are not issued as soon as possible. There is no format for warning orders; however, they should contain five minimum essential elements (shown in [Figure B-1](#)).

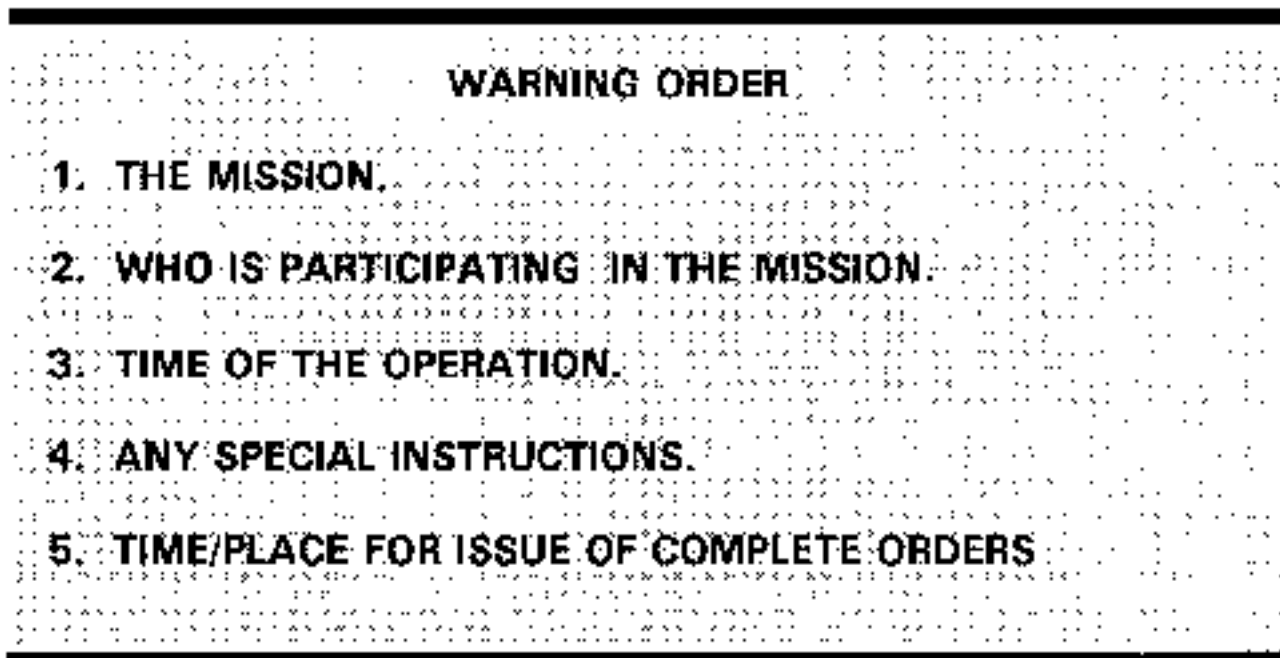

Figure B-1.

Time is a critical resource that must be managed by all staffs. A time plan for each operation is developed to ensure subordinate units get enough time to plan, rehearse and prepare their orders. The backward planning process, where time is planned from the point of plan

execution back to the present should be used.

The amount of time available for planning will dictate the level of detail in the operations order (OPORD) and how the order is issued (oral or written). OPORDs are as detailed as time allows. Matrix type orders can substitute for detailed written orders when there is a limited amount of planning time involved. Formats for orders are in [Appendix F](#)

## CONTINUOUS OPERATIONS

Headquarters operate on a continuous basis during combat operations. It is impossible to staff the headquarters with sufficient personnel to operate 24 hours without any degradation in operations. Performance and efficiency begin to deteriorate after 14 to 18 hours of continuous work and reaches a low point after 22 to 24 hours. Operations under NBC conditions quicken this deterioration. Soldiers cease to be effective after 72 hours without sleep.

Commanders and leaders must recognize the signs of sleep loss to minimize its effects. These are--

- Slower reaction time.
- Increased time to perform a known task.
- Short-term memory decrement.
- Impairment in learning speed.
- Errors in omission.
- Lapses of attention.
- Irritability.
- Depression.
- Erratic performance.

A strictly enforced sleep plan is used when possible. Each soldier

should get a minimum of four hours rest each 24-hour period. Leaders also must realize that soldiers require time to recover from sleep loss. After an operation of 36 to 48 hours without sleep, a soldier needs about 12 hours of sleep or rest to return to normal functioning. After more than 72 hours without sleep, an individual may require as much as two or three days of rest to recover.

[RDL](#)[Table of](#)[Document](#)[Download](#)[Homepage](#) [Contents](#) [Information](#) [Instructions](#)

---

## APPENDIX C

# NBC STAFF RESPONSIBILITIES AND DUTIES

Chemical staff officers and NCOs have many responsibilities and duties. At corps and division levels the duties and responsibilities are very similar. From brigade down to company level, chemical responsibilities and duties are also very closely aligned. The brigade and battalion chemical staff sections frequently work together to monitor, improve, and sustain NBC training, unit equipment readiness, and SOPS at unit level.

The various chemical staff sections must know their supporting chemical unit's organization and functions. This requires chemical staffs to coordinate and plan with chemical units designated in the various operational and contingency plans to support them. Both chemical staffs and units should establish habitual relationships.

## CORPS CHEMICAL STAFF

### CORPS CHEMICAL OFFICER

Advises the corps commander and staff on all matters pertaining to NBC defense and the concept for chemical unit support of corps operations. Has overall supervisory responsibility for the chemical staff (corps chemical section and NBC element). Relies on subordinate chemical staff personnel to collect, collate, evaluate, and distribute NBC data. Recommends NBC defensive posture and operations. Supervises and monitors NBC training throughout the command. Provides technical supervision of all NBC activities.

This officer, jointly with the corps surgeon, verifies enemy first use of biological/chemical weapons. The verification is passed to the National Command Authority (NCA) by the most expeditious means.

Assists the chemical brigade commander in making recommendations to the corps commander and the G3 on organizing and employing corps chemical units.

Evaluates the nature and extent of contaminated terrain and units. Formulates plans for NBC recon, decon, and/or smoke support. Conducts liaison with a host nation for NBC decon, recon, and smoke support.

## **ASSISTANT CORPS CHEMICAL OFFICER**

Act for the corps chemical officer in his absence. Stays abreast of all NBC situations and matters. Assists the corps staff in planning defensive operations and formulating the NBC portion of plans and orders. Prepares NBC estimates and SOPs for defense against NBC attacks. Gives planning guidance to the two chemical staff officers supervising the corps chemical section and NBC element activities. Specifically, he gives guidance on what NBC information needs to be obtained and where it is to be distributed. Normally is located in the NBCC of the corps main CP.

## **CHEMICAL STAFF OFFICER**

There are three chemical staff officers assigned to the corps chemical staff. Each officer works in a different CP or cell during field operations.

## **TAC CP Chemical Staff Officer**

Located at the corps tactical CP. Primary duty is to monitor current NBC operations and the execution of the current corps plan. Keeps the chemical staff at the corps main CP informed on NBC matters. Stays abreast of the corps commander's intent and advises him on the employment of chemical units. Specifically focuses on--

- The operational status and location of corps chemical units, including those task-organized to subordinate units.
- Current NBC situation.
- The location of contaminated units and terrain.

- Assisting in issuing warning orders and fragmentary orders to chemical units in support close operations.
- Synchronizing NBC defense and chemical units in support of close operations.
- Maintaining liaison with supporting chemical unit headquarters (brigade or battalion).

### **Plans Chemical Staff Officer**

Works in the main CP plans cell. Responsible for the integration of NBC defense and chemical of unit operations in all plans and orders. Prepares the NBC estimate and the NBC/chemical support annex to plans and orders. Receives guidance from the corps chemical officer, chemical brigade commander, and chemical brigade S3 on the employment of chemical units in support of future corps operations.

### **Intelligence Chemical Staff Officer**

Works in the main CP current operations cell. Responsible for coordination with the intelligence cell Conducts vulnerability analysis based on the latest intelligence. Provides input on priority information requirements and information requirements. Assists the plans chemical officer on developing the enemy situation for estimates, plans, and orders.

### **NBC STAFF OFFICER AND NBC ELEMENT DIRECTOR**

Both located at the corps main CP in the NBCC. Each functions as a 12-hour shift supervisor of the NBCC. They work closely with the G2 element to develop plans to gather intelligence, analyze enemy NBC capabilities, and determine if the enemy plans to use NBC weapons. They supervise the collection, collation, evaluation, and dissemination of NBC reports and data, These officers predict the effects of enemy NBC weapons on corps operations and supervise the maintenance of the NBC situation map. In addition, they assist in the planning and coordination for logistical support requirements of subordinates. Additionally they --

- Perform continuous NBC IPB for impacts on current and future



operations.

- Maintain NBC threat information.
- Provide current and anticipated enemy NBC situation information to the NBCC.
- Maintain the status of NBC equipment and CDE.
- Track NBC equipment and CDE consumption rates.
- Forecasts NBC equipment and CDE requirements.
- Assist in coordinating host nation NBC support.
- Assist in the coordination of reconstitution operations when chemical assets are required or involved.

### **SENIOR NBC STAFF NCO (SGM)**

The senior chemical NCO on the corps staff. Responsible for the training of all enlisted soldiers on the corps chemical staff and supporting JA Team. During field operations, he works in the main CP in the NBCC and functions as a 12-hour shift NCOIC. As the shift NCOIC, he assists the shift OIC. Supervises the processing of NBC attack information, coordinates with other staff sections, prepares and disseminates CDM/EDM messages, and manages the NBCWRS. Ensures that all staff journals, files, and records are maintained. Supervises maintenance of the section's vehicles. Advises the corps chemical officer on the distribution of chemical personnel within the corps and training and readiness issues.

### **NBC STAFF NCO (SFC)**

Assists the chemical staff officer in the TAC CP. He normally works the shift in the TAC CP opposite of the chemical staff officer. Duties are identical with the chemical staff officer's duties.

### **OPERATIONS SERGEANT**

NCOIC of the JA Team, acting as a 12-hour shift NCOIC in the NBCC.

Works opposite the senior NBC staff NCO. Supervises the processing of NBC attack information, coordinates with other staff sections, prepares and disseminates CDM/EDM messages, and manages the NBCWRS. Ensures that all staff journals, files, and records are maintained. Supervises maintenance of the section's vehicles.

## **COMPUTER-PLOTTER**

There are five computer-plotters and they work in various CPs and cells during field operations.

### **NBCC Computer-Plotter**

Four of the NCOs work at the NBCC in the main CP to receive, process, and plot NBC attack information. Determine downwind hazard predictions of enemy chemical and biological agent clouds and radioactive fallout. Prepare and disseminate the appropriate NBC reports. Maintain the visual displays and the staff journals as required. Maintain the NBC situation map in the NBCC. They gather NBC information from the subordinate command's situation reports. Operate the MCS terminal and use ANBACIS to maintain an NBC information database. They send and receive messages as needed. Transmit detailed instructions to radiological survey parties and survey operations. Calculate transmission or correlation factors as required from reports provided by radiological monitoring or survey parties. Prepare and disseminate EDMs and CDMs. Select correction factors for radiological decay from tables, graphs, or nomograms. Convert radiological contamination data to ground dose rates at a reference time. Maintain radiation status reports of subordinate corps units. Perform detailed vulnerability analysis.

### **Plans Computer-Plotter**

Assists the chemical staff officer in the plans cell at the main CP. Assists in the preparation of the NBC/chemical support plans.

### **Clerk-Typist**

Performs general administrative support functions for the NBCC in the main CP. Acts as the radio-telephone operator. Prepares and dispatches messages and maintains the daily staff journal/message

file. Receives and records NBC messages and helps to prepare NBC contamination overlays for transmission.

## **DIVISION CHEMICAL STAFF**

### **DIVISION CHEMICAL OFFICER**

A special staff officer who functions with the primary staff responsibility of the G-3. Advises the division commander on NBC defense measures, employment of chemical units, smoke, and flame. Exercises OPCON of the divisional chemical company. Supervises the division chemical staff. Coordinates and provides technical expertise to subordinate chemical staffs and units. The staff assists him in supervising and monitoring NBC training throughout the command and technical supervision of all NBC activities.

Coordinates with supporting chemical units. Recommends to the division commander and the G3 on how supporting chemical units should be task-organized, employed, and supported.

Evaluates the nature and extent of contaminated terrain and units. Formulates plans for NBC recon, decon, and/or smoke support. Conducts liaison with a host nation for NBC decon, recon, and smoke support.

### **TACTICAL CHEMICAL OPERATIONS OFFICER**

Acts for the division chemical staff officer in his absence. Tracks all NBC situations and matters. Assists the division staff in planning operations and formulating the NBC portion of plans and orders. Prepares NBC estimates and SOPs for defense against NBC attacks. Operates from the division TAC CP and monitors current NBC operations and the execution of the current division plan. Keeps the chemical staff at the division main CP informed on NBC matters. Stays abreast of the division's intent and advises on the employment of chemical units. Specifically focuses on--

- The operational status and location of supporting chemical units including those task organized to subordinate units.
- The current NBC situation.

- The location of contaminated units and terrain.
- Assisting in issuing warning orders and fragmentary orders to chemical units in support of close operations.
- The synchronization of NBC defense and chemical units in support of close operations.
- Maintaining liaison with support chemical unit headquarters.

## **CHEMICAL OFFICER AND NBC OFFICER**

Located at the division main CP, where each functions as a 12-hour shift supervisor of the NBCC. They work closely with the G2 element to develop plans to gather intelligence, analyze enemy NBC capabilities, and determine if the enemy plans to use NBC weapons. Supervise the collection, collation, evaluation, and dissemination of NBC reports and data. Predict the effects of enemy NBC weapons on division operations and supervise the maintenance of the NBC situation map. Plan and coordinate for logistical support requirements of subordinate chemical units.

## **NBC OPERATIONS NCO (SGM)**

The senior chemical NCO in the division. Trains all enlisted soldiers on the division chemical staff. Functions as a 12-hour shift NCOIC, assisting shift OIC. Supervises the processing of NBC attack information, coordinating with other staff sections, preparing and disseminating of CDM/EDM messages, and the managing of the NBCWRS. Ensures that all staff journals, files, and records are maintained. Supervises maintenance of the section's vehicles. Advises the division chemical officer on the distribution of chemical personnel within the division and training and readiness issues.

## **CHEMICAL OPERATIONS NCO (MSG)**

Acts as a 12-hour shift NCOIC of the division NBCC in the main CP, working opposite the NBC operations NCO. Supervises the processing of NBC attack information, coordinating with other staff sections, preparing and disseminating of CDM/EDM messages, and the managing the NBCWRS. Ensures that all staff journals, files, and records are

maintained. Supervises maintenance of the section's vehicles.

## **NBC STAFF NCO**

Assists the tactical chemical operations officer in the TAC CP. Duties are very similar to those of the tactical chemical operations officer.

The other works in the division NBCC. Assists in the processing of NBC attack information, coordinating with other staff sections, preparing and disseminating of CDM/EDM messages, and the managing the NBCWRS. Ensures that all staff journals, files, and records are maintained.

## **OPERATIONS NCO**

Works in the TAC CP with the NBC staff NCO on a 12-hour shift opposite of the NBC staff NCO. Duties are identical with those of the NBC staff NCO.

## **COMPUTER-PLOTTER AND NBC NCO**

They perform identical functions, but on opposite shifts. Receive, process, and plot NBC attack information and determine downwind hazard predictions of enemy chemical and biological agent clouds and radioactive fallout. Prepare the appropriate NBC reports and distribute them. Maintain the visual displays and the staff journals as required. Maintain the NBC situation map in the NBCC. They gather NBC information from the subordinate command's situation reports. Operate the MCS terminal and use ANBACIS to maintain an NBC information database. Send and receive messages as needed. Transmit detailed instructions to radiological survey parties and survey operations. Calculate transmission or correlation factors as required from data provided by radiological monitoring or survey parties. Prepare and disseminate EDMs and CDMs. Select correction factors for radiological decay from tables, graphs, or nomograms. Convert radiological contamination data to ground dose rates at a reference time. Maintain radiation status reports of subordinate division units.

## **CLERK-TYPIST**

Performs general administrative support functions for the NBCC. Acts as the radio-telephone operator. Prepare and dispatches messages and

maintains the daily staff journal/message file. Receives and records NBC messages. Prepares chemical and radiological contamination overlays for transmission.

## **BRIGADE CHEMICAL STAFF SECTION**

The brigade chemical staff section serves as a focal point for all NBC matters. Brigade chemical staff monitor the unit NBC readiness status of subordinate battalions. They also plan for and request chemical unit support.

Additionally assist with--

- Training and evaluation.
- Logistics.
- Chemical personnel management.
- Unit NBC equipment readiness.

This section consists of the brigade chemical officer and the brigade chemical staff NCO. The following paragraphs present their basic operational responsibilities and duties.

### **BRIGADE CHEMICAL OFFICER**

The brigade commander's chief advisor on all NBC matters. Makes recommendations on chemical unit employment. Assists in preplanning and coordinating logistical requirements for supporting chemical units. Provides NBC staff assistance to subordinate battalions.

Informs the brigade commander of threat NBC capabilities relevant to the brigade's area of operations. Ensures that PIR and threat information are reflected in unit operation plans and SOPs. Assists subordinate units in disseminating NBC threat information to key and newly assigned personnel.

Assists the battalion chemical staff officer in determining battalion-level training requirements. Formulates training recommendations through frequent staff visits, evaluations received from field

training missions, and SDT and ARTEP results. Ensures quotas are provided to subordinate battalions for post or area NBC defense schools.

Reviews subordinate unit NBC equipment status. Assists subordinate units to determine NBC equipment authorizations. Forecasts NBC equipment requirements to support future training and war reserve stockage.

Recommends to the division chemical staff and brigade S1 concerning the assignment of chemical personnel within the brigade. Assists the division chemical staff with monitoring utilization of chemical personnel within the brigade.

Writes and updates the NBC annex to the brigade SOP. Maintains and requisitions required NBC publications.

Assists the brigade S4 in identifying CDE and NBC equipment requirements. Ensures that adequate quantities of CDE and NBC equipment are identified and requisitioned to support NBC training. Assists the brigade S4 in planning the rotation of forward pre-positioning stocks of NBCDE, decontaminants, and fog oil.

Prepares and distributes NBC reports received from the battalions and division. Advises the commander on NBC defensive measures. Recommends to the brigade S3 and the commander the employment of supporting NBC recon, smoke, and decon units. Consolidates battalion radiation status reports (see [FM 3-3-1](#)) and transmits this information to the division chemical staff section.

Establishes and supervises the brigade NBC subcollection center. Coordinates NBC support activities with appropriate host nation territorial organizations.

The brigade chemical staff NCO works closely with the brigade chemical officer and with battalion NBC NCOs. Through periodic staff visits, this NCO closely evaluates NBC defense training, to include integration of NBC defense tasks during field training exercises. Ensures that all individuals and units can perform common individual and collective NBC tasks.

Inspects the rotation of shelf-life items and load plans for NBC war

reserve stocks. Conducts periodic inspections of unit NBC equipment to ensure authorized equipment is on hand and serviceable.

## **BATTALION CHEMICAL STAFF**

The battalion chemical staff consists of--

- An assistant S3/chemical officer (1LT or 2LT).
- An NBC staff NCO (SSG),

Their responsibilities and duties parallel those of the brigade chemical staff section. There are two main differences. First, a decon specialist is on the battalion chemical staff (except in the light infantry divisions). Second, the battalion chemical officer is the assistant S3.

## **COMPANY NBC NCO**

Works in company operations where he is immediately available to the company commander. Advises on NBC matters that affect company operations.

Provides assistance and guidance during company NBC training operations. The company NBC NCO recommends the NBC training program. Sources are SDT and ARTEP results and guidance from the battalion chemical staff NCO. Training areas include--

- Ensuring NBC common task training is being sustained by first line supervisors.
- Ensuring that leader NBC tasks are sustained.
- Integrating NBC collective tasks into unit training.
- Integrating NBC as a condition for the performance of METL tasks.

Reports NBC equipment status to the battalion chemical staff section. Periodically inspects and supervises the operations and team maintenance of NBC equipment. NBC equipment responsibilities include--



- Coordinating the requisition of NBC equipment (classes II and IV) and repair parts (class IX).
- Coordinating the turn-in of unserviceable NBC equipment with the supply NCO.
- Turning-in radiac instruments that need to be calibrated.
- Rotating NBC equipment that contains expiration dates.
- Performing protective mask organizational maintenance.
- Conducting training on the use and employment of MTOE NBC equipment.

Advises the commander on decon, smoke, combat flame, and NBC recon support requirements. Recommends the location for operational decon operations. Supervises and assists in the conduct of operational decon. During either operational or thorough decon operations, ensures contaminated personnel are briefed on the operation and their responsibilities.

Operates out of the company CP. Monitors reports of NBC attacks and advises the commander on their impact. Receives NBC3 and NBC5 reports from battalion and plots the information. Recommends and advises the commander on--

- Contamination avoidance.
- Protective posture.
- Decon operations.
- Decon (including NBC sampling, radiological survey, and chemical agent identification).
- Smoke and flame field expedients.

### **UNIT PDDE OPERATOR**

Operates and maintains the two light decon systems (LDSs) to support

battalion operational decon operations. Receives mission guidance from the battalion chemical officer or NCO. May be attached to a company. Receives assistance from the supported company's NBC NCO in planning and conducting a platoon-size operational decon missions. Also assists the battalion NBC staff NCO in inspecting NBC equipment and evaluating battalion NBC training and readiness.

[RDL](#)[Table of](#)[Document](#)[Download](#)[Homepage](#) [Contents](#) [Information](#) [Instructions](#)

---

## APPENDIX D

# THE MILITARY DECISIONMAKING PROCESS (MDMP)

The tactical planning process focuses on accomplishing the mission within the commander's intent. Chemical planners at all levels integrate their plans into other battlefield operating systems to maximize force effectiveness. This appendix discusses the chemical staff's actions in the planning process. For more detailed information on the planning process, see [FM 101-5](#).

Tactical planning is a continuous process. Commanders and staffs continuously assess new information for its impact on current and future operations. While planning is continuous and cannot be totally isolated from current actions, it is a sequential process that begins with the receipt of the higher headquarters' order.

Chemical officers at all levels must understand the planning process and their role in it. Staffs at all levels use the military decision making process (MDMP) ([Figure D-1](#)) to prepare operational plans or orders. The MDMP has ten major steps: receipt of the mission, information exchange, mission analysis, staff estimates, commander's decision, preparation of plans/orders, approval of plans/orders, issuance of plans/orders, supervision, and mission execution.

## RECEIVE MISSION

Planning begins with receipt of the order from the higher headquarters. The battle staff assembles and gathers the critical information needed by the commander to begin the planning process.

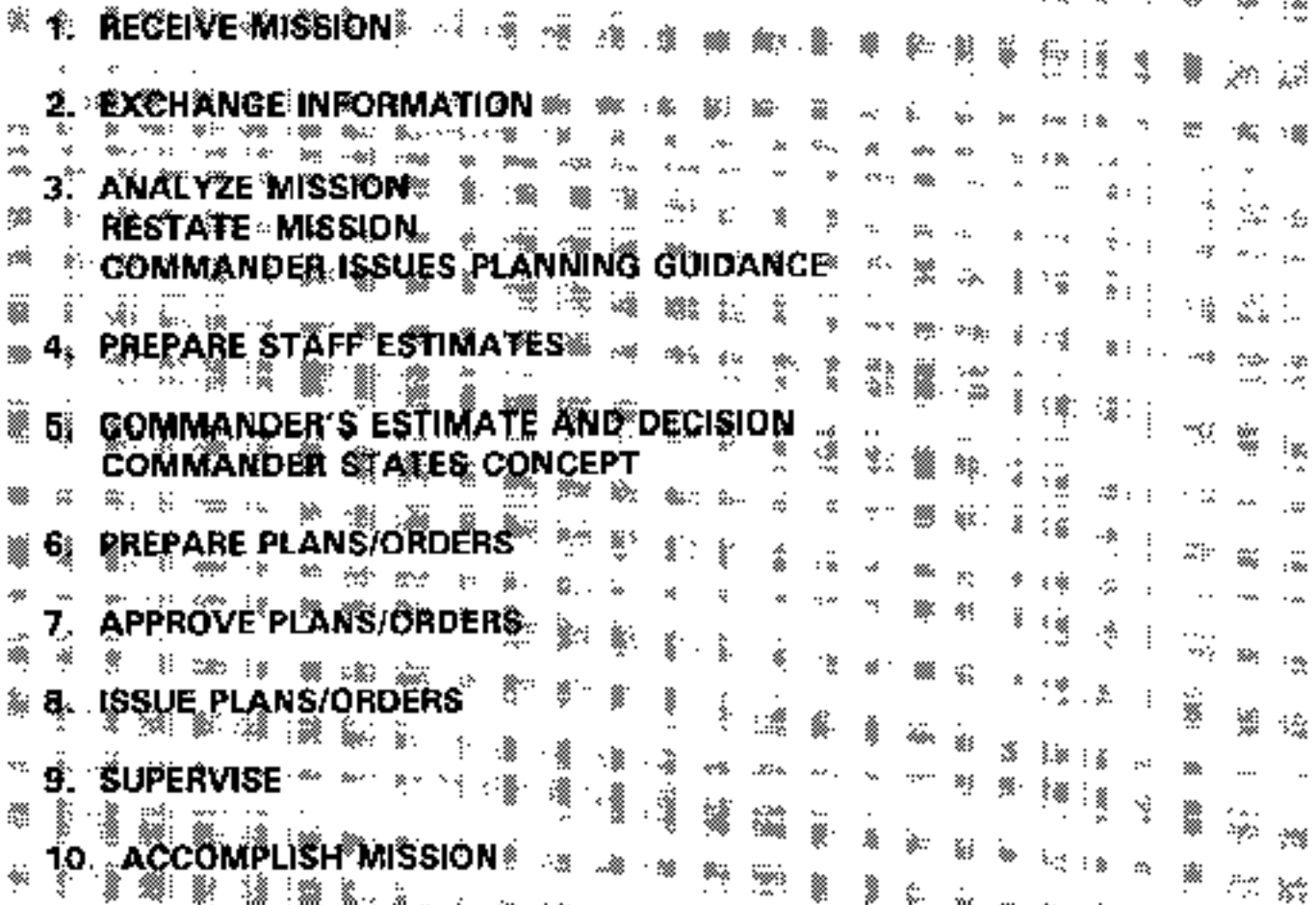

Figure D-1. The Military Decision Making Process

## EXCHANGE INFORMATION

During this phase of the MDMP, the commander and the staff exchange information concerning the unit's current status. This information may include the NBC threat, status of supporting chemical units, areas of contamination, contaminated units, current decontamination operations, and the current MOPP level. The information provided should require immediate attention or have a lasting affect on the next mission, for example, the next mission is a hasty attack (line of departure (LD) within 12 hours), the TF's only tank company is contaminated and the supporting decon platoon has not yet linked up. This requires immediate attention and will affect the development of the scheme of maneuver.

The chemical officer must be ready to present this information to the commander--

- Current NBC threat (to include probability of attack).

- Current MOPP level.
- Current status of supporting chemical units.
  - Location.
  - Current capability.
  - Anticipated capability.
- Status of any contaminated units or ongoing decontamination operations

### **ANALYZE MISSION**

During mission analysis, the higher headquarter's order is analyzed to determine what must be accomplished. The chemical officer is primarily concerned with identifying all specified, implied, and essential/critical tasks concerning NBC defense. Restraints and constraints are also identified. The identification of implied tasks includes an analysis of the enemy's NBC capability and employment doctrine. If the enemy uses persistent agents to block avenues of approach or to shape the battlefield, some implied tasks during an offensive mission might be to--

- Identify contaminated areas in zone.
- Mark contaminated areas.
- Cross contaminated areas.
- Conduct operational decontamination.
- Coordinate for thorough decontamination.
- Evacuate contaminated casualties.
- Recover contaminated vehicles/equipment.
- Move contaminated vehicles/personnel to a decon site.

- Establish appropriate MOPP level.
- Employ smoke.
- Assist in patient decon planning.
- Assist in mortuary affairs decon planning.

When tasks are identified, the cprocesschemical officer works with the G3/S3 to incorporate any essential/critical tasks into the unit's restated mission, if necessary. The G2/S2 presents the initial threat analysis to the commander as part of the mission analysis. A general NBC threat assessment should have been developed between the G2/S2 and the chemical officer prior to presentation of the initial threat analysis to the commander. The commander will then issue his planning guidance, usually by battlefield operating system and battlefield framework (deep, close, and rear), and his intent for the operation. The planning guidance may be general or specific in nature. The chemical officer uses the restated mission as the basis for his estimate.

## **PREPARE STAFF ESTIMATE**

The staff estimate is a four part process: situation analysis, course of action analysis, course of action comparison, and the recommendation to the commander. The level of detail is dependent on the amount of planning time available. However, the steps that the chemical officer goes through to develop his estimate are the same despite the time available. Coordination with other staff sections (fire support, operations, intelligence, air defense, engineers, and combat service support) is critical. Written estimates are rare! y found below corps or division level. However, the chemical staff officer should follow the format at [Figure D-2](#) to ensure all considerations are examined.

## **SITUATION ANALYSIS**

During situation analysis, the chemical staff officer first examines those aspects of the weather, terrain, enemy, and friendly forces that are significant from the standpoint of NBC defense. The analysis is an

interactive process for the entire staff, so the chemical officer cannot wait upon other members to complete their portions of the analysis before beginning to develop his own. The situation analysis drives the later development of the plan.

The area of operations is examined to determine the effects of weather and terrain on chemical and smoke employment. The chemical officer, with the G2/S2 determine the enemy's capability to use NBC weapons, smoke and flame. The chemical officer assesses what effect these could have on friendly forces. The friendly situation is examined to determine what chemical corps assets are available to support the mission and the NBC defense training status. Possible courses of action for chemical unit support are developed. Each course of action is analyzed to determine its advantages and disadvantages in relation to the situation and the possible NBC threat. They are compared and the most advantageous one is recommended to the commander or G3/S3.

The chemical officer continues his situation analysis by reviewing the friendly situation including forces and resources available for the mission (including those available at the higher headquarters). The chemical officer assesses the availability of personnel and logistics to support chemical operations, identifying any significant limitations. The chemical officer works with the G1/S1 and G4/S4 when determining the personnel and logistic requirements. The current status of contaminated units, their current operations, and when decontamination will be completed are also determined.

## THE NBC ESTIMATE

1. **Mission.** Restated mission.
2. **The situation and considerations.**
  - a. **Area of operations.**
    - (1) **Weather.**
      - (a) Existing conditions.
      - (b) Predicted conditions.
      - (c) Effect on enemy employment of NBC weapons.
    - (2) **Terrain.**
      - (a) Effect on enemy employment of NBC weapons.
      - (b) Enemy use of persistent agents to restrict/canalize friendly forces.
  - b. **Enemy situation.**
    - (1) NBC employment capability.
    - (2) Previous use of NBC weapons.
    - (3) Predicted employment.
  - c. **Own situation.**
    - (1) Current defensive posture.
    - (2) Chemical assets available.
    - (3) Contamination status (areas, units, and so forth).
3. **Analysis of courses of action.** Describe the advantages and disadvantages of each course of action in relation to the NBC situation and the employment of chemical assets.
4. **Comparison of courses of action.** Compare all courses of action in relation to advantages and disadvantages.
5. **Recommendation.** Recommend the most advantageous course of action.

Figure D-2. The NBC Staff Estimate

The chemical officer finishes the estimate of the situation with an analysis of the availability of chemical units to conduct decontamination, NBC reconnaissance, and smoke operations. He uses the status of units, their current operations, and completion times for ongoing activities.

The chemical officer provides the G3/S3 the significant assumptions made that could have a major impact upon the whole plan. This ensures that all staff members base their estimates on the same parameters.

### ANALYSIS OF COURSES OF ACTION



The G3/S3 has the lead in analyzing each course of action and identifying the significant factors used in the process. These are usually critical events or actions, such as a passage of lines or the assault and seizure of an objective. The chemical officer, with the rest of the battle staff, assist the G3 /S3 to wargame each course of action against the anticipated enemy action or reaction. The chemical officer identifies advantages and disadvantages for each course of action from the chemical viewpoint.

Shortfalls in chemical resources become apparent during the wargaming process. The chemical officer adjusts the plan to handle these. For every course of action, the NBC defense and smoke plans must meet the commander's requirements. When a critical maneuver event fails due to the lack of chemical resources, the proposed course of action is not feasible.

## **COMPARISON OF COURSE OF ACTION**

The chemical officer compares each course of action and selects the best one from the chemical perspective. That information is provided to the G3/S3 for incorporation into the decision process.

## **RECOMMENDATION**

The chemical officer makes his recommendation to the commander during the decision brief. The type and amount of information briefed depends upon the needs and preferences of the individual commander. In general, the briefing should cover--

- Concept for chemical support.
- Chemical mission priorities.
- Critical NBC and smoke events/actions.
- Task organization and command/support relationships.
- NBC defense and smoke overlay (including smoke, NBC reconnaissance, and decontamination employment and concept of use).

- MOPP levels and where MOPP gear will be stored/carried.
- Critical tasks for subordinate units.
- Vulnerability assessment (including probable targets and agents).
- Levels of risk taken.

Other members of the battle staff brief information provided to them by the chemical officer during the interactive estimate process. This is particularly true of the intelligence portion of the decision briefing and the comparison of courses of action. This information can include, but is not limited to, NBC threat considerations, commander's PIR, or smoke in the deception plan.

## **INTELLIGENCE PREPARATION OF THE BATTLEFIELD**

---

**The IPB process is explained in greater detail in [Appendix E](#). This section discusses the role of the IPB in the planning process.**

---

The intelligence preparation of the battlefield (IPB) normally takes place during the estimate phase. The G2/S2 takes the lead in the IPB, but the entire staff is involved. While the IPB is a five-part process (battlefield area evaluation, terrain analysis, weather analysis, threat evaluation, and threat integration), most of the analysis is conducted prior to the mission or concurrently. The IPB drives the entire planning process. The chemical staff officer provides information and technical advice to the G2/S2 throughout the IPB process. Much of the analysis of the friendly and enemy situation is accomplished within the IPB process.

Weather and terrain information is critical. The chemical officer evaluates the climatic data and the weather forecast to identify factors critical to NBC weapons and smoke employment. Terrain is analyzed for observation, cover and concealment, obstacles, key terrain, and avenues of approach (OCOKA). The impact of terrain on NBC weapons and smoke employment is identified. Areas with deficiencies in natural cover and concealment are identified for possible smoke

operations. Water sources for decontamination operations are identified.

During the threat evaluation phase, the chemical officer provides the G2/S2 an analysis of the enemy's capability to influence the battle using NBC weapons and smoke. After the capabilities of the enemy are determined, the chemical officer must predict how the enemy will likely employ NBC weapons to influence his operation. At the brigade and task force levels the G2/S2 normally develops a situational template for each enemy course of action depicting how the enemy may be arrayed. Once the G2/S2 produces the enemy situational template, the chemical officer provides the G2/S2 an analysis of the enemy's probable employment of NBC weapons and smoke. The chemical officer identifies the probable location/targets for persistent chemical agents and adds them to the template. Trigger points for the execution of nonpersistent strikes are also determined and depicted on the situational or event templates.

After the enemy's most likely course of action is determined, the chemical officer works with the G2/S2 to develop the intelligence collection plan (to confirm the estimate of the enemy's NBC activities at key times and locations). The chemical officer works with the G2/S2 and fire support coordinator (FSCOORD) to identify areas of potential enemy vulnerability and high-value targets (HVTs) for attack with nuclear weapons.

## **COMMANDER'S DECISION**

The commander decides on a course of action and will provide detailed planning guidance to the staff. Detailed warning orders are issued to subordinate chemical units, allowing them to begin preliminary planning. At this point, the chemical officer must have a clear picture of the NBC threat, how chemical units will be employed, and the overall NBC defense plan. If not, seek additional guidance.

## **PREPARE PLANS/ORDERS**

Once the commander has issued his guidance, the staff begins to prepare the plan. Staff coordination is essential during this phase of the planning process. The chemical officer must coordinate with the G3/S3, fire support officer, and the subordinate chemical unit commander. The combat service support (CSS) considerations of the NBC

defense and smoke employment plans are coordinated with the G4/S4. An example of an NBC defense plan is located in [FM 101-5](#). Once the plan is completed, the commander will review & approve or disapprove it.

## ISSUE PLANS/ORDERS

The chemical officer briefs the NBC and smoke plans during the orders briefing. A simple briefing format is used by each staff officer to rapidly provide all necessary information. Subordinate or supporting chemical unit commanders attend the orders briefing to understand the mission, the entire plan, and how the chemical unit fits into the overall operation.

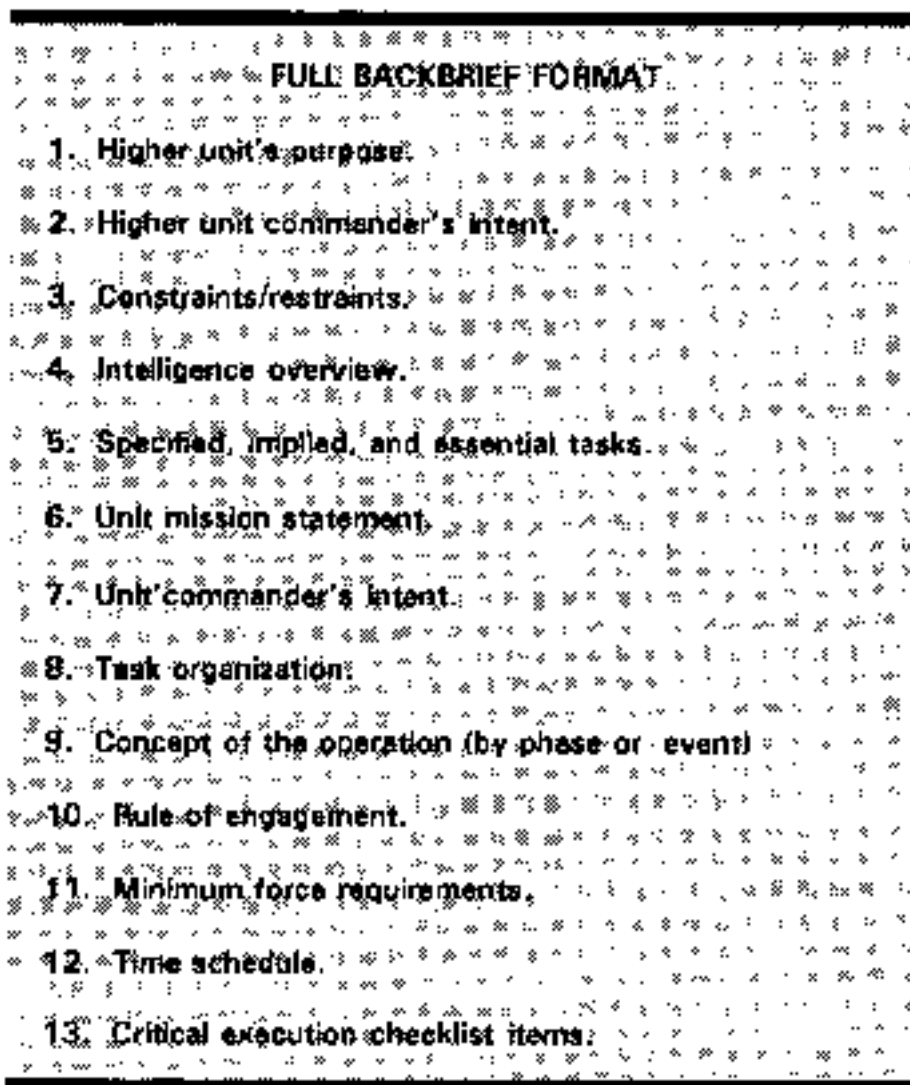

Figure D-3. Full backbrief format.

## SUPERVISE

Planning is a continuous operation. Plans and orders must be adapted or modified based on new information received, rehearsals conducted, and guidance/missions received from higher headquarters. The subordinate or supporting chemical unit commander must provide his plan to the chemical staff officer for review to ensure it meets the commander's intent.

Subordinate units must backbrief their plans/orders to their higher headquarters. This allows the higher commander to ensure that his subordinates have developed their plans/orders in accordance with their concept for the operation. There are two types of backbriefs-- full and abbreviated. When time is not critical, use the full backbrief format ([Figure D-3](#)) and, if time is limited, use the abbreviated backbrief format ([Figure D-4](#)). Chemical units will backbrief their higher or supported units, and chemical staffs will backbrief their higher chemical staffs. Conducting backbriefs promotes the synchronization and integration of plan/orders.

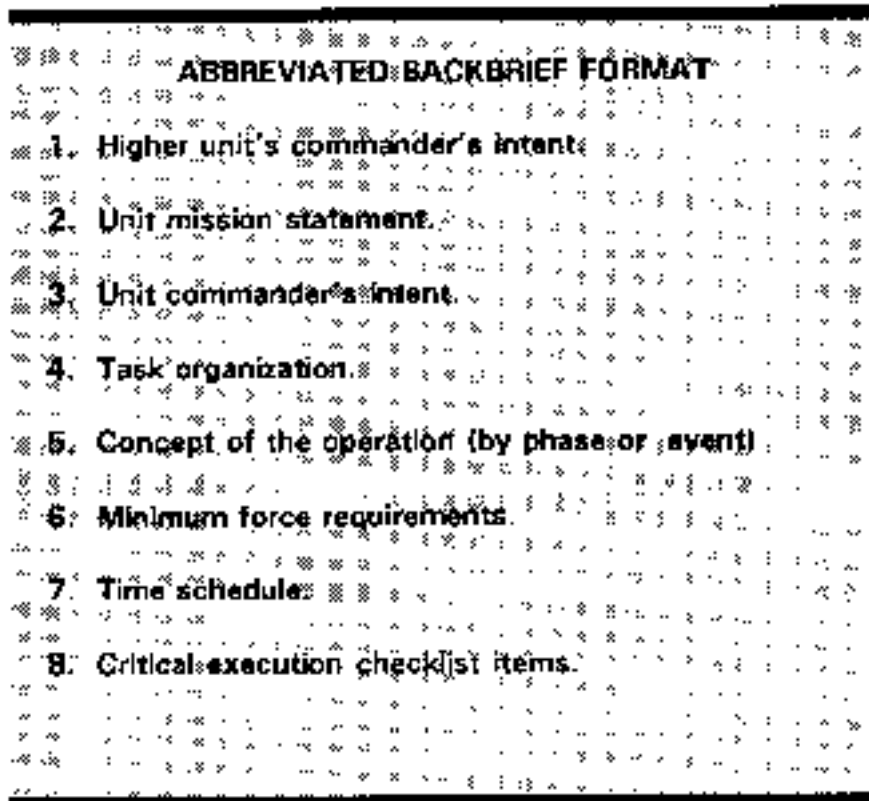

Figure D-4. Abbreviated backbrief format.

[RDL](#)[Table of](#)[Document](#)[Download](#)[Homepage](#) [Contents](#) [Information](#) [Instructions](#)

---

## APPENDIX E

# NBC INTELLIGENCE PREPARATION OF THE BATTLEFIELD

Intelligence Preparation of the Battlefield is a systematic and continuous analysis of the enemy, terrain, and weather for a given area and mission. [FM 34-130](#), *Intelligence Preparation of the Battlefield* outlines the process in detail. IPB is a continuous process which has five phases-- battlefield area evaluation, terrain analysis, weather analysis, threat evaluation, and threat integration.

## BATTLEFIELD AREA EVALUATION

Battlefield area evaluation is the identification of the areas of operation and interest. Here the chemical staff becomes familiar with the unit's area of operation and the assigned mission.

## TERRAIN ANALYSIS

During this phase, the terrain is analyzed to determine its military significance. The S2 determines how the terrain will affect friendly and enemy capabilities, vulnerabilities, and courses of action. The chemical staff considers how the terrain will affect NBC and smoke operations. The chemical staff must not only analyze the terrain for its effects on smoke and agent clouds, but for terrain masking during nuclear operations. They should also look for trafficability for chemical units and the location of water sources. Identification of critical terrain features (for example, defiles/chokepoints, rivers, key terrain) is important. The S2 will develop the combined obstacle overlay and identify avenues of approach and mobility corridors. Without understanding the terrain, the chemical staff cannot predict the effects of chemical agents and smoke.

## WEATHER ANALYSIS

Weather analysis determines its effects on military operations. The chemical staff must obtain detailed weather information such as the temperature, humidity, surface windspeed and direction, and precipitation. They then can determine how the weather will affect the employment of both friendly and enemy NBC and smoke agents. This determination is much more than stating that the winds will favor the enemy's employment. [FM 3-6](#), *Field Behavior of NBC Agents* is an excellent source on how weather affects the employment of smoke and chemical agents. The effect of weather on NBC operations is categorized as unfavorable, moderately favorable, and favorable. [FM 3-6](#) contains two tables that summarize the effects of both terrain and weather on the employment of nonpersistent (vapor and aerosol) and persistent (liquid) chemical agents. [FM 34-81](#), *Weather Support for Army Tactical Operations* outlines the sources for weather reports and provides additional detail on how weather can affect chemical and smoke operations.

## THREAT EVALUATION

In this phase of the IPB, the type and composition of the enemy force in the area of operations is determined. The chemical officer assesses what the enemy's capabilities are to employ NBC weapons and smoke to include types of delivery systems with their ranges. It is also important to review the enemy's NBC and smoke employment doctrine and evaluate it against their mission.

While each enemy force will develop its own chemical employment doctrine, it is possible to classify it into three groups--force-oriented, terrain-oriented, or a combination of the two. The Iraqi military's use of chemical weapons during the Iran-Iraq War was primarily force-oriented. Other threat nations use chemical weapons in both a force and terrain oriented manner. A terrain oriented enemy will attempt to use chemical agents, particularly persistent agents, to restrict terrain or shape the battlefield. [Figure E-1](#) gives an example of a terrain oriented chemical attack. The employment of chemical agents by a force oriented enemy is the attempt to directly target and hit troop concentrations. Both nonpersistent and persistent chemical agents can be used in a force oriented attack. [Figure E-2](#) gives an example of an force oriented chemical attack.

A nuclear-capable enemy will develop its own employment doctrine. This doctrine will be based on many factors to include weapon type, yield, and delivery systems available. How the enemy employs biological weapons is dependent on similar factors-- agent type and delivery systems.

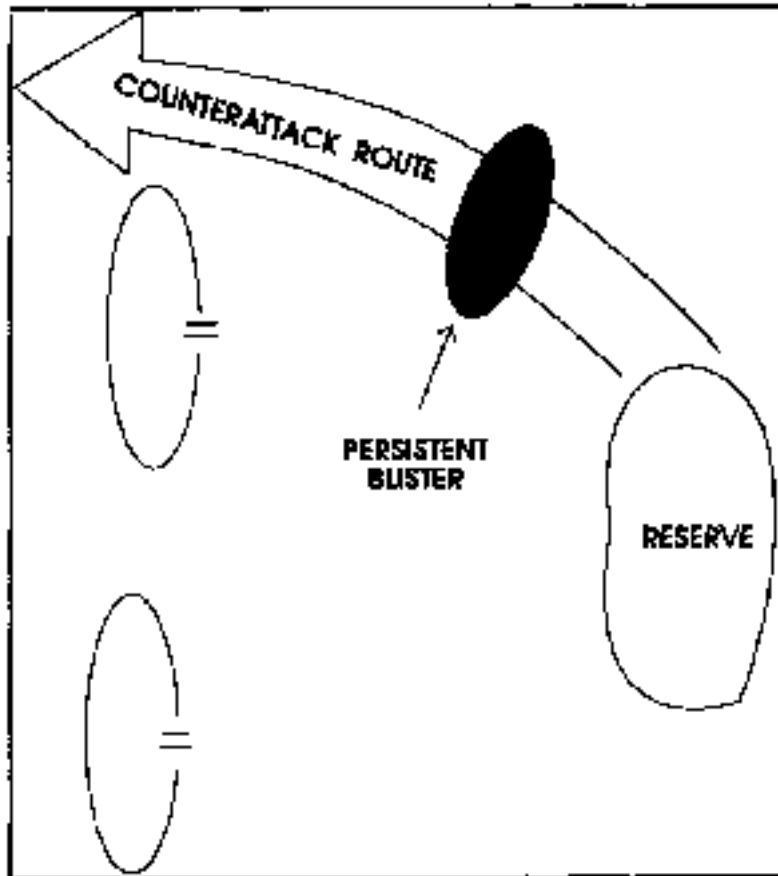

Figure E-1. Example of a terrain oriented chemical attack.

The chemical staff also must consider the enemy's ability to use and see through smoke. The chemical staff must answer these questions:

- How does the enemy use smoke ?
- What type of smoke does he have ?
- How will our smoke affect him ?

The enemy's NBC protective posture must be identified because it may provide indicators of his intent. Troops observed wearing protective gear may indicate an impending attack. During the Iran-Iraq War, the Iraqis never issued friendly chemical strike warnings, but instead



issued warnings that the enemy was about to launch a chemical attack. Enemy soldiers captured without NBC protective equipment could indicate a lower probability of NBC attacks because of an inability to operate in a NBC environment.

The chemical staff also must review recent enemy chemical attacks to understand how he is actually applying his doctrine. Iraqi chemical weapons employment doctrine went through several modifications during the Iran-Iraq War.

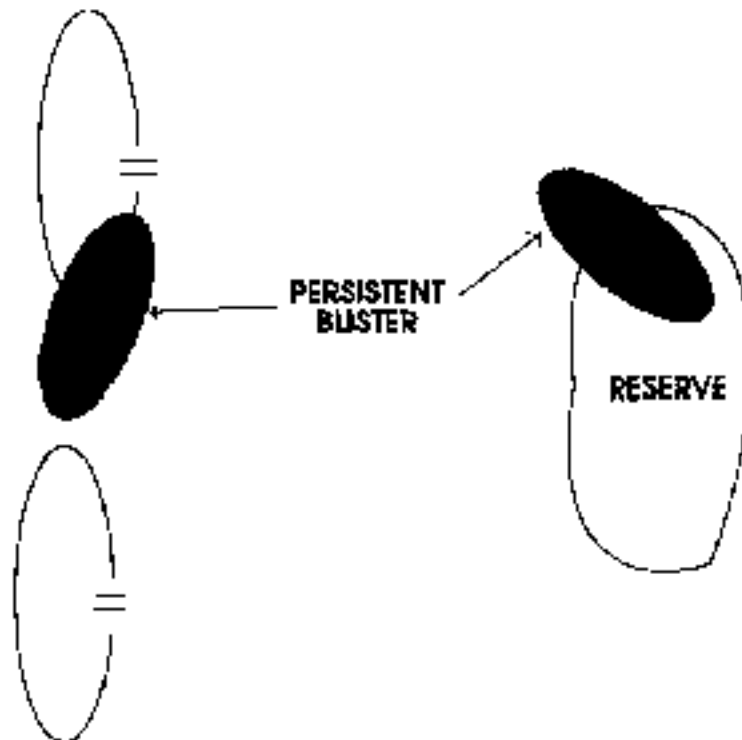

Figure E-2. Example of a force-oriented chemical attack.

## THREAT INTEGRATION

During the threat integration phase, the information developed previously is combined to identify possible enemy courses of action. The product is the situation template (SITEMP). The chemical staff includes where and when the enemy will employ NBC weapons on the SITEMP.

For a terrain-oriented enemy, templating of persistent chemical targets is relatively easy. The chemical staff identifies locations on the SITEMP where the enemy may use persistent chemical agents. When templating a force-oriented enemy, the chemical staff must identify

enemy trigger lines or decision points that the enemy will use to employ his chemical agents ([Figure E-3](#)). During this phase of the IPB, it is critical that the chemical staff and the S2 work together.

## RECONNAISSANCE AND SURVEILLANCE PLANNING

Once the chemical staff has completed the threat integration phase of the IPB, NBC tasks are incorporated into the recon effort to confirm or deny the enemy SITEMP.

Templated persistent targets are designated as Named Areas of Interest (NAI) which are areas or points that will confirm or deny a particular enemy activity. NAIs are shown on the collection plan ([Figure E-4](#)).

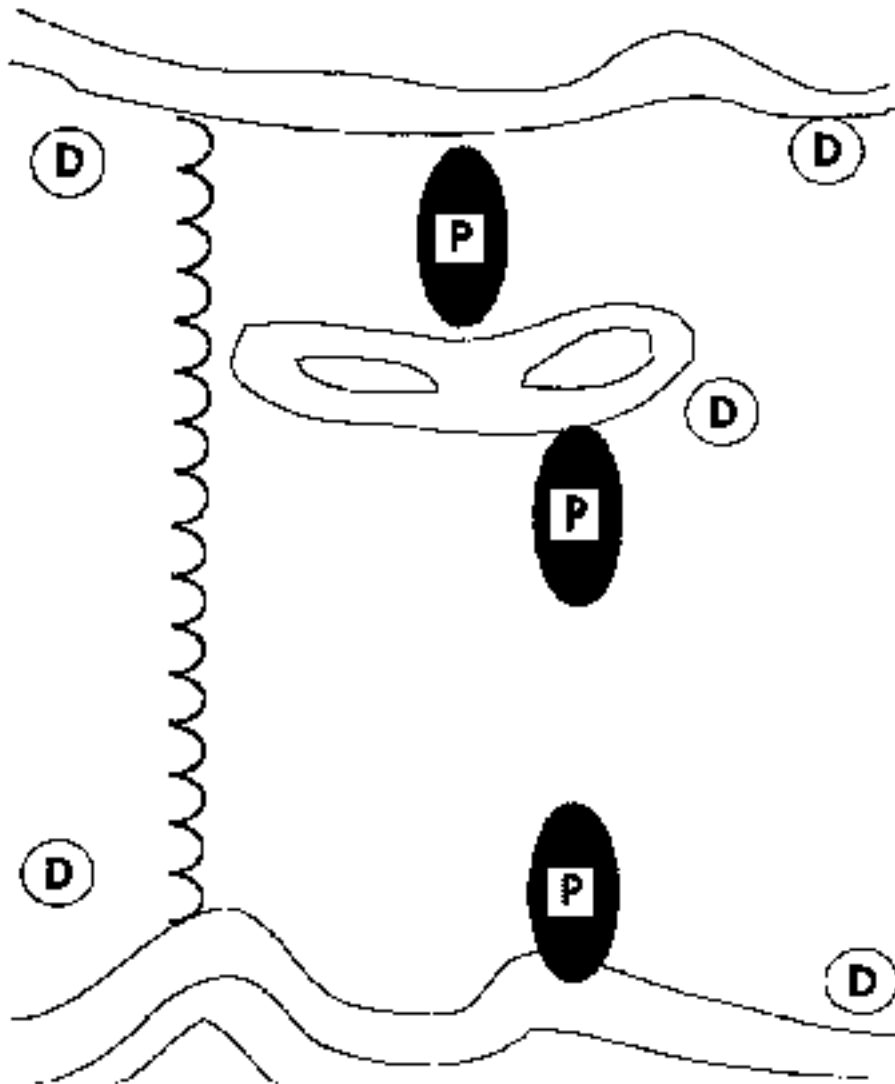

Figure E-3. Templated contaminated areas and decontamination sites.

The collection plan assigns responsibilities for collecting information, to include observing the NAIs. The chemical staff provides the indicators for each NAI. The presence of contamination is an absolute indicator, but it may not be possible to physically reconnoiter the NAI. A unit may be tasked to establish an observation point (OP) to overwatch the NAI. An indicator that chemicals may have been employed is the impacting of artillery within the NAI.

Upon completion of the collection plan, the S2 and the S3 will develop the reconnaissance and surveillance plan (R&S). The chemical staff must assist to develop the collection plan regarding the NBC related NAIs. The R&S plan is given to the units tasked to collect the information. NBC recon tasks are included in the R&S plan. When supported by NBC recon assets, integrate the NBC recon unit into the R&S plan. An example of a collection plan, showing a NBC related PIR, is at [Figure E-4](#).

PIR	INDICATORS	NAI	TIME		SPECIFIC ORDERS OR REQUEST	TASKINGS		
			NET	NLT		44 CHEM	2-1 CAV	1-87 INF
3. Will the enemy use NBC weapons and where & when ?	a. NBC detection equipment	32	2200	0900	check for chem	X		
	b. Movement of chemical munitions forward.	36	2200	0900	report activity	X		
	c. Movement of decon & NBCR vehicles forward.	20	2200	0900	report activity		X	
	d. Low order artillery bursts.	18	2200	0900	report activity			X

Figure E-4. Example of a collection plan.

[RDL](#)[Table of](#)[Document](#)[Download](#)[Homepage](#) [Contents](#) [Information](#) [Instructions](#)

---

## APPENDIX F

# ORDERS AND PLANS

This appendix describes the format of orders and plans used by chemical units to issue their instructions. It also describes the annexes used by chemical staffs to transmit NBC defense instructions.

## WARNING ORDERS

Warning orders are used to notify subordinate units of upcoming operations or missions. The warning order may be an oral or written message. There is no format for warning orders; however, it should contain much of the following--

- Brief description of the situation.
- Mission.
- Time of operation.
- Earliest time of movement.
- Any specific instructions.
- Time and location where the order will be issued.

## OPERATION ORDERS AND PLANS

Chemical units will issue operation orders and plans using the five-paragraph combat order format.

**Task Organization.** This portion lists supporting chemical units under the proper control headquarters. The command or support relationship for each chemical unit is provided.

## 1. Situation.

- a. **Enemy forces.** Provides information on the composition, location, and strength of opposing forces. Concentrates on the enemy capabilities of value to the chemical officer.
- b. **Friendly forces.** Provides information on higher, adjacent, and supporting chemical units.
- c. **Attachments and detachments.** Lists attached and detached units not shown in the task organization.

**2. Mission.** The mission of the supporting chemical elements is clearly stated, including who, what, when, where, and why.

## 3. Execution

**Intent.** A brief paragraph written by the commander that states his vision of the operation, describes the purpose, visualizes the end state, and illustrates how the operation will facilitate future operations.

a. **Concept of the operation.** Clearly states the commander's plan for chemical support. Informs and visualizes the commander's concept. It must be brief and provide sufficient detail to ensure understanding of the commander's intent and purpose. It should specify the general priority of support and the tasks allocated to subordinate units.

b. Subsequent subparagraphs list supporting chemical units numerically. Give specific responsibilities and identify tasks to be performed by each unit.

c. The final subparagraph, "Coordinating Instructions, " details coordination and control applicable to two or more elements of the command.

**4. Service Support.** A statement of combat service support instructions and arrangements for chemical units. It addresses the

materials necessary for decon and smoke operations.

## 5. Command and Signal.

a. **Command.** Specifies command post locations for supported units and chemical units. It designates the succession of chemical staff responsibility and alternate chemical headquarters.

b. **Signal.** Provides instructions for coordinating and establishing communications by different means. The signal operating instructions in effect at the time are listed. Backup means are provided to reestablish communications in case of radio failure.

### Fragmentary Orders

The chemical commander will publish fragmentary orders in fast-paced combat situations. Fragmentary orders are pertinent extracts that provide specific instructions to subordinate commanders or timely changes to existing orders. Fragmentary orders do not have a specified format. However, the five-paragraph combat order is normally used. It includes only necessary elements changed from the original order. The fragmentary order may be issued orally. In general, the fragmentary order--

- Is addressed to each action commander.
- Is addressed to higher and adjacent units for information, as applicable.
- Refers to a previous order, if applicable.
- Includes changes in task organization, situation, and mission, as necessary.
- Clearly provides brief and specific instructions.

### CHEMICAL SUPPORT/NBC DEFENSE ANNEX

Chemical support/NBC defense annexes are prepared by chemical staffs

to issue instructions to subordinate units concerning NBC defense measures and responsibilities. Additionally, subordinate/supporting chemical units may be given missions or taskings in this annex instead of the basic order/plan. The format for this annex is shown below:

ANNEX\_\_\_\_\_ (CHEMICAL SUPPORT/NBC DEFENSE) TO OPORD/OPLAN\_\_\_\_\_

References:

Time Zone Used Throughout the Order/Plan:\_\_\_\_\_

1. SITUATION. Items of information affecting NBC defense not included in paragraph 1 of the OPLAN/OPORD or that need further explanation.

a. Enemy Forces.

(1) *Reference to intelligence annex, if applicable.*

(2) *Enemy NBC capabilities.*

b. Friendly Forces.

(1) *Outline higher headquarters plan.*

(2) *Outline higher and adjacent unit NBC plans.*

(3) *Note additional decon, smoke, NBC reconnaissance, and chemical staff elements supporting the unit.*

c. Attachments and Detachments. *Decon, smoke, NBC reconnaissance, and chemical staff elements are task-organized to include effective times, if appropriate.*

2. MISSION. *A clear, concise statement of the NBC defense task.*

3. EXECUTION.

a. Concept of Operation. *A brief statement of the NBC defense operation to be carried out, to include subordinate/supporting chemical unit tasks/missions and priorities.*

b. NBC Defense Tasks to Subordinate and Supporting Units.

c. Coordinating Instructions.

(1) *Instructions applicable to two or more subordinate/supporting units.*

(2) *References to supporting appendices not referenced elsewhere in the annex.*

(3) MOPP level guidance.

(4) Automatic masking criteria.

(5) Operational exposure guidance (OEG).

(6) Troop safety guidance.

(7) Location of decon sites:

<u>Decon</u> <u>Site</u>	<u>Location</u> —	<u>Type</u> <u>Point</u>	<u>Link Up</u> <u>Point</u>	<u>Link Up</u> <u>Location</u>
-----------------------------	----------------------	-----------------------------	--------------------------------	-----------------------------------

(8) *Procedures for providing support to local population.*

#### 4. SERVICE SUPPORT.

a. *Information about the availability, procedures for distributing, prestock points, and transportation of NBC equipment and chemical defense equipment.*

b. *Procedures for the handling of contaminated casualties and remains, if not established in SOP.*

c. *Information on the availability and location of field expedient decon supplies, materials, and decontaminates.*



## 5. COMMAND AND SIGNAL.

a. Command. *Location of chemical staffs and subordinate/supporting chemical unit headquarters.*

b. Signal.

(1) *Special signal instructions to subordinate/supporting chemical units.*

(2) *Information concerning NBC warning and reporting system (NBCWRS).*

(3) *Information concerning the dissemination of strike warn messages.*

### **MATRIX-TYPE ORDERS**

Matrix-type orders use an execution matrix to convey combat instructions. They are designed to assist the commander and staff to develop an order in a short period. Execution matrices can be used by both chemical unit commanders and chemical staffs.

### **OPERATIONS ORDERS**

DATE/TIME: \_\_\_\_\_

TASK ORGANIZATION (CHANGES ONLY):

MISSION:

COMMANDER'S INTENT:

UNITS EVENT						
CAI SIGN						
FREQ						
MOOP LEVEL	CDR WITH	FA CAL SIGN	CO TRAINS LOC			
RES	ADA STATUS	EMERGENCY SIGNALS				

Figure F-1. Chemical unit execution matrix.

Figure F-1. Chemical unit execution matrix.

**CHEMICAL SUPPORT/NBC DEFENSE ANNEX**

ANNEX: _____ (CHEMICAL SUPPORT) to OPORD _____ DTG _____							
TASK ORGANIZATION (CHANGES ONLY):							
MISSION:							
COMMANDER'S INTENT:							
LINE	PHASE TASK EVENT						
1	NBC THREAT						
2	TEMPLATED THREAT						
3	KNOWN THREAT						
4	DECON SITE  LINK UP POINT						
5	DECON PLATOON						
6	SMOKE PLATOON						
7	NBC RECON PLATOON						
8	MOPP LEVEL						
9	CEG						

8	MOPP LEVEL					
9	OEG					
REMARKS:						

Figure F-2. NBC defense/chemical support execution matrix.



[RDL](#) [Table of Contents](#) [Document](#) [Download](#)

[Homepage](#) [Contents](#) [Information](#) [Instructions](#)

---

## GLOSSARY ACRONYMS AND DEFINITIONS

**AA** - air assault

**abn** - airborne

**ACR** - armored cavalry regiment

**ADC** - area damage control

**ADP** - automatic data processing

**AM** - amplitude modulation

**ANBACIS** - Automated Nuclear, Biological, and Chemical Information System

**AO** - area of operations

**AOE** - Army of Excellence

**Area damage control** - measures taken before, during, and after hostile actions or natural or man-made disasters to reduce the probability of damage and to minimize its effects. Also called ADC

**area of operations** - that portion of an area of conflict necessary for military operations. Areas of operations are geographic areas assigned to commanders for which they have responsibility and in which they have authority to conduct military operations.

**ART** - assessment and recovery team

**ARTEP** - Army training and evaluation program

**ASG** - Area support group

**A2C2** - Army air control center

**battlefield circulation control** - a military police mission involving route reconnaissance and surveillance, main supply route regulation/enforcement, straggler and refugee control, and information dissemination.

**BBSO** - brigade/battalion signal officer

**BCG** - battlefield circulation control

**bde** - brigade

**bn** - battalion

**brigade support area** - a designated area in which combat service support elements from division support command and corps support command provide logistic support to a brigade. It normally is located 20 to 25 kilometers behind the forward edge of the battle area.

**BSA** - brigade support area

**CAA** - combined arms army

**CFA** - covering force area

**CINC** - commander-in-chief

**CP** - command post

**CAB** - combat aviation battalion

**CB** - chemical and biological

**CDE** - chemical defense equipment

**CE** - communication-electronics

**chemical warfare** - the employment of chemical agents to (1) kill, injure, or incapacitate man or animals for a significant period or (2) deny or hinder the use of areas, facilities, or materiel.

**cm** - chemical

**co** - company

**CONUS** - continental United States

**combat service support** - the assistance provided to sustain combat forces, primarily in the fields of administration and logistics. It includes administrative services, chaplain services, civil affairs, food services, finance, legal services, maintenance, medical services, supply, transportation, and other logistical services.

**combat support** - fire support and operational assistance provided to combat elements. It includes artillery, air defense artillery, engineer, military police, signal, military intelligence, and chemical.

**command post** - the principal facility employed by the commander to command and control combat operations. It consists of those coordinating and special staff activities and representatives from supporting Army elements and other services that may be necessary to carry out operations. Corps and division headquarters are particularly adaptable to organization by echelon into tactical, main, and rear command posts.

**communications security** - the protection resulting from all measures designed to deny unauthorized persons information of value that might be derived from the possession and study of telecommunications, or to mislead unauthorized persons in their interpretation of the results of such possession and study. Includes cryptosecurity, transmission security, emission security, and physical security of communications security materials and information.

**possession and study.** Includes cryptosecurity, transmission security, emission security, and physical security of communications security materials and information.

**COMMZ - communications zone**

---

**CO\$COM - corps support command**

**CP - command post**

**CRN - combat radio net**

**CS - combat support**

**CSA - corps support area**

**CSG - Corps support group**

**CSS - combat service support**

**CT - communications terminal**

**decon - decontamination**

**DED - detailed equipment decon**

**def - defense**

**det - detachment**

**direct support -** a mission requiring a force to support another specific force and authorizing it to answer directly the supported force's request for assistance. In NATO, the support provided by a unit or formation not attached to, nor under command of, the supported unit or formation but required to give priority to the support required by that unit or formation.

**DISCOM - division support command**

**div - division**

**DIVARTY - division artillery**

**division support area -** an area normally located in the division rear positioned near air-landing facilities and along the main supply route. It contains the DISCOM command post, the headquarters elements of the DISCOM battalions, and those DISCOM elements charged with providing backup support to the combat service support elements in the brigade support area and direct support (DS) to units located in the division rear. Selected corps support command elements may be located in the division support area to provide DS backup and general support.

**DMMC - division materiel management center**

**DNVT - digital nonsecure voice terminal**

**DS - direct support**

**DSA - division support area**

**DSU - direct support units**

**DSU** - direct support units

**DTD** - detailed troop decon

---

**echelons above corps** - Army headquarters and organizations that provide the interface between the theater commander (joint or combined) and the corps for operational matters, and between the continental United States/host nation and the deployed corps for combat service support (CSS). Operational echelons above corps may be United States only or allied headquarters, while echelons above corps for CSS will normally be US national organizations.

**electronic warfare** - the use of electromagnetic energy to determine, exploit, reduce, or prevent hostile use of the electromagnetic spectrum and to ensure friendly use thereof.

**FAIQ** - field artillery intelligence officer

**FEBA** - forward edge of the battle area

**FFSP** - forward fuel (fog oil) supply point

**fire support coordinator** - the senior field artillery officer at each echelon above maneuver platoon level who serves as the principal advisor to the commander for the planning and coordination of all available fire support.

**fire support element** - a functional portion of a force tactical operations center that provides centralized targeting, coordination, and integration of fires delivered on surface targets by fire support means under the control of or in support of the force. This element is staffed from the field artillery headquarters of field artillery staff section of the force and representatives of other fire support means.

**FLOT** - forward line of our troops

**FM** - frequency modulation

**forward edge of the battle area** - the forward limit of the main battle area.

**FMSP** - foreign military sale program

**forward line of own troops** - a line that indicates the most forward positions of friendly forces in any kind of military operation at a specific time. It may be at or beyond the FEBA, depicting the nonlinear battlefield.

**fragmentary order** - an abbreviated form of an operation order used to make changes in missions to units and to inform them of changes in the tactical situation.

**FRAGO** - fragmentary order

**FSB** - forward support battalion

**FSE** - fire support element

**FTS** - field training services

**gen** - generator

**general support** - that support given to the supported force as a whole and not to any particular



**general support** - that support given to the supported force as a whole and not to any particular subdivision thereof.

**G1** - assistant chief of staff (personnel)

**G2** - assistant chief of staff (intelligence)

---

**G3** - assistant chief of staff (operations and plans)

**G4** - assistant chief of staff (logistics)

**G5** - assistant chief of staff (civil affairs)

**GS** - general support

**HHC** - headquarters and headquarters company

**HHD** - headquarters and headquarters detachment

**HNS** - host nation support

**HVT** - high-value targets

**hvy** - heavy

**IMETP** - International Military Education and Training Program

**IPB** - Intelligence preparation of the battlefield

**IR** - intelligence requirements

**LD** - line of departure

**LDF** - lightweight digital facsimile

**LDS** - lightweight decontamination system

**LENS** - large extension node switch

**LNO** - liaison officer

**LOGPAC** - logistics package

**LRP** - logistical release point

**LZ** - landing zone

**MBA** - main battle area

**MACOM** - major Army command

**MBA** - main battle area

**main battle area** - that portion of the battlefield extending rearward from the forward edge of the battle area (FEBA) and in which the decisive battle is fought to defeat the enemy attack. It includes the use of lateral and rear boundaries. For any particular command, this area extends from the FEBA to the

area (FEBA) and in which the decisive battle is fought to defeat the enemy attack. It includes the use of lateral and rear boundaries. For any particular command, this area extends from the FEBA to the rear boundaries of those units comprising its main defensive forces.

---

**main command post** - consists of those staff activities involved in controlling and sustaining current operations and in planning future operations. It normally operates under control of the chief of staff. In addition it consists of G1, G2, G3, and G4 elements, fire support and chemical elements; tactical air control party element; and an Army airspace command and control element consisting of air defense artillery and Army aviation staff elements. The main command post exercises command and control of the current operation in cases where a tactical command post is not employed.

**main supply route** - the route or routes designated within an area of operations on which the bulk of traffic flows in support of military operations.

**MCT** - movement control team

**MDMP** - military decisionmaking process

**mech** - mechanized

**METL** - mission-essential task list

**METT-T** - mission, enemy, terrain, troops, and time available

**MMC** - materiel management center

**MOPP** - mission-oriented protective posture

**MRC** - motorized rifle company

**MRD** - motorized rifle division

**MSB** - main supply battalion

**MSC** - major subordinate commands

**MSE** - Mobile subscriber equipment

**MSR** - main supply route

**MSRT** - mobile subscriber radiotelephone terminal

**MTOE** - modified table of equipment

**MTT** - mobile training team

**mtz** - motorized

**M/CM** - mobility and countermobility

**NAI** - named areas of interest

**NAI** - named areas of interest

**NBC** - nuclear, biological, and chemical

**NBCC** - nuclear, biological, and chemical center

**NBCE** - nuclear, biological, and chemical element

**NBCRS** - nuclear, biological, and chemical reconnaissance system

---

**NBCWRS** - nuclear, biological, and chemical warning and reporting system

**NBSCC** - nuclear, biological, and chemical subcollection center

**NCA** - National Command Authority

**NCS** - net control station

**NCO** - noncommissioned officer

**NEA** - Northeast Asia

**nuclear, biological, and chemical** - the methods, plans, procedures, and training required to establish defense measures against the effects of an attack by NBC weapons.

**OCOKA** - observation, cover, and concealment, obstacles, key terrain, and avenues of approach

**OEG** - operational exposure guidance

**OP** - observation post

**OPCON** - operational control

**operation order** - a directive issued by a commander to subordinate commanders for effecting the coordinated execution of an operation; includes tactical movement orders.

**operation plan** - a plan for a military operation. It covers a single operation or a series of connected operations to be carried out simultaneously or in succession. It implements operations derived from the campaign plan. When the time and/or conditions occur under which the plan is to be placed in effect, the plan becomes an operation order.

**operational control** - the authority delegated to a commander to direct forces assigned so that the commander may accomplish specific missions or tasks that are usually limited by function, time, or location; to deploy units concerned; and to retain or assign tactical control of those units. It does not of itself include administrative or logistic control. In NATO, it does not include authority to assign separate employment of components of the units concerned.

**operational exposure guidance** - the maximum amount of nuclear radiation which the commander considers his unit may be permitted to receive while performing a particular mission.

considers his unit may be permitted to receive while performing a particular mission.

**operations security** - all measures taken to maintain security and achieve tactical surprise. It includes countersurveillance, physical security, signal security, and information security. It also involves the identification and elimination or control of indicators that can be exploited by hostile intelligence organizations.

**OPCON** - operational control

**OPSEC** - operations security

**PDDA** - power-driven decontamination apparatus

**PDDE** - power-driven decontamination equipment

**PIR** - priority intelligence requirements

**POL** - petroleum, oils, and lubricants

**Posse Comitatus Act** - prohibits federal military forces from giving law enforcement assistance to civil authorities unless authorized by Congress.

**R&S** - reconnaissance and surveillance

**RAOC** - rear area operations center

**RATT** - radio teletypewriter

**RAU** - radio access units

**RCA** - riot control agents

**rear area operations center** - the control center responsible for planning, coordinating, directing, and mounting rear operations.

**rear command post** - consists of those staff activities concerned primarily with combat service support of the force, administrative support of the headquarters, and other activities not immediately concerned with current operations. Typical representatives within the rear echelon are elements of the G1 and G4 sections, G5, adjutant general, staff judge advocate, inspector general, and provost marshal; supporting military intelligence elements concerned with counterintelligence and prisoner of war interrogation activities; and the tactical airlift representative of the tactical air control party. Normally, rear command posts are near or collocated with combat service support units.

**recon** - reconnaissance

**RMC** - remove multiplexer combiner

**RTOC** - Rear tactical operations center

**RWI** - radio wire integration

**SATP** - security assistance training program

**SF** - Special Forces

**SENS** - small extension node switch

**SENS** - small extension node switch

**SFFP** - smoke forward fuel point

**SFOOA** - Special Forces Operational Detachment--Aloha

**SG** - smoke generator

**signal security** - measures intended to deny or counter hostile exploitation of electronic emissions. It includes communications security and electronic security.

**SITEMP** - situation template

**SITREP** - situation report

**SJA** - Staff Judge Advocate

---

**smk** - smoke

**SOP** - standing operating procedure

**SOI** - Signal Operating Instructions

**SOTI** - security, operations, training, and intelligence

**SDT** - skill development test

**BWA** - Southwest Asia

**TA** - theater army

**TAACOM** - theater army area command

**TAC** - tactical

**tactical command post** - the forward echelon of a Headquarters. It may consist of G2, G3, fire support, tactical air control party, air defense artillery, and combat service support liaison (G1, G4) elements. It is located well forward on the battlefield so that the commander is in proximity to subordinate commanders and can directly influence operations. At division, it is located within FM radio range of the committed brigades.

**tactical operations center** - the element within the main command post consisting of those staff activities involved in sustaining current operations and in planning future operations. Staff activities are functionally grouped into elements or cells.

**TASE** - tactical air support element

**TCF** - tactical combat force

**TCOO** - Tactical Chemical Operations Officer

**TF** - task force

**TOC** - tactical operations center

**TOC** - tactical operations center

**TOE** - table of organization and equipment

**UCMJ** - Uniform Code of Military Justice

**UHF** - ultrahigh frequency

**UMT** - Unit Ministry Team

**US** - United States

**XO** - Executive Officer

[RDL](#)[Table of](#)[Document](#)[Download](#)[Homepage](#) [Contents](#) [Information](#) [Instructions](#)

---

## REFERENCES

### SOURCES USED

These are the sources quoted or paraphrased in this publication.

### Joint and Multiservice Publications

[FM 3-3](#)/[FMFM 11-17](#), *Chemical/Biological Contamination Avoidance*, Nov 1992.

[FM 3-3-1](#)/[FMFM 11-18](#), *Nuclear Contamination Avoidance*, (final draft).

[FM 3-4](#)/[FMFM 11-9](#), *NBC Protection*, May 1992.

[FM 3-5](#)/[FMFM 11-10](#), *NBC Decontamination*, (final draft).

[FM 3-6](#)/[AFM 105-7](#)/[FMFM 7-11-H](#), *Field Behavior of NBC Agents (Including Smoke and Incendiaries)*, Nov 1986.

[FM 3-19](#)/[FMFM 11-20](#), *NBC Reconnaissance*, (to be published in late 1993).

[FM 3-100](#)/[FM FM 11-2](#), *NBC Defense, Chemical Warfare, Smoke, and Flame Operations*, May 1991.

[FM 34-81](#)/[AFM 105-4](#), *Weather Support for Army Tactical Operations*, Aug 1989.

[FM 100-19](#)/[FMFM 7-10](#), *Domestic Support Operations*, Jul 1993.

### Army Publications

**FM 3-18**, *Special NBC Reconnaissance (LB Team)*, May 1993.

[FM 3-50](#), *Smoke Operations*, Dec 1990.

[FM 5-100](#), *Engineer Combat Operations*, Nov 1988.

[FM 8-10-7](#), *Health Service Support in a Nuclear Biological, and Chemical Environment*, Apr 1993.

**FM 11-30**, *MSE Communications in the Corps/Division*, Feb 1991.

[FM 11-32](#), *Combat Net radio Operations*, Oct 1990.

**FM 11-37**, *MSE Primer for Small-Unit Leader*, Nov 1990.

**FM 24-1**, *Signal Support in the Airland Battle*, Oct 1990.

[FM 34-130](#), *Intelligence Preparation of the Battlefield*, May 1989.

[FM 71-100](#), *Division Operations*, Jun 1990.

**FM 71-100-1**, *Armored and Mechanized Division Operations - Tactics, Techniques, and Procedures*, coordinating draft.

**FM 90-14**, *Rear Battle*, Jun 1985.

[FM 100-5](#), *Operations*, Jun 1993.

[FM 101-5](#), *Staff Organization and Operations*, May 1984.

[FM 101-5-1](#), *Operational Terms and Symbols*, Oct 1985.

[FM 100-15](#), *Corps Operations*, Sep 1989.

**USACGSC ST 100-9**, *The Tactical Decisionmaking Process*, Jul 1992.



## Nonmilitary Publications

**National Training Center**, *Brigade Training Team Observations, Volume 3 - Decontamination-Planning and Execution*, 1991.

**National Training Center**, *Orders Guide*, 1990.

## DOCUMENTS NEEDED

These documents must be available to the intended users of this publication.

**DA Form 2028**. *Recommended Changes to Publications and Blank Forms*. Feb 1974.

## READINGS RECOMMENDED

These reading contain relevant supplemental information.

[FM 3-3](#)/**FMFM 11-17**, *Chemical/Biological Contamination Avoidance*, Nov 1992,

**FM 3-3-1**/**FMFM 11-18**, *Nuclear Contamination Avoidance*, (to be published in 1994).

[FM 3-4](#)/**FMFM 11-9**, *NBC Protection*, May 1992.

[FM 3-5](#)/**FMFM 11-10**, *NBC Decontamination*, (to be published in 1993).

[FM 3-6](#), *Field Behavior of NBC Agents (Including Smoke and Incendiaries)*, Nov 1986.

**FM 3-18**, *Special NBC Reconnaissance (LB Team)*, May 1993.

[FM 3-19](#)/**FMFM 11-20**, *NBC Reconnaissance*, (to be published in late 1993).

[FM 3-50](#), *Smoke Operations*, 4 Dec 1990.

[FM 3-100](#)/[FMFM 11-2](#), *NBC Defense, Chemical Warfare, Smoke, and Flame Operations*, May 1991.

[FM 63-1](#), *Combat Service Support Operations, Separate Brigade*, Sep 1983.

[FM 63-2](#), *Division Support Command, Armored, Infantry, and Mechanized Infantry Divisions*, May 1991.

[FM 63-3](#), *Combat Service Support Operations - Corps (How to Support)*, Aug 1983.

[FM 63-4](#), *Combat Service Support Operations - Theater Army Command*, Sep 1984.

[FM 63-3J](#), *Combat Service Support Operations - Corps*, Aug 1985.

[FM 100-5](#), *Operations*, Jun 1993.

[FM 100-19](#)/[FMFM 7-10](#), *Domestic Support Operations*, Jul 1993.

[FM 100-37](#), *Terrorism Counteraction*, Jul 1987.



[RDL](#)

[Table of](#)

[Document](#)

[Download](#)

[Homepage](#)

[Contents](#)

[Information](#)

[Instructions](#)

FM 3-101  
19 NOVEMBER 1993

By Order of the Secretary of the Army:

Official:

MILTON H. HAMILTON  
*Administrative Assistant to the  
Secretary of the Army*

03452

GORDON R. SULLIVAN  
*General, United States Army  
Chief of Staff*

**DISTRIBUTION:**

**Active Army, USAR, and ARNG: To be distributed in accordance with DA Form 12-11E, requirements for FM 3-101, Chemical Staffs and Units (Qty rqr block no. 3031)**

